

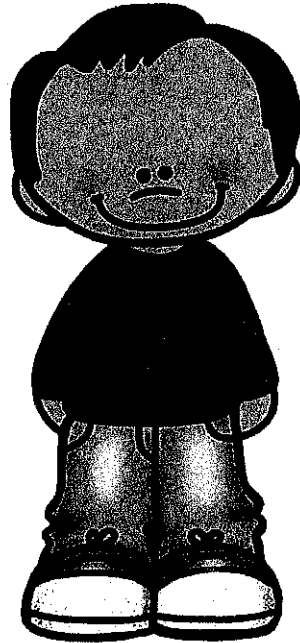











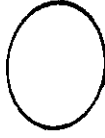
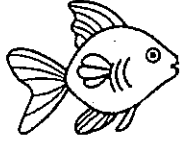
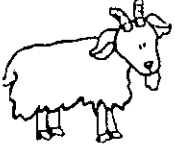

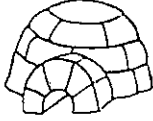

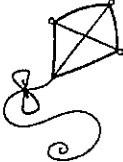



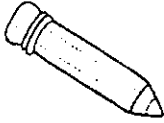

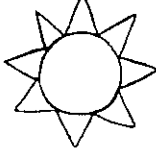
# Preschool Learning Folder

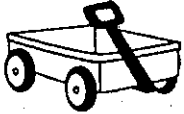

Name: \_\_\_\_\_

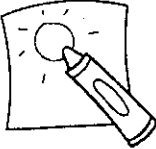
# I Know My Alphabet

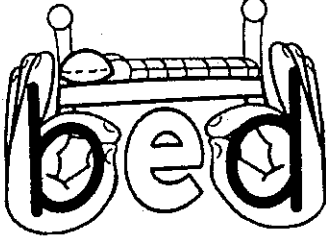
Aa 	Bb 	Cc 	Dd 	Ee 	Ff 	Gg 
Hh 	Ii 	Jj 	Kk 	Ll 	Mm 	Nn 
Oo 	Pp 	Qq 	Rr 	Ss 	Tt 	Uu 
Vv 	Ww 	Xx  	Yy 	Zz 		

©thisreadingmama.com

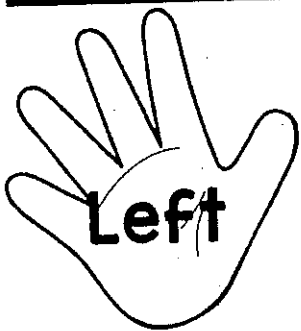

## I Know My First Name



---

---

---

# I Know How to Rhyme

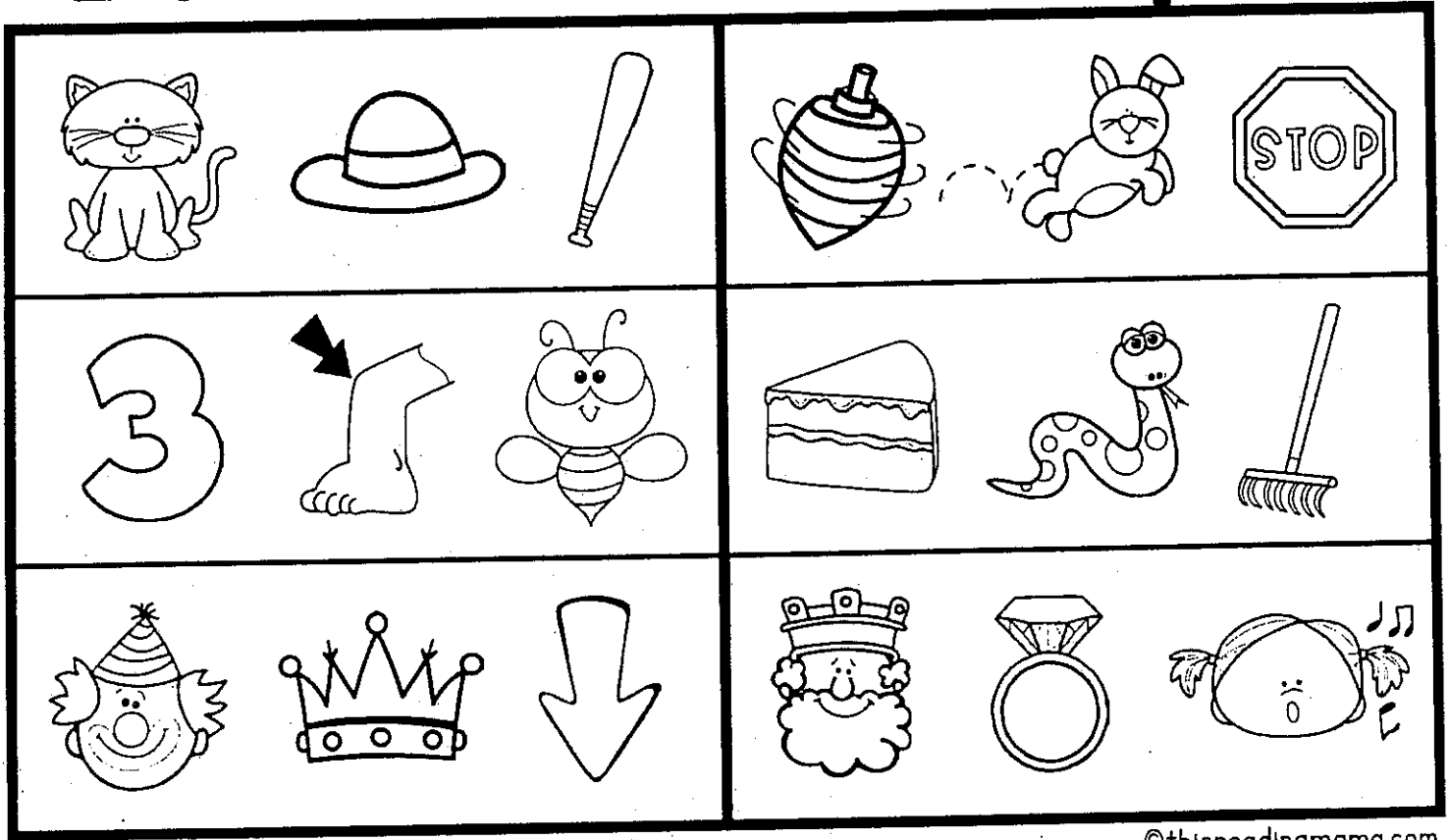





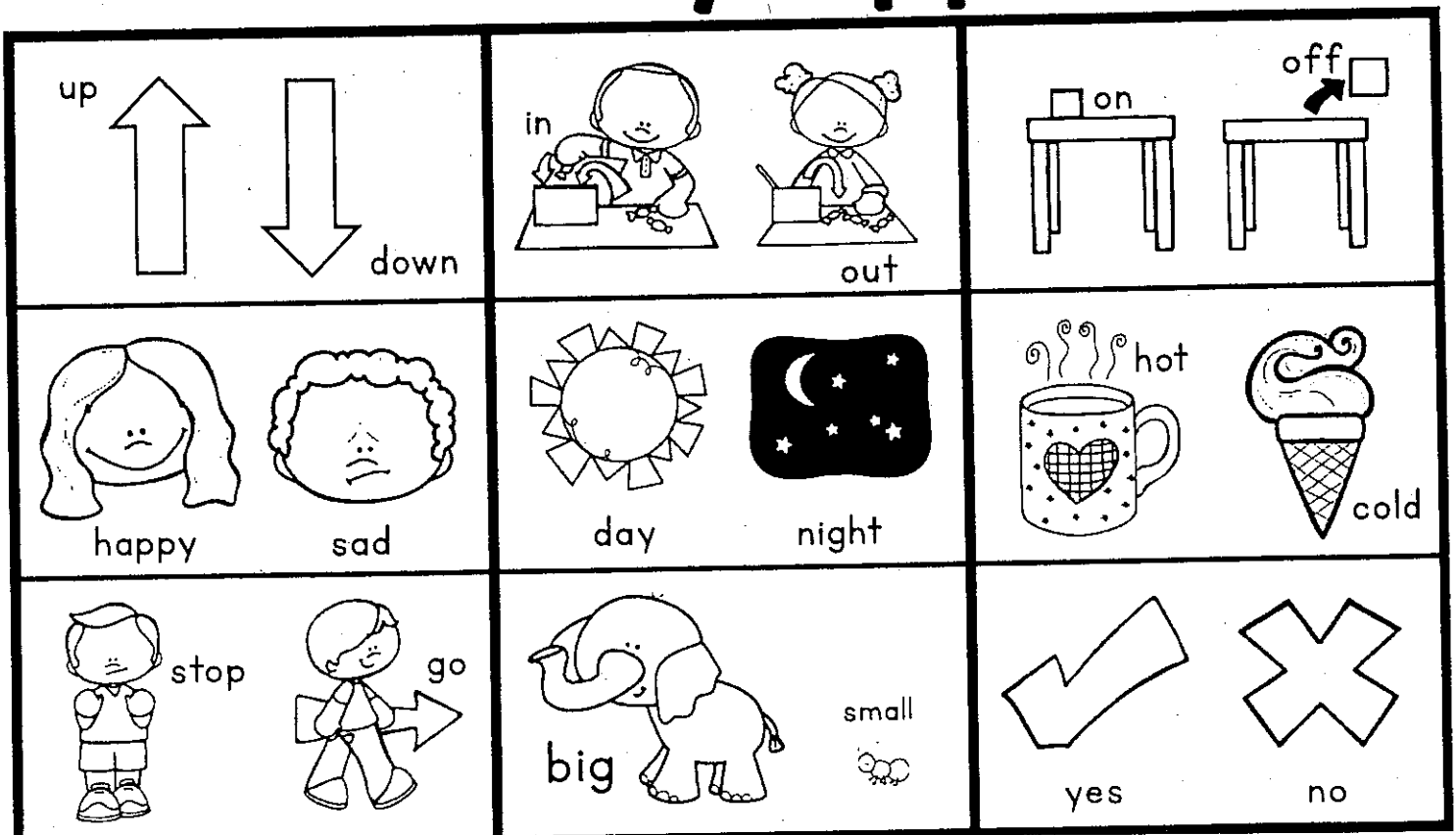

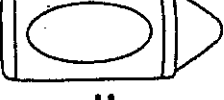

©thisreadingmama.com

# I Know My Opposites

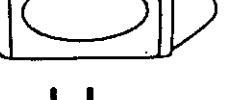

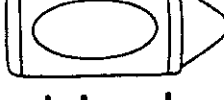

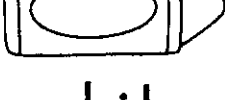

# I Know My Colors

 red	 orange	 yellow	 green	 blue
 purple	 pink	 black	 brown	 white

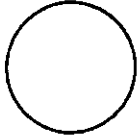
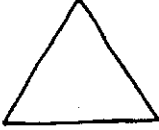
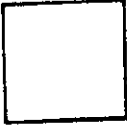
©thisreadingmama.com

# I Know My Shapes

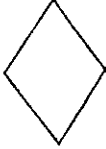
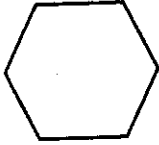
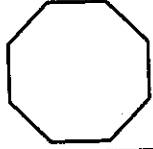
circle 	triangle 	square 	rectangle 	oval 
heart 	star 	diamond 	hexagon 	octagon 

0

# I Know My Numbers

1	2	3	4	5	6	7	8	9	10
11	12	13	14	15	16	17	18	19	20
21	22	23	24	25	26	27	28	29	30

# **BLACKLINE ALPHABET FUN PAGES**

# FUN PAGE

www.thisreadingmama.com

Letter

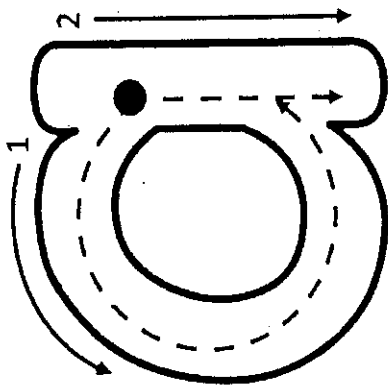

Find

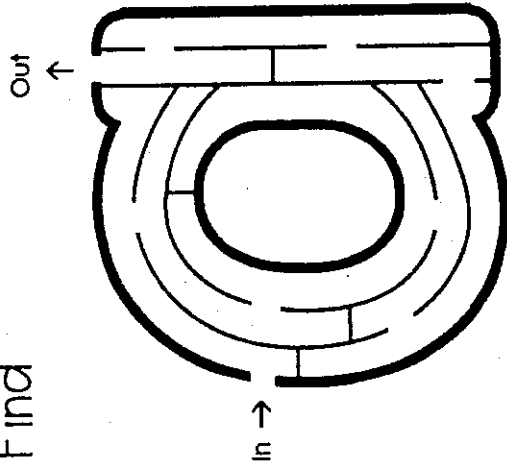

Connect

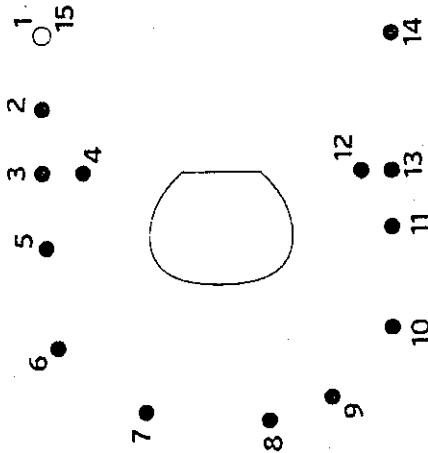

Color

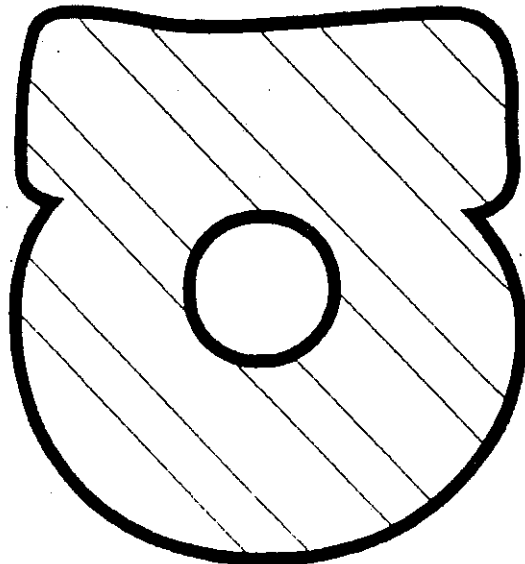

Trace

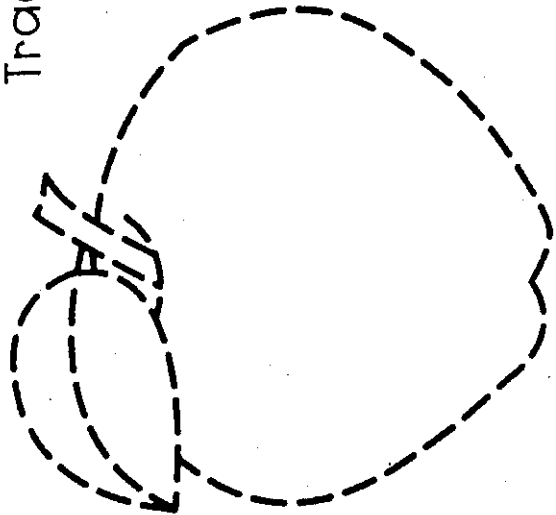

a is for  
**apple**

# FUN PAGE

www.thisreadingmama.com

Letter

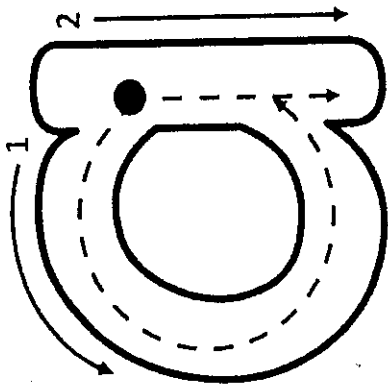

Color

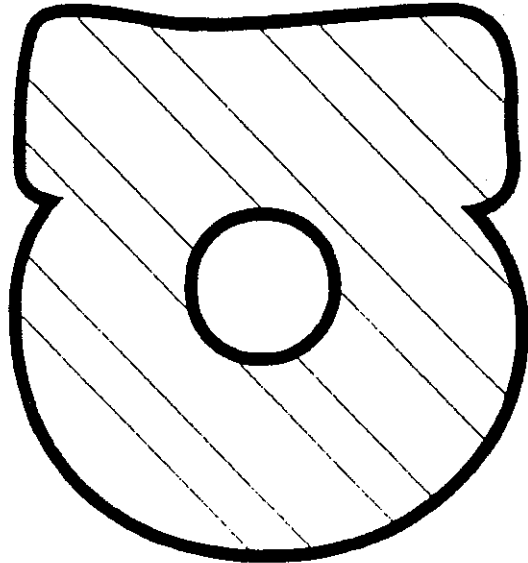

Find

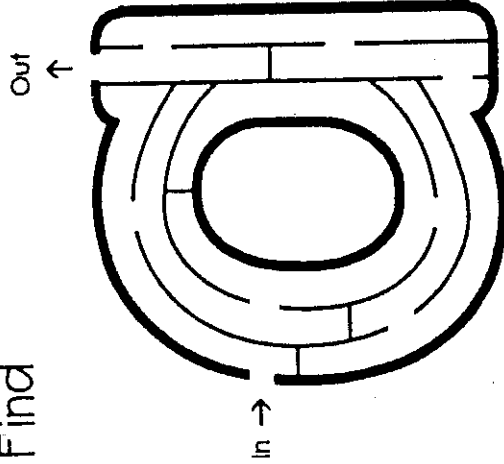

Connect

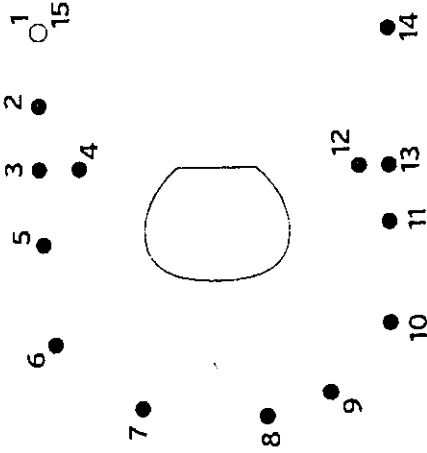

Trace

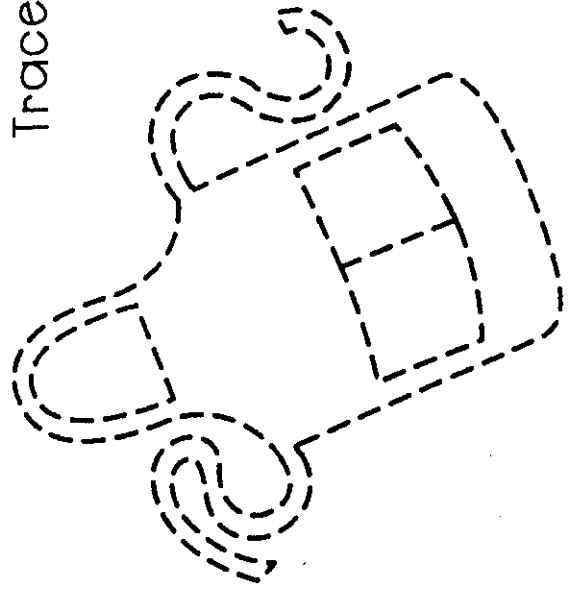

**a** is for  
**apron**

# FUN PAGE

www.thisreadingmama.com

Letter

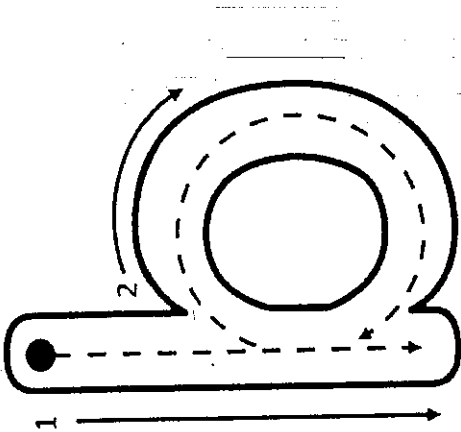

Color

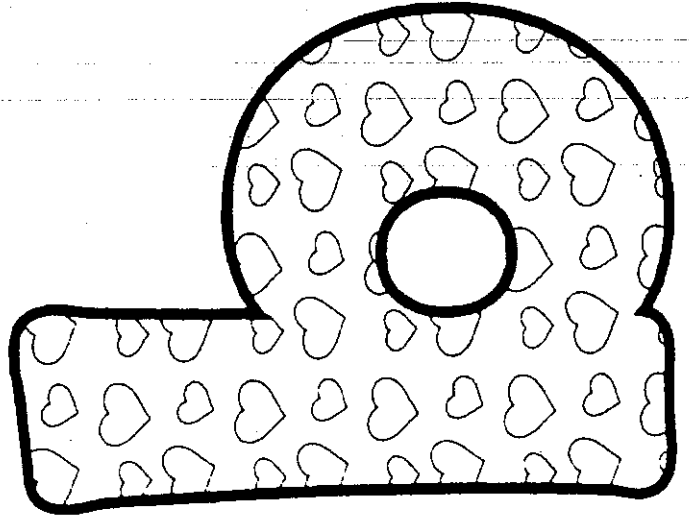

Find

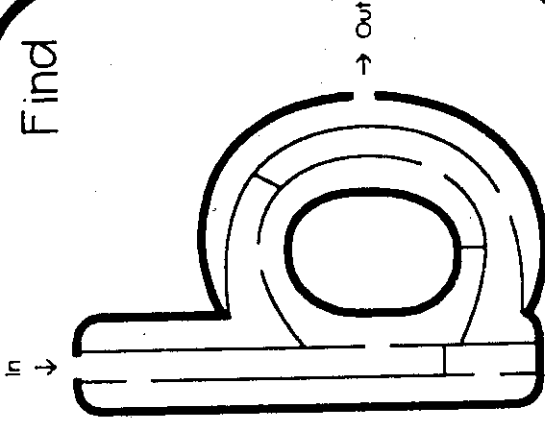

Connect

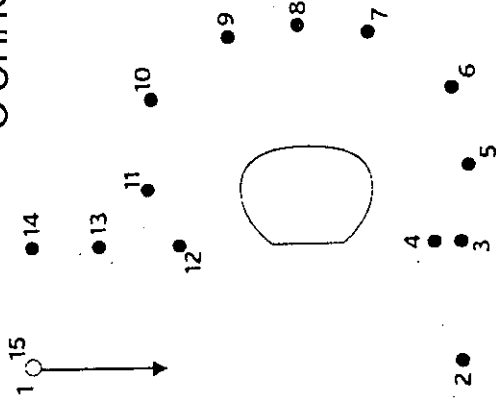

Trace

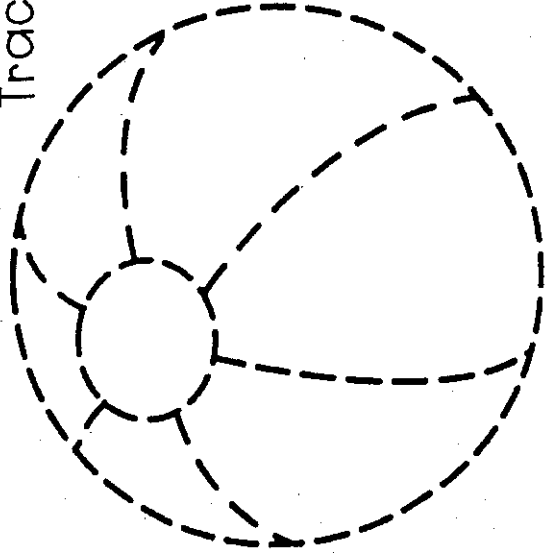

**b** is for  
**ball**



# FUN PAGE

Letter

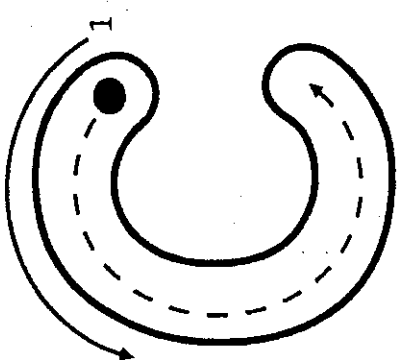

Find

Out ↑

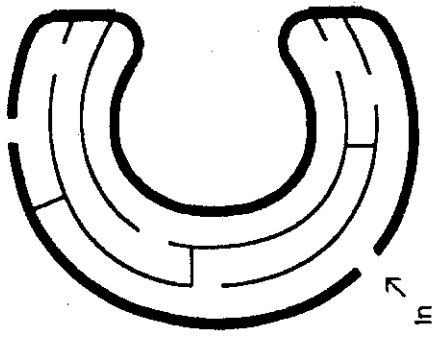

Connect

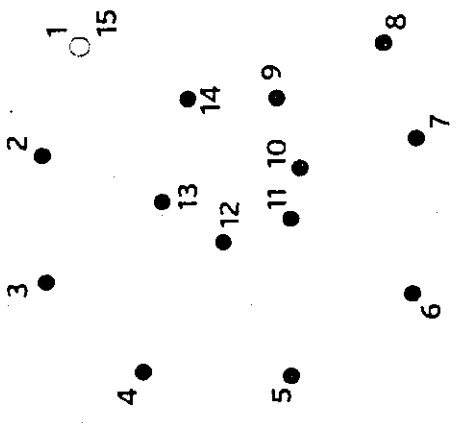

Color

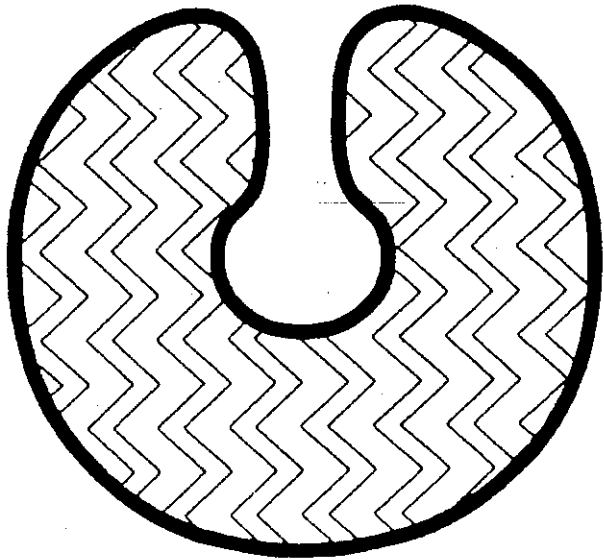

Trace

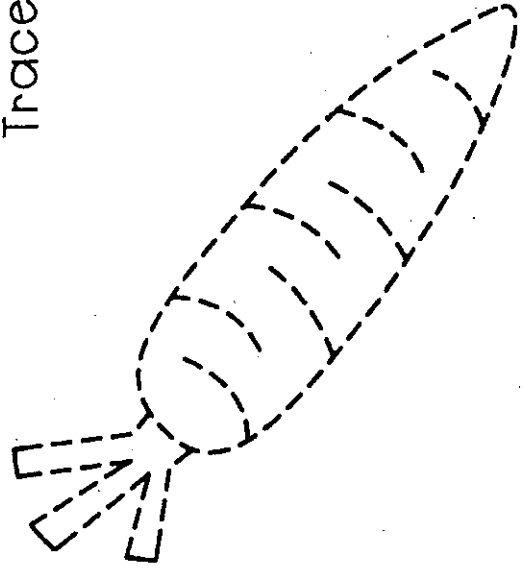

c is for  
carrot

# FUN PAGE

www.thisreadingmama.com

Letter

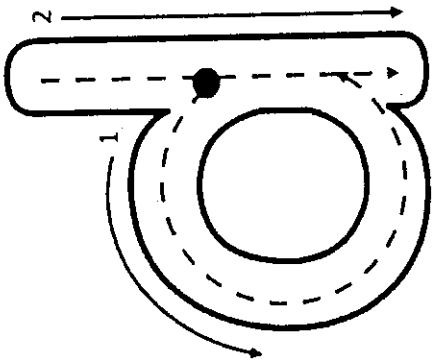

Find

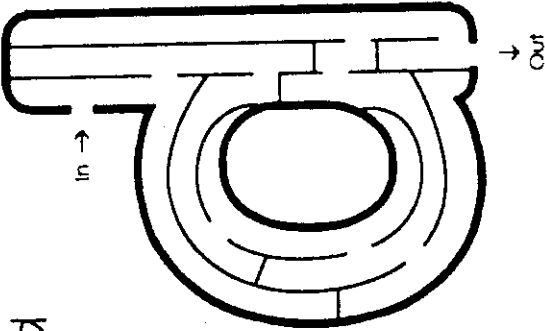

Connect

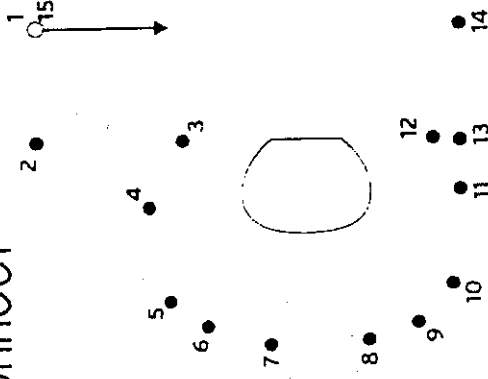

Color

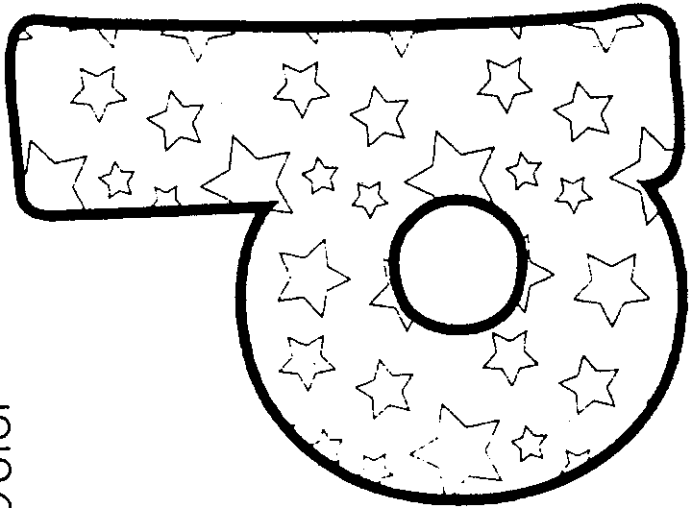

Trace

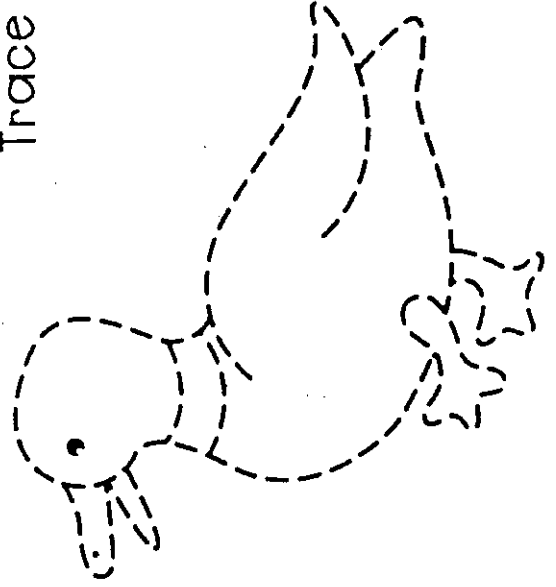

**d** is for  
**duck**

# FUN PAGE

www.thisreadingmama.com

Letter

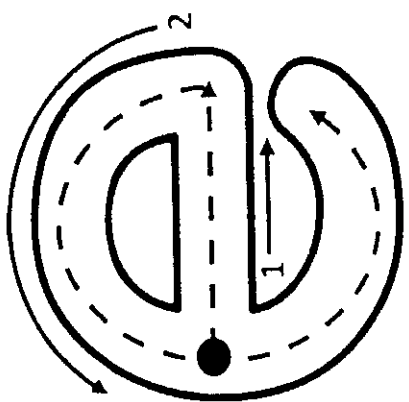

Find

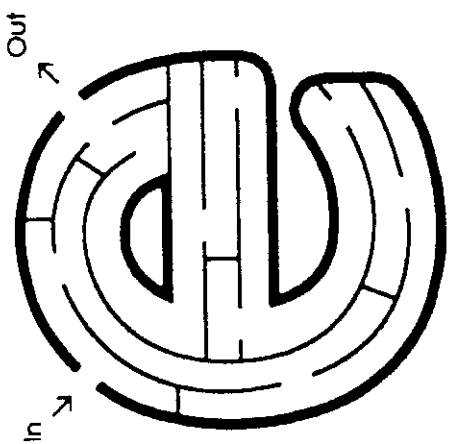

Connect

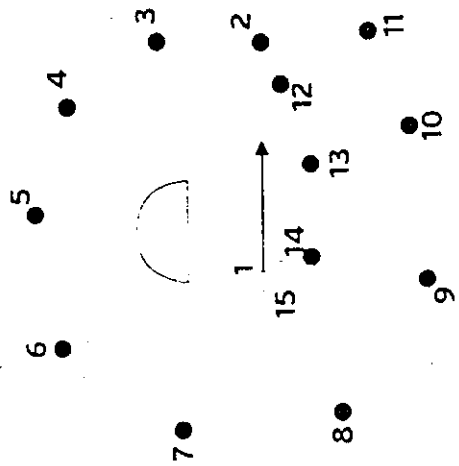

Color

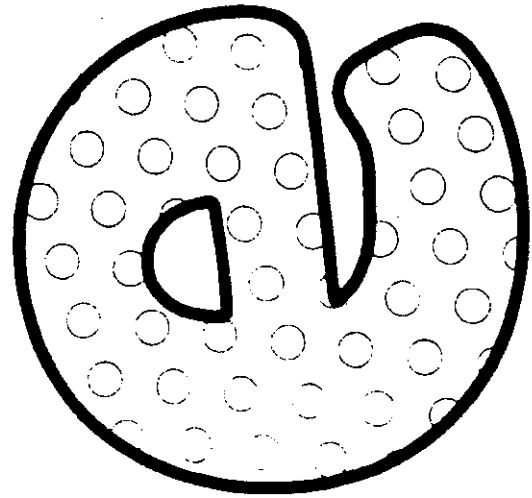

Trace

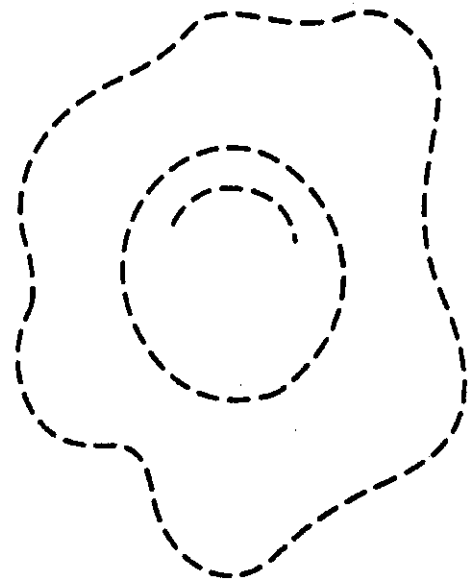

e is for  
egg

# FUN PAGE

www.thisreadingmama.com

Letter

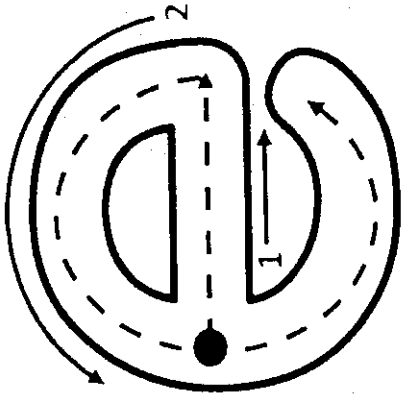

Find

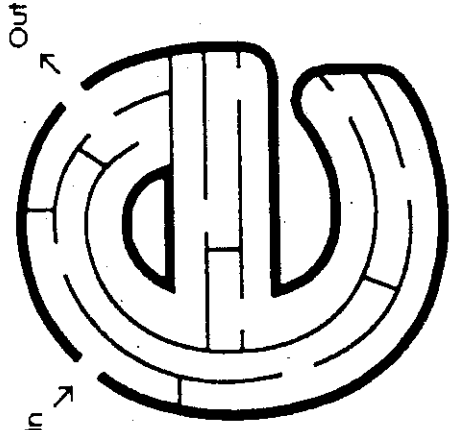

Connect

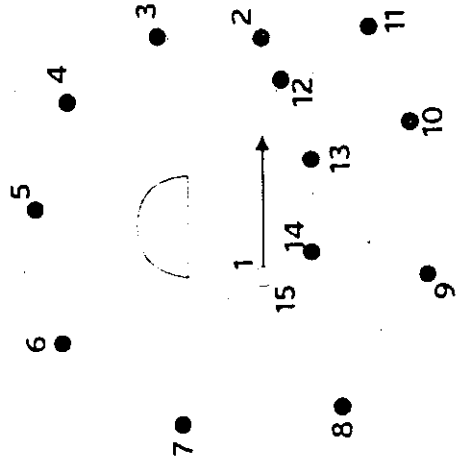

Color

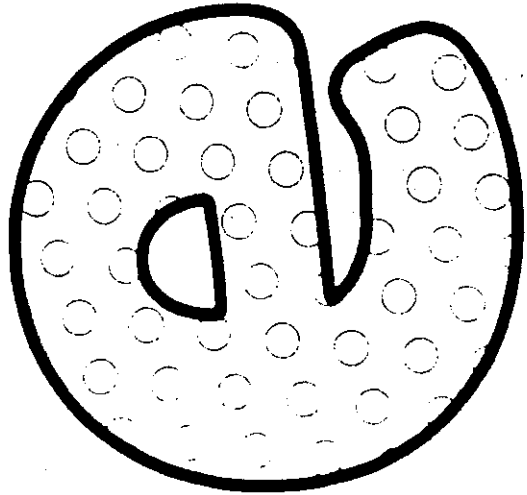

Trace

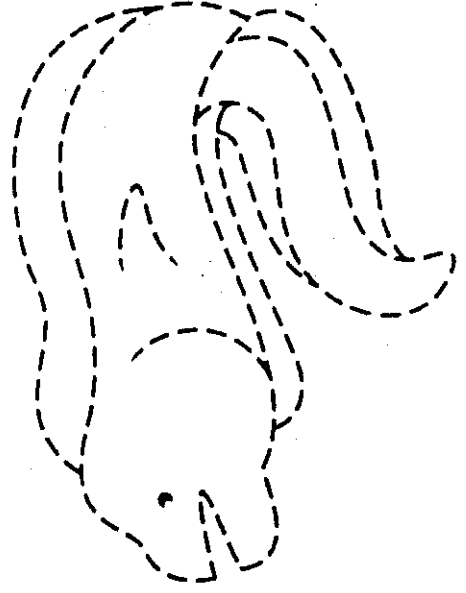

e is for  
**eel**

# FUN PAGE

www.thisreadingmama.com

Letter

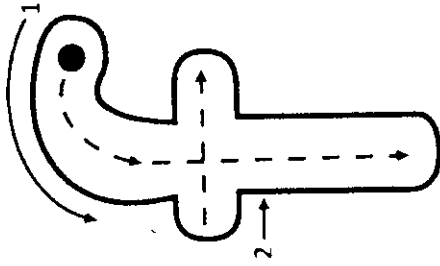

Color

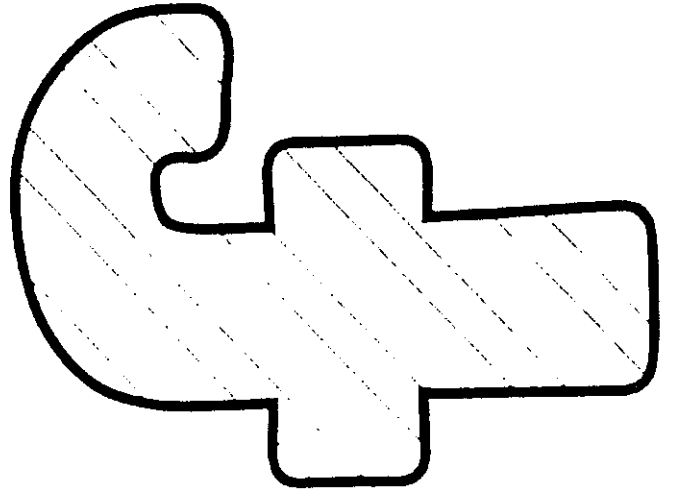

Find

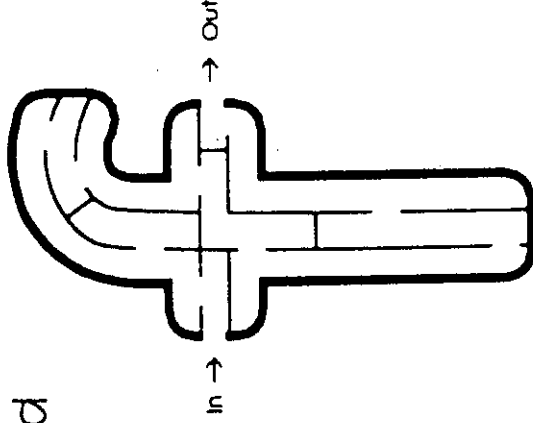

Connect

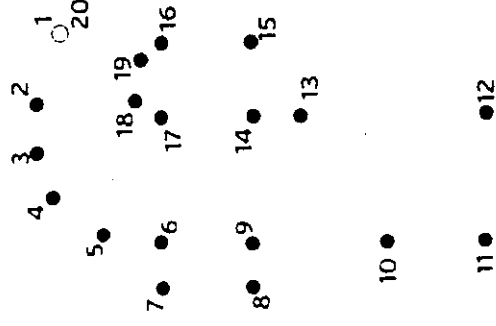

Trace

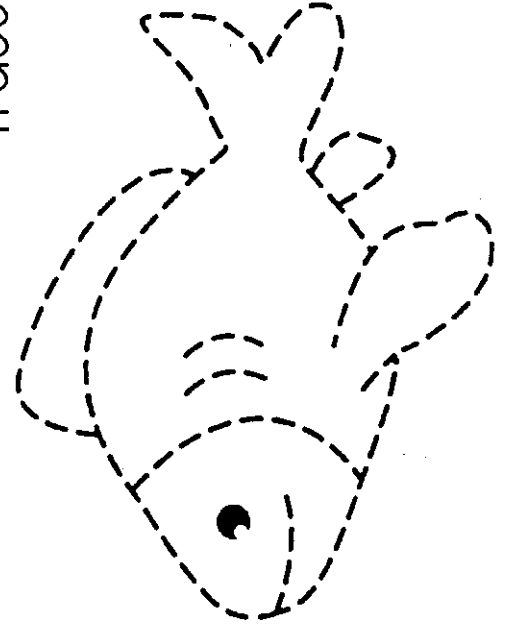

**f** is for  
**fish**

# FUN PAGE

www.thisreadingmama.com

Letter

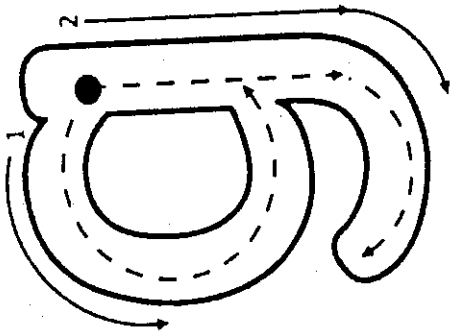

Color

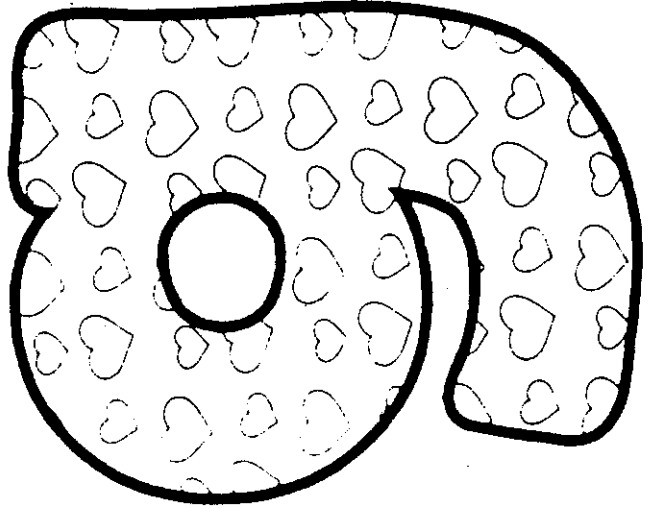

Find

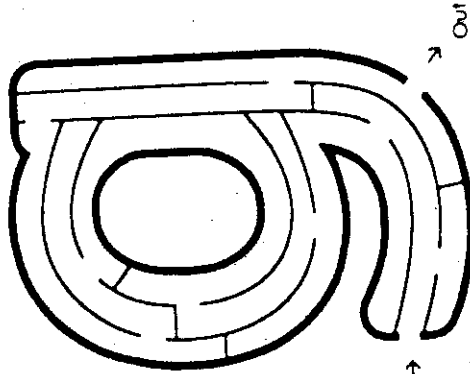

Connect

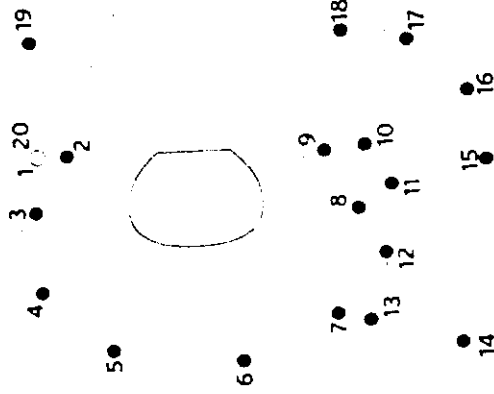

Trace

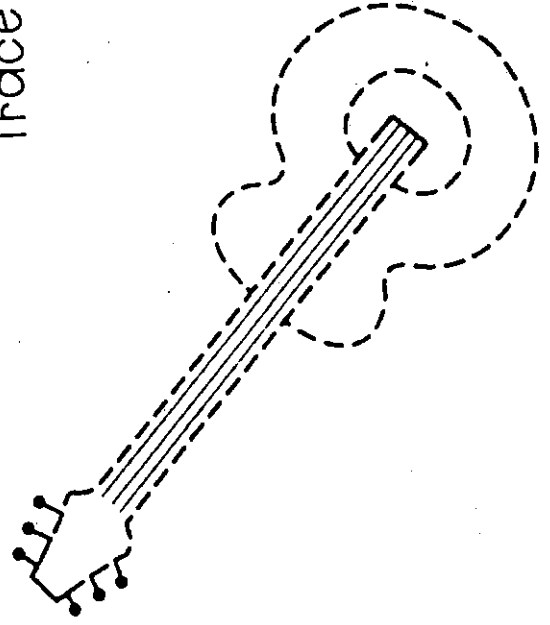

**g** is for  
**guitar**

# FUN PAGE

Letter

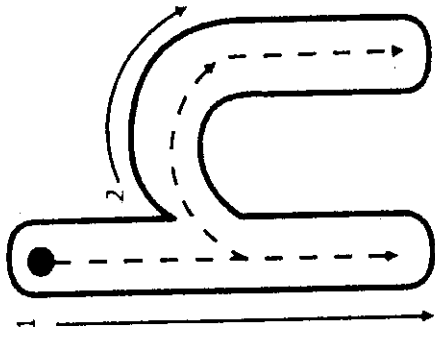

Color

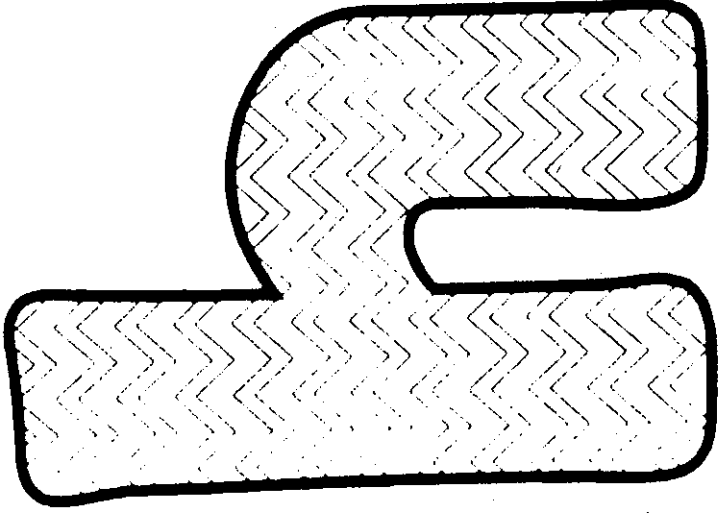

Find

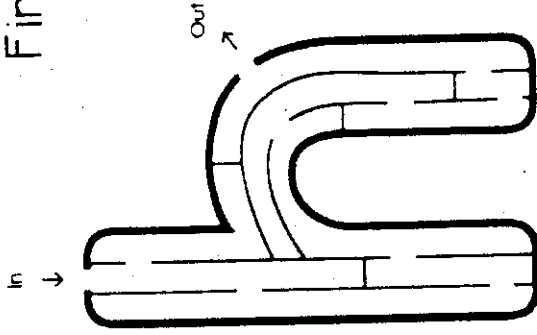

Connect

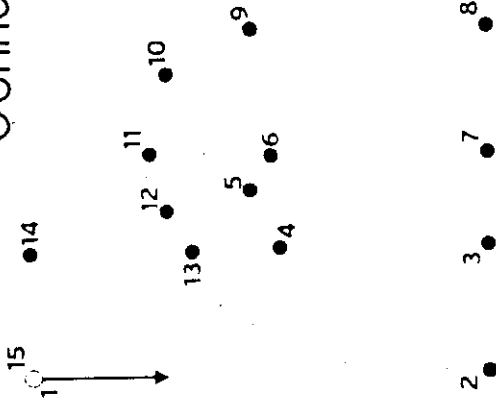

Trace

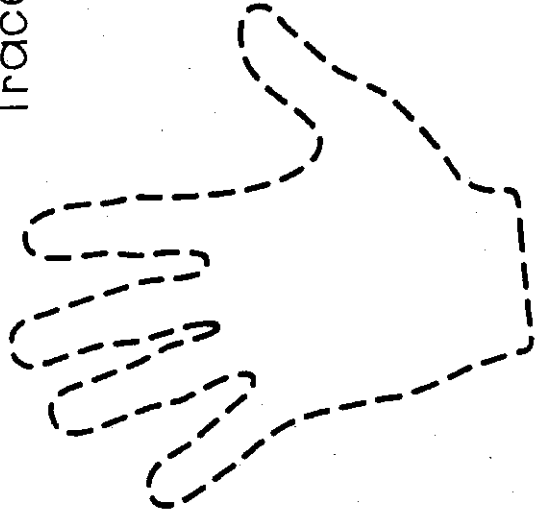

h is for  
hand

# FUN PAGE

www.thisreadingmama.com

Letter

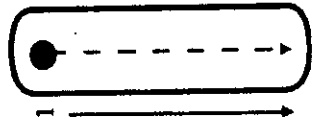
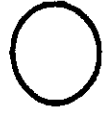

Find

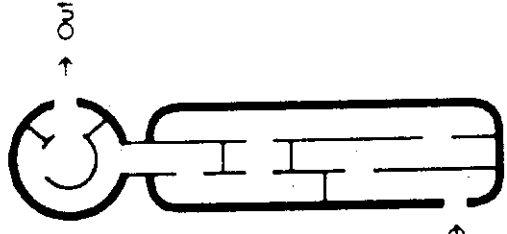

Connect

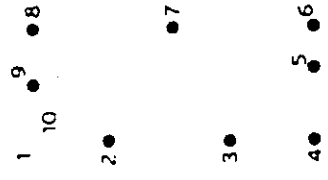
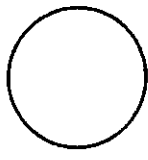

Color

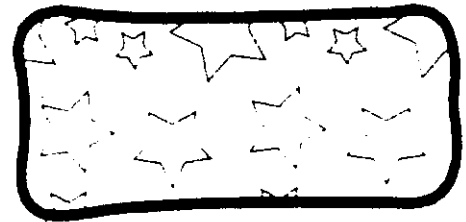
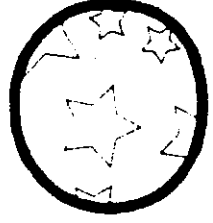

Trace

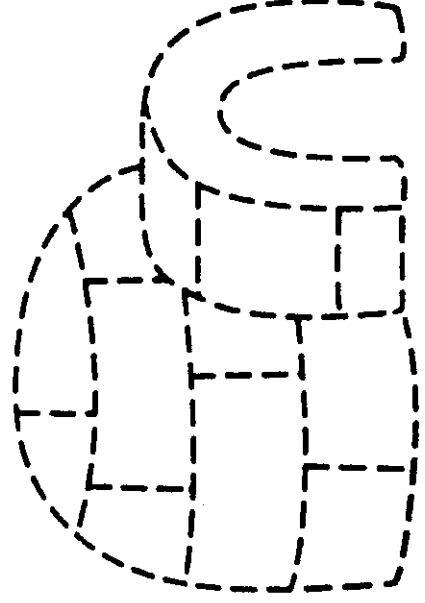

i is for  
igloo



# FUN PAGE

www.thisreadingmama.com

## Letter

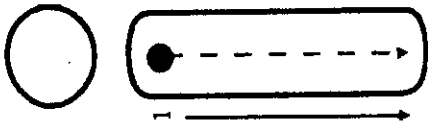

### Find

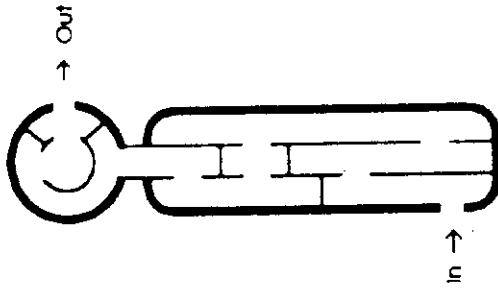

### Connect

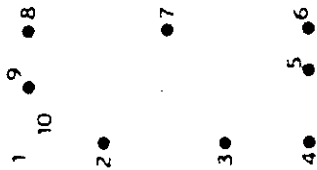
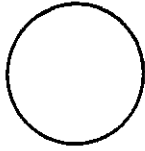

### Color

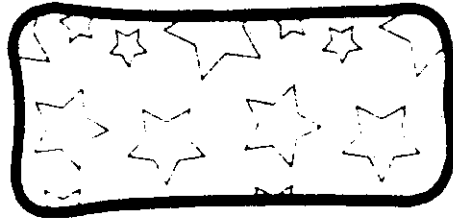
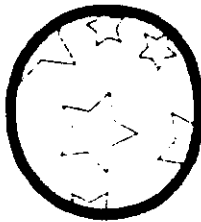

### Trace

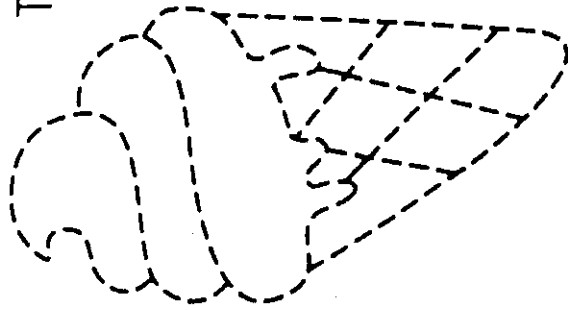

**i is for  
ice cream**

# FUN PAGE

www.thisreadingmama.com

Letter

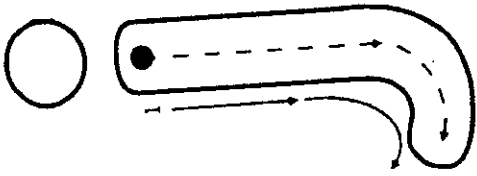

Color

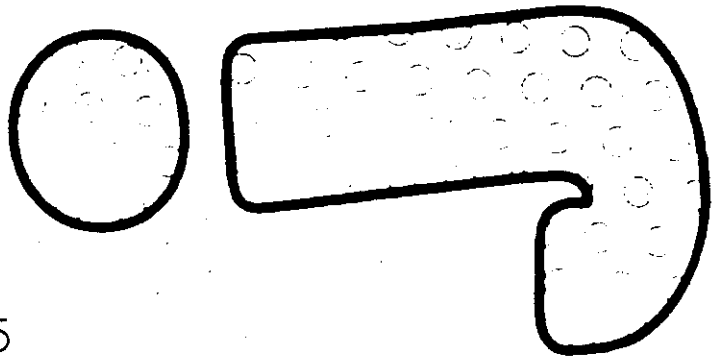

Find

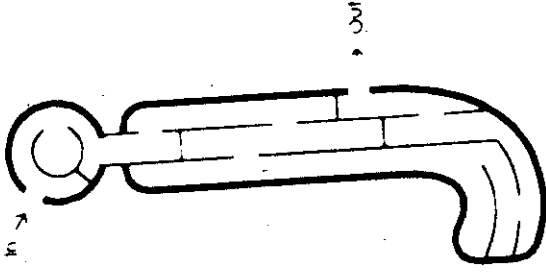

Connect

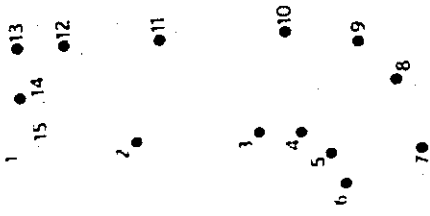
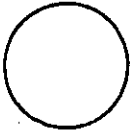

Trace

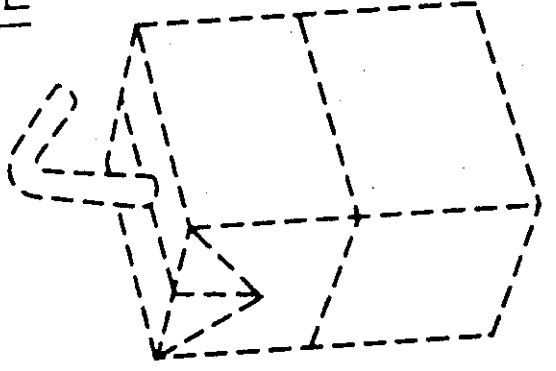

j is for  
**juice**

# FUN PAGE

www.thisreadingmama.com

Letter

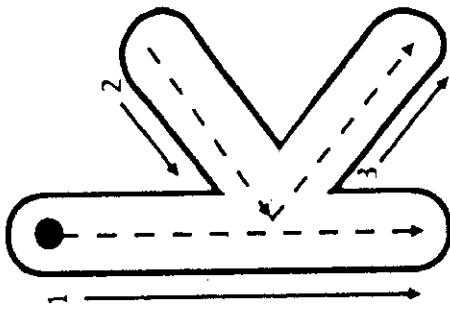

Color

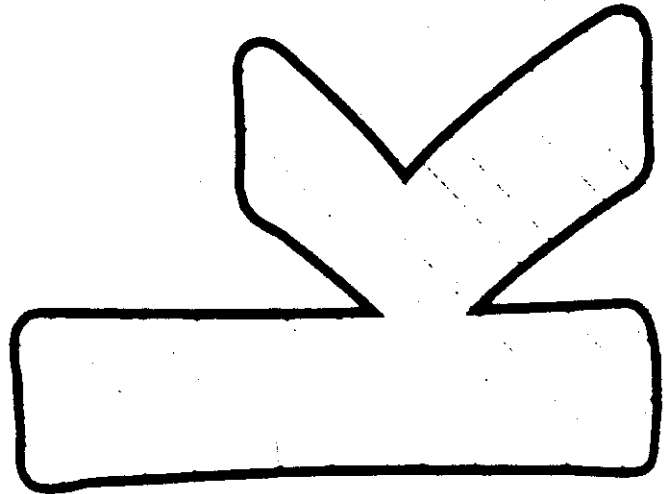

Find

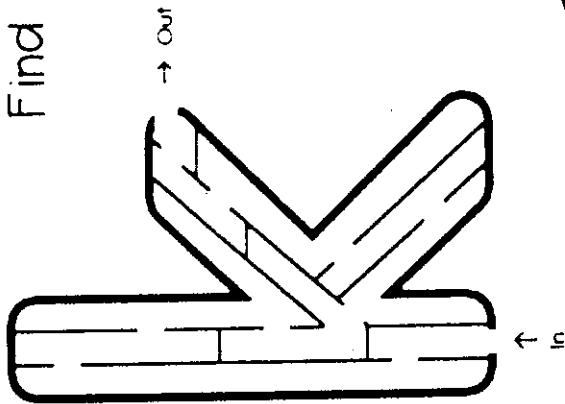

Connect

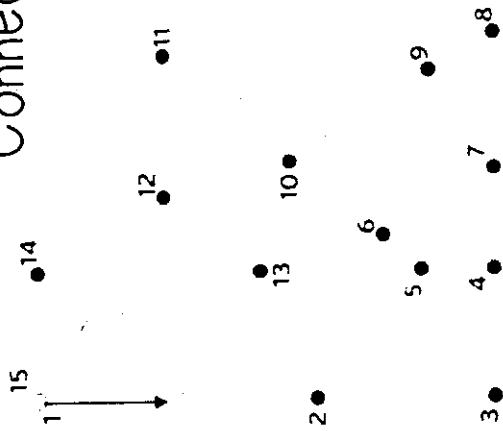

Trace

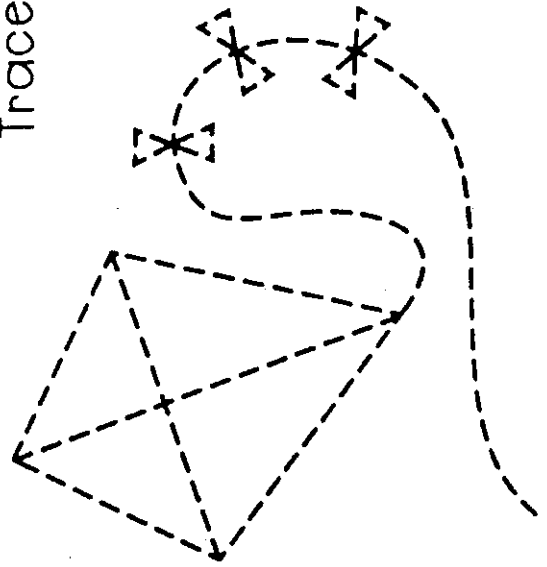

k is for  
**kite**

# FUN PAGE

www.thisreadingmama.com

Letter

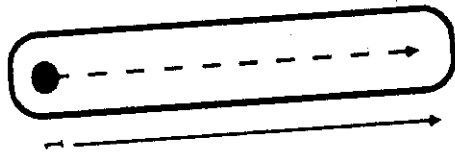

Color

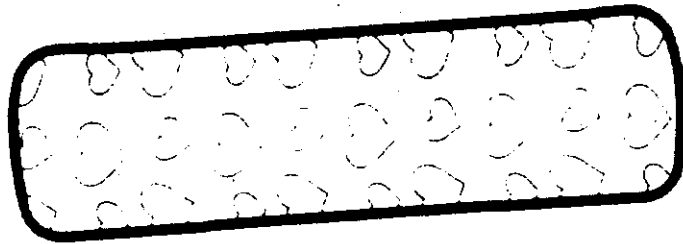

Find

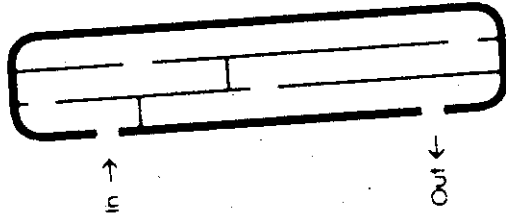

Connect

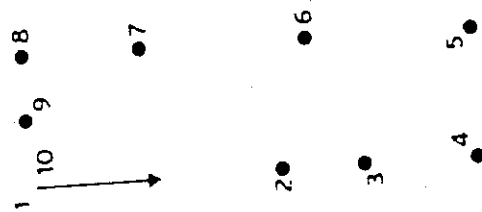

Trace

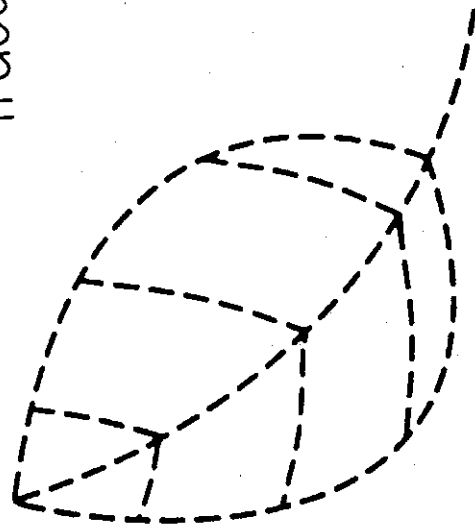

l is for  
**leaf**

# FUN PAGE

Letter

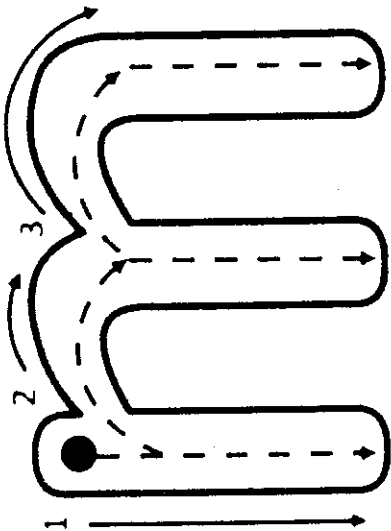

Connect

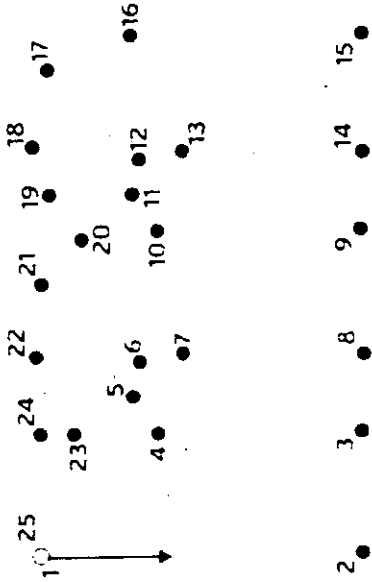

Find

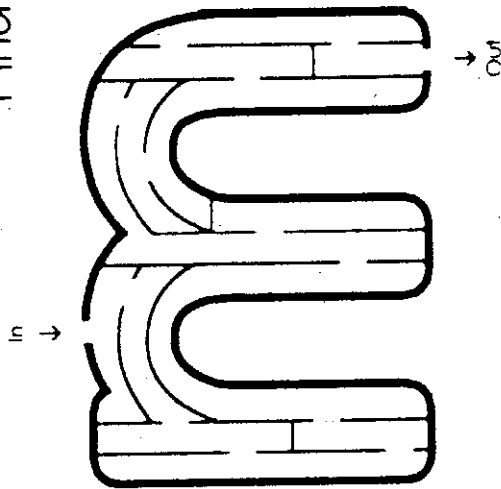

Color

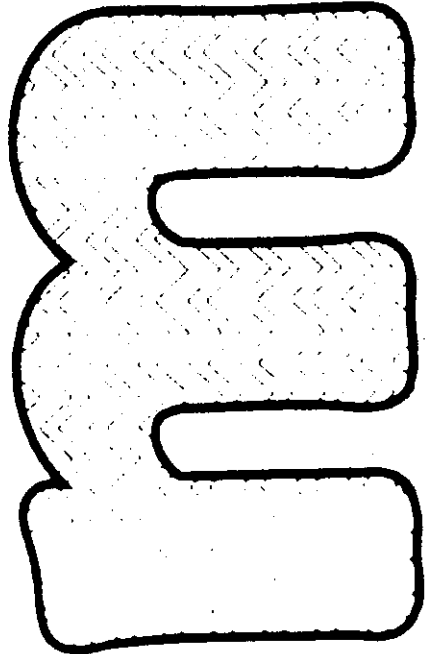

Trace

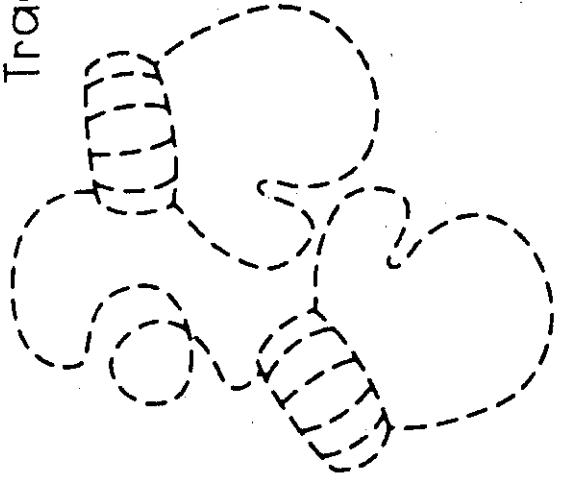

m is for  
**mitten**s

# FUN PAGE

www.thisreadingmama.com

Letter

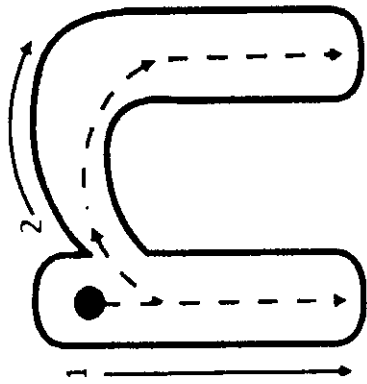

Color

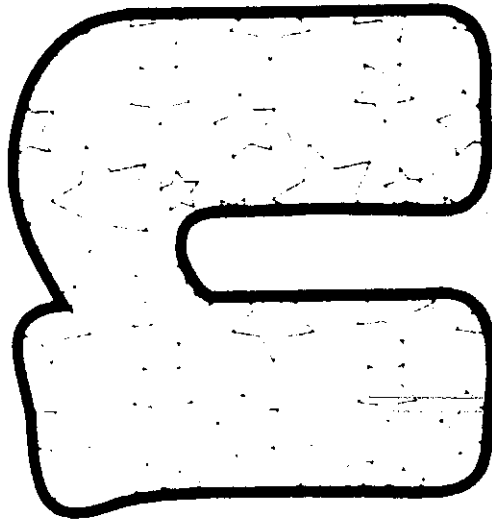

Connect

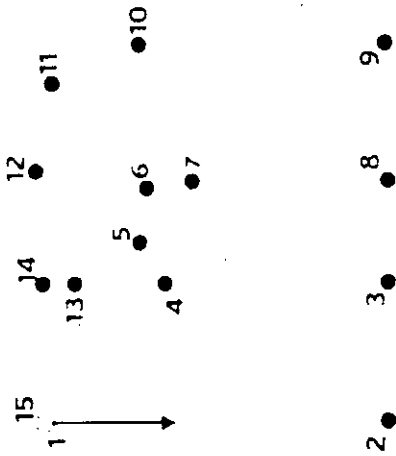

Find

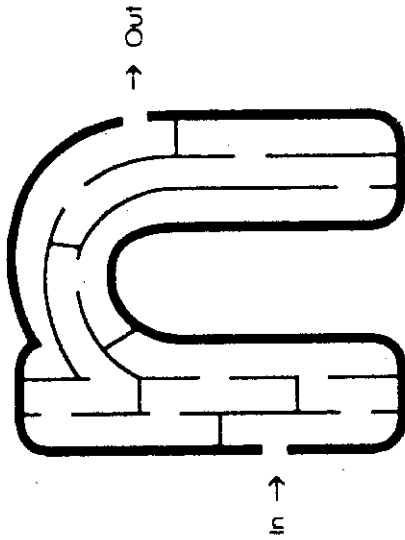

Trace

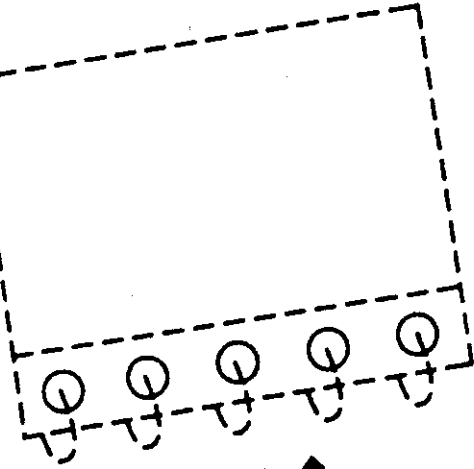

n is for  
notebook

# FUN PAGE

www.thisreadingmama.com

Letter

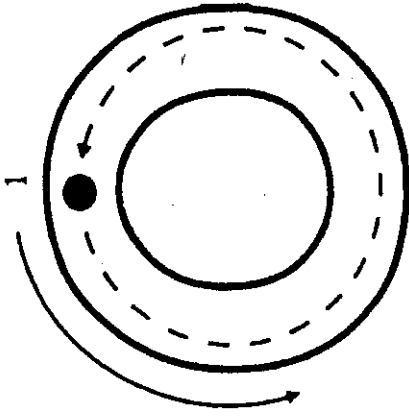

Find

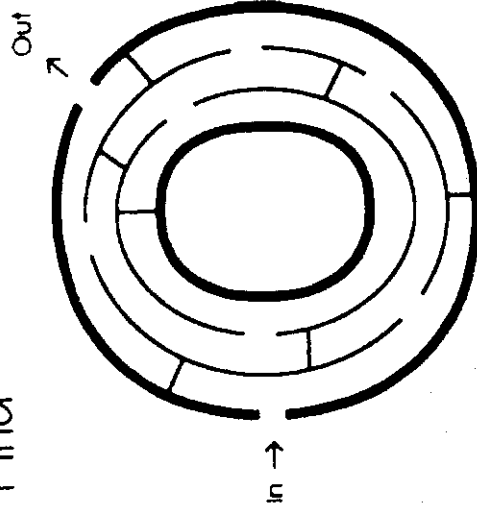

Connect

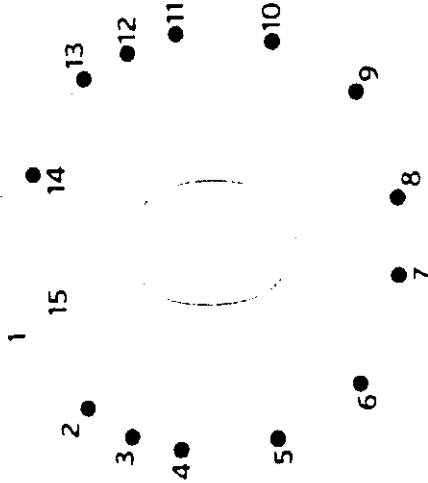

Color

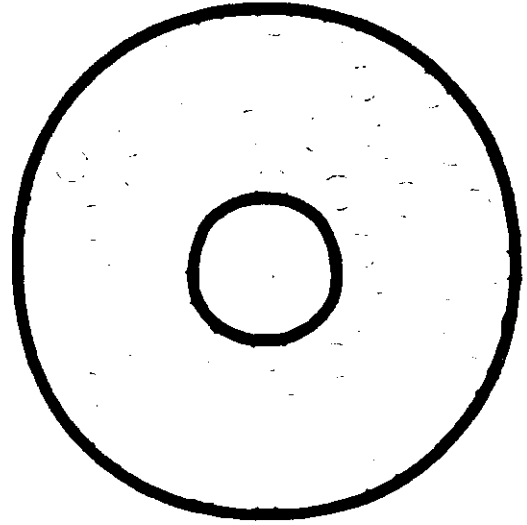

Trace

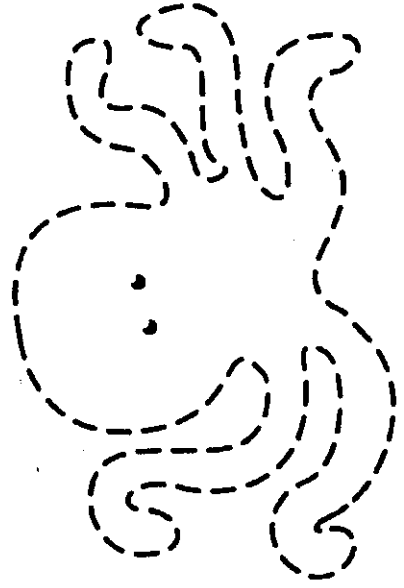

O is for  
**octopus**

# FUN PAGE

www.thisreadingmama.com

Letter

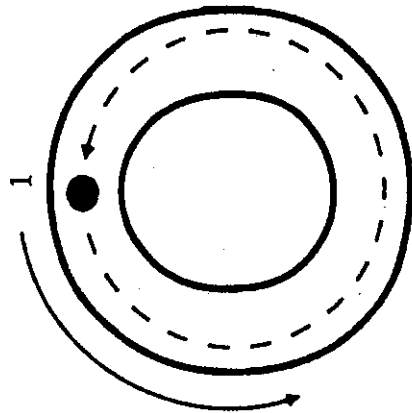

Find

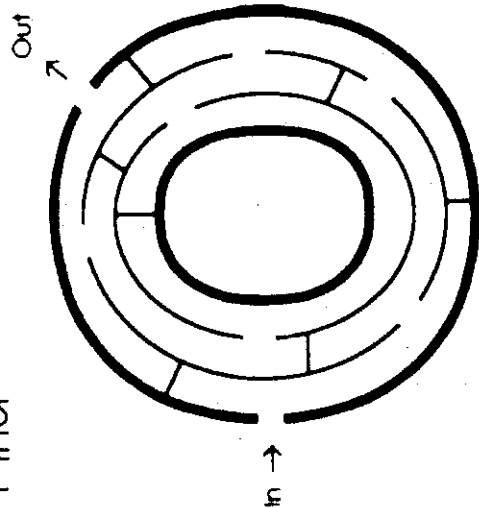

Connect

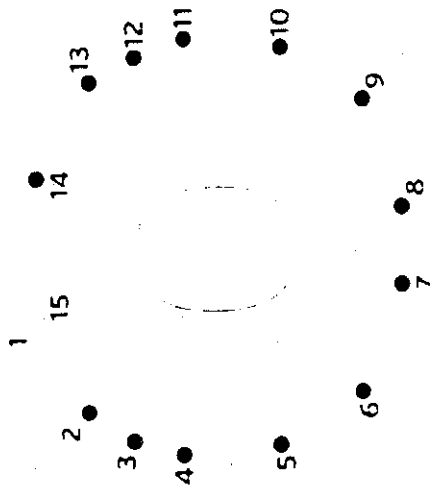

Color

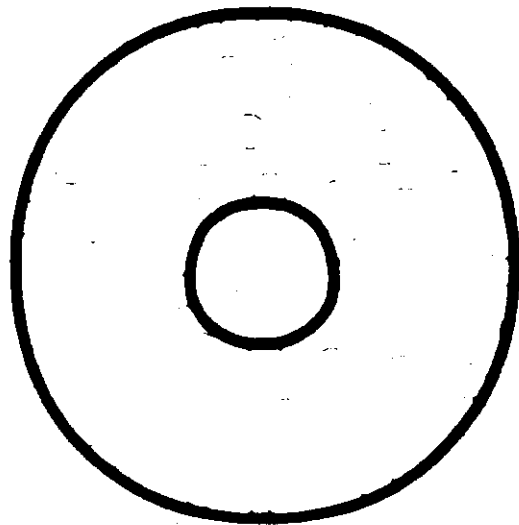

o is for  
**overalls**

Trace

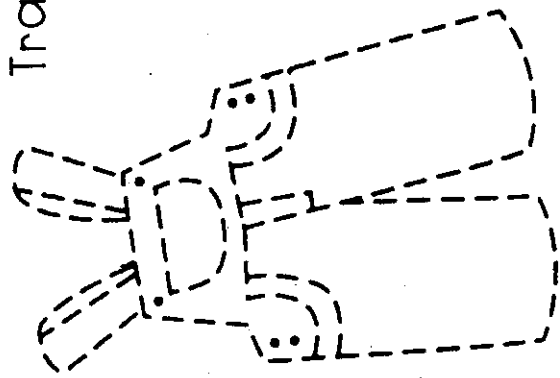



# FUN PAGE

www.thisreadingmama.com

Letter

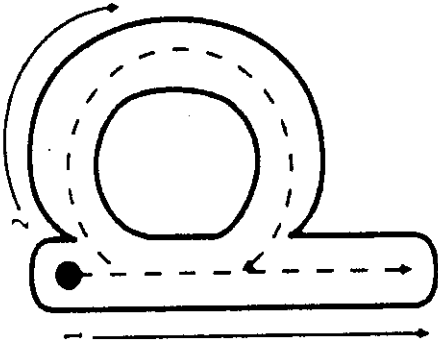

Color

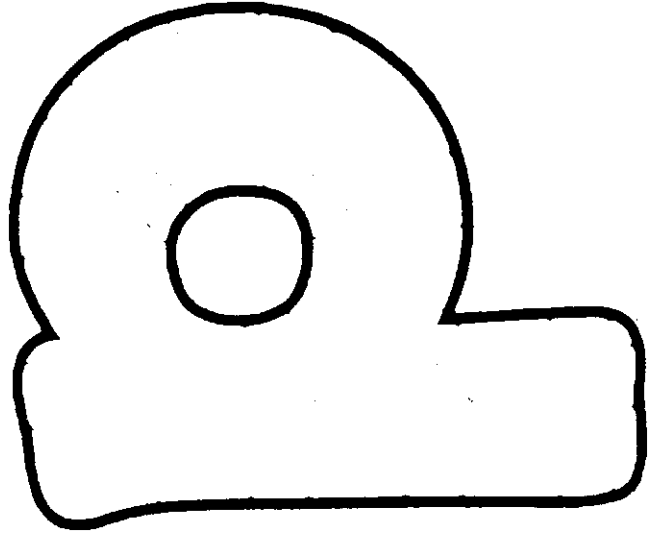

Connect

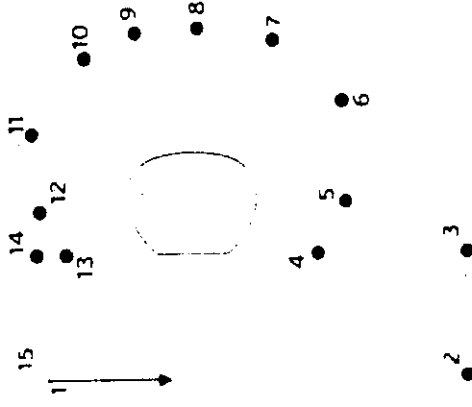

Trace

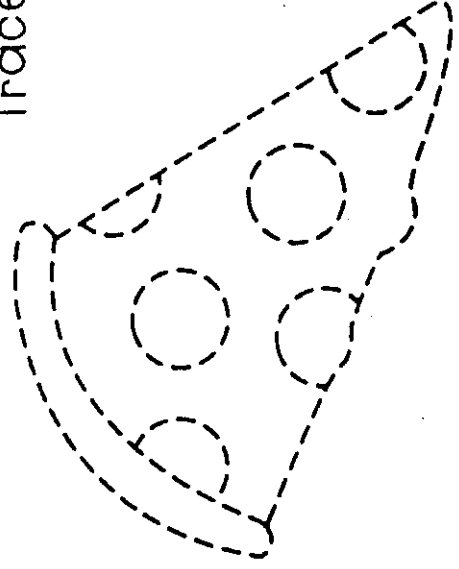

p is for  
**pizza**

# FUN PAGE

www.thisreadingmama.com

Letter

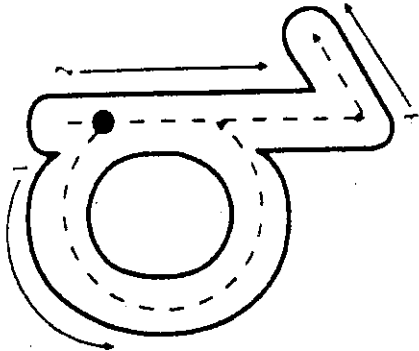

Find

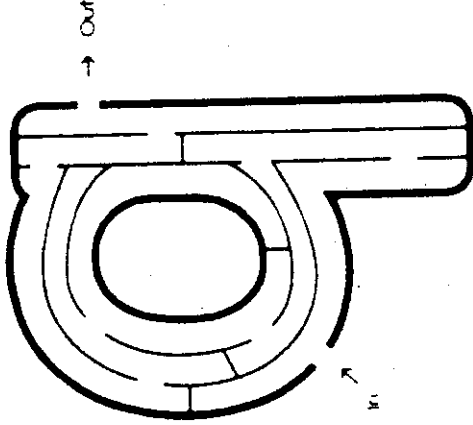

Connect

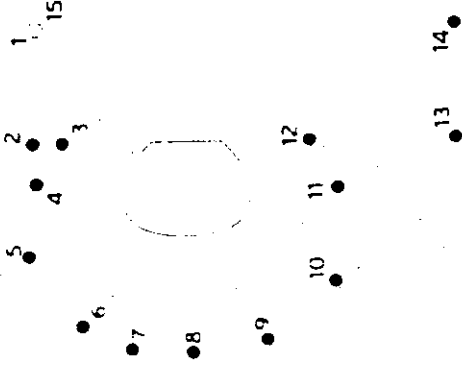

Color

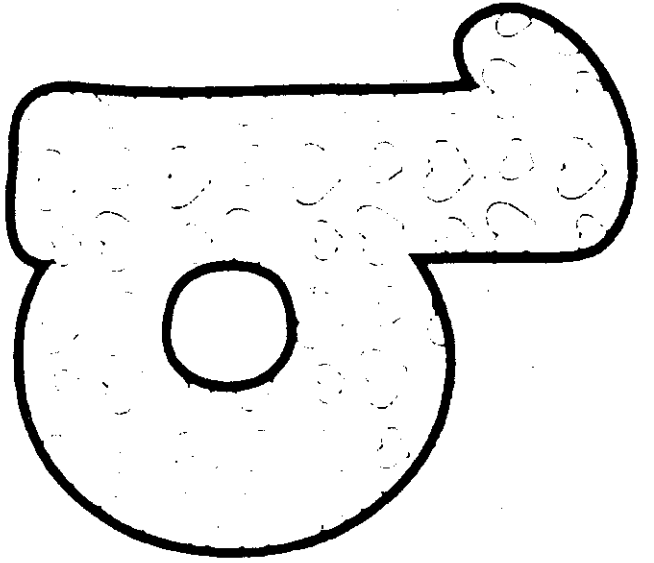

Trace

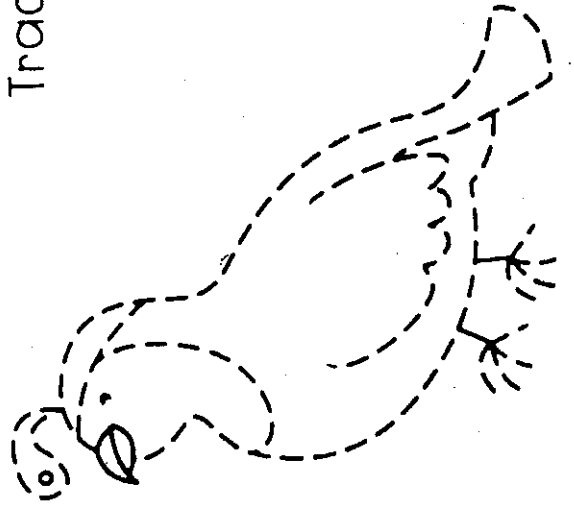

q is for  
**quail**

# FUN PAGE

Letter

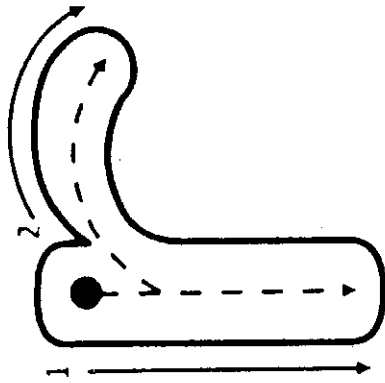

Find

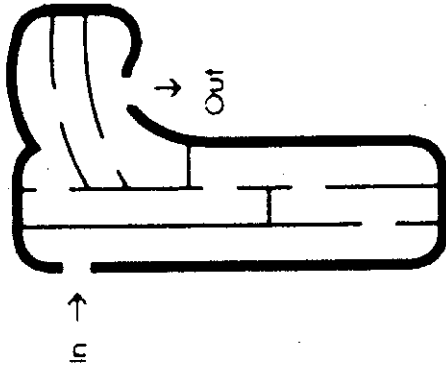

Connect

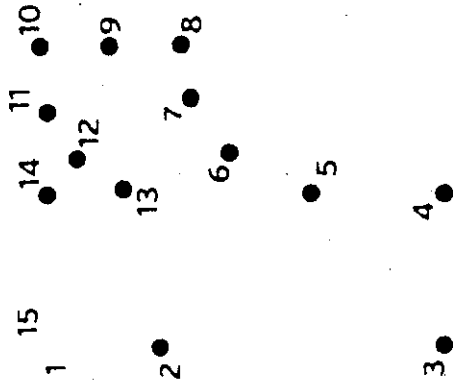

Color

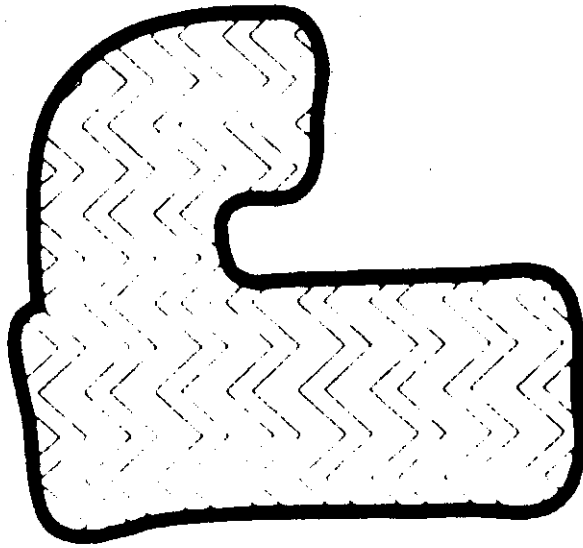

Trace

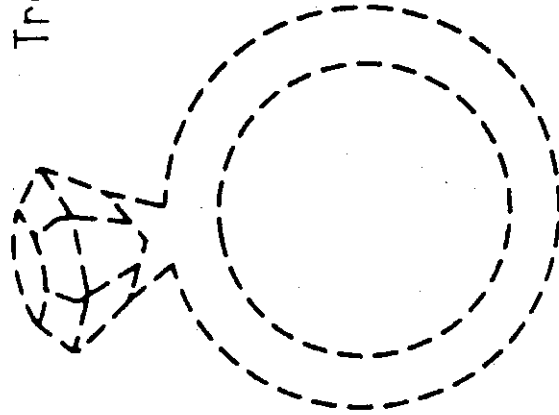

r is for  
ring

# FUN PAGE

www.thisreadingmama.com

Letter

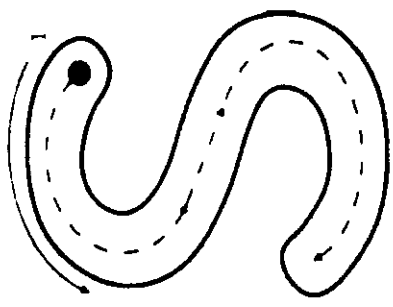

Find In

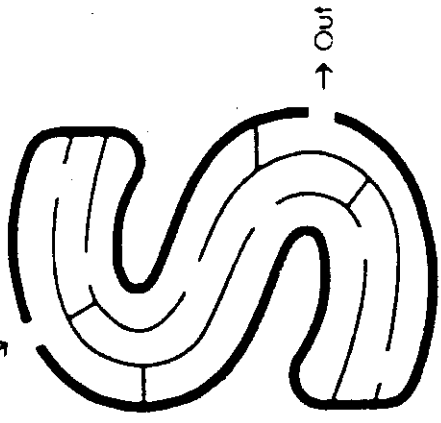

Connect

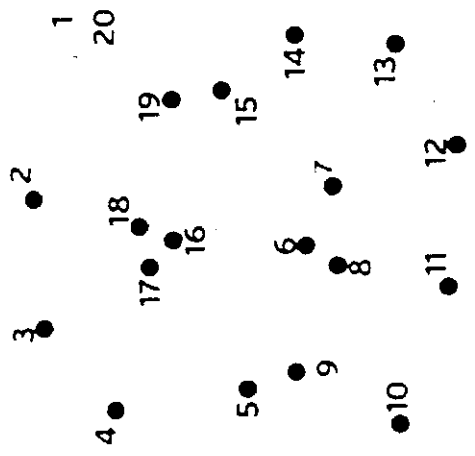

Trace

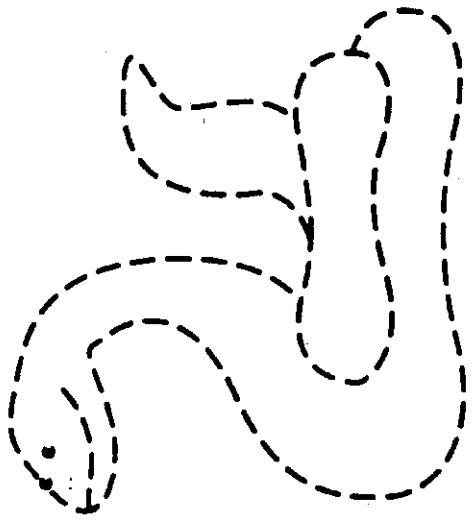

s is for  
snake

Color

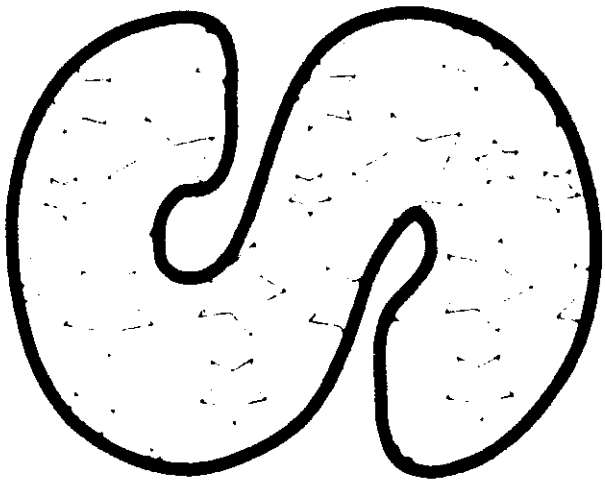

# FUN PAGE

www.funreadingmama.com

Letter

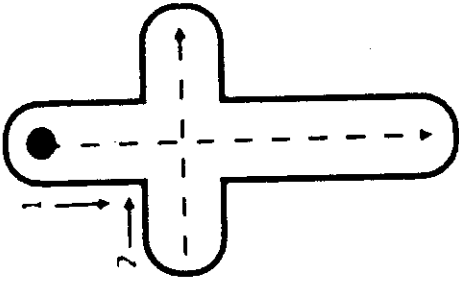

Find

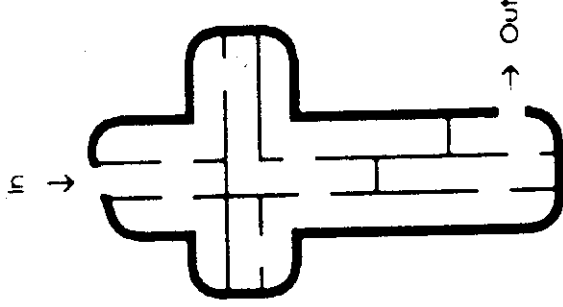

Connect

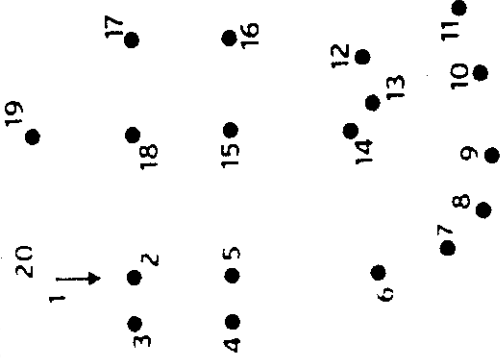

Color

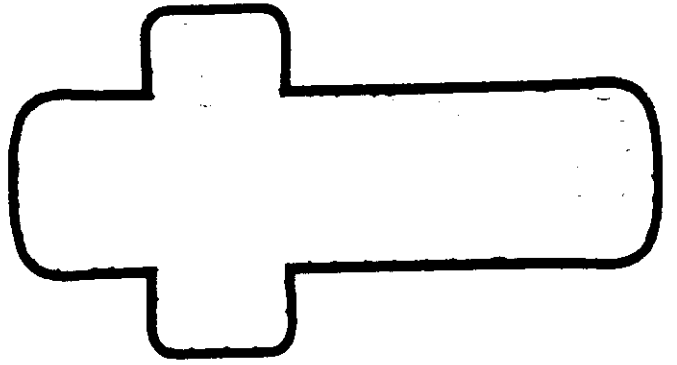

Trace

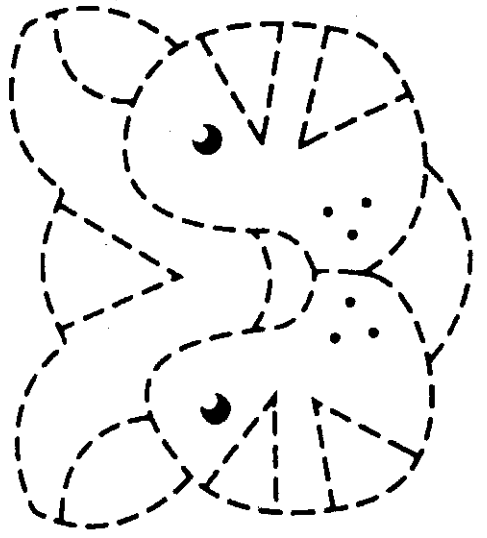

t is for  
**tiger**

# FUN PAGE

www.thisreadingmama.com

Letter

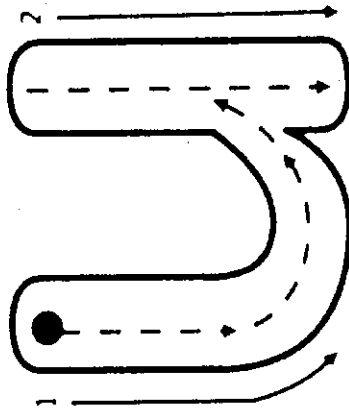

Find

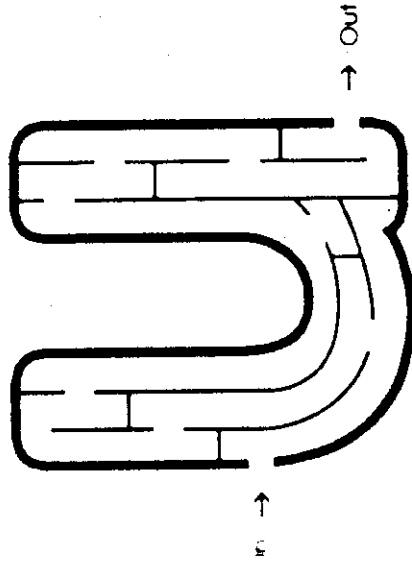

Connect

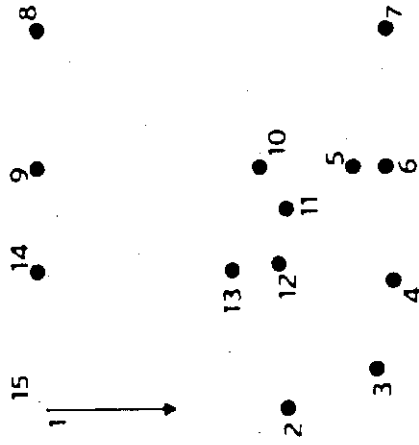

Color

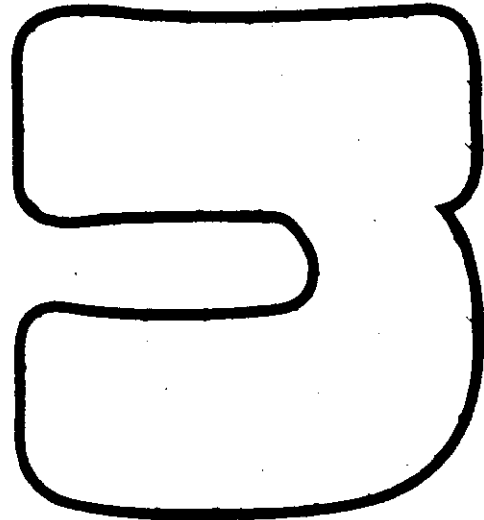

Trace

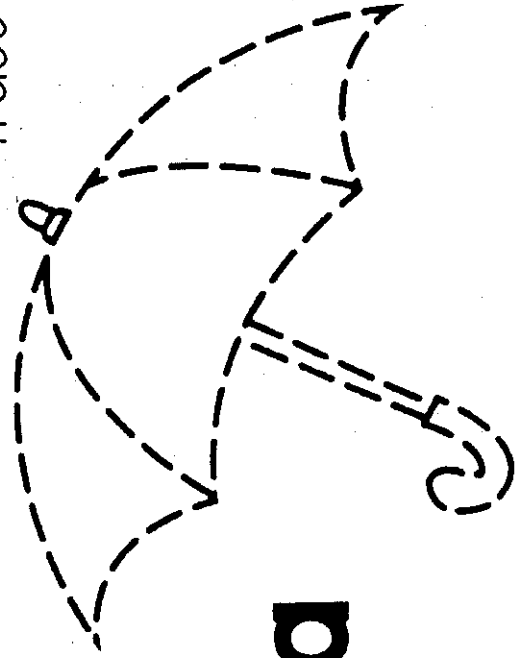

u is for  
umbrella

# FUN PAGE

www.thisreadingmama.com

Letter

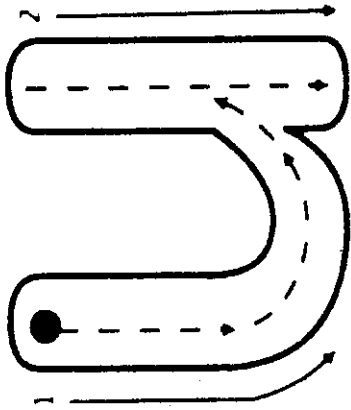

Color

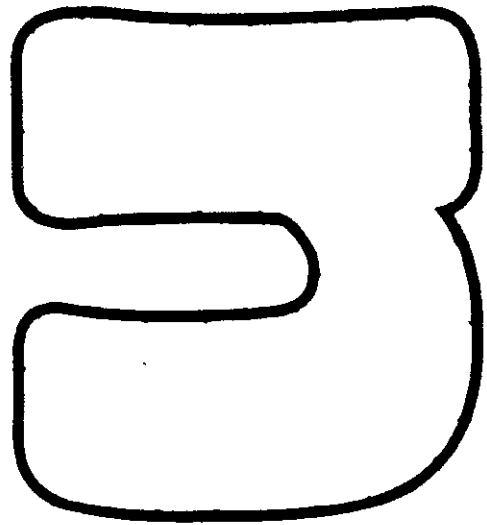

Connect

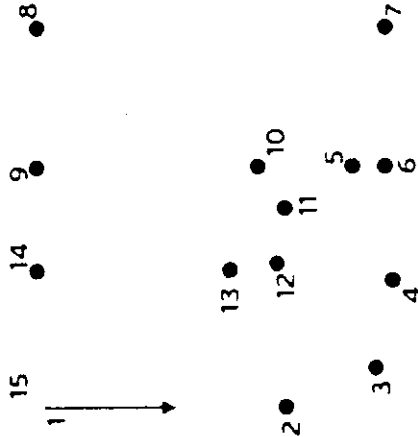

Find

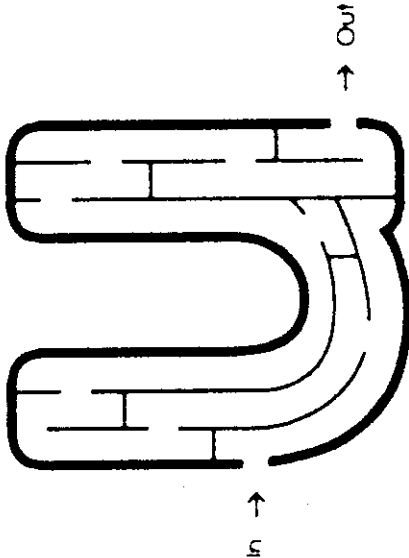

Trace

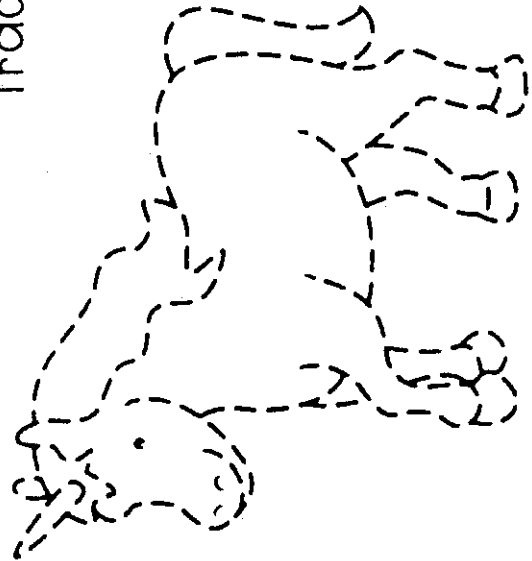

u is for unicorn

# FUN PAGE

www.thisreadingmama.com

Letter

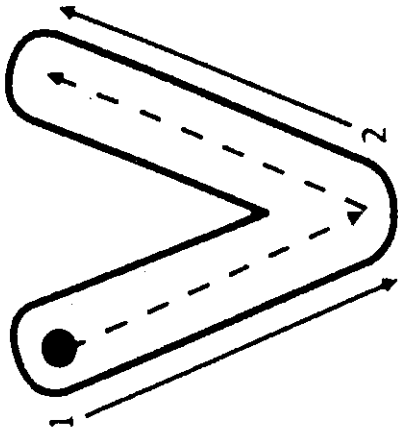

Find In



Out

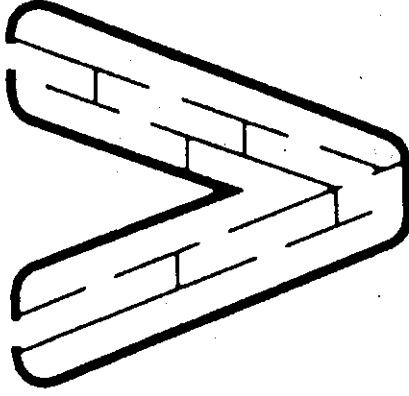

Connect

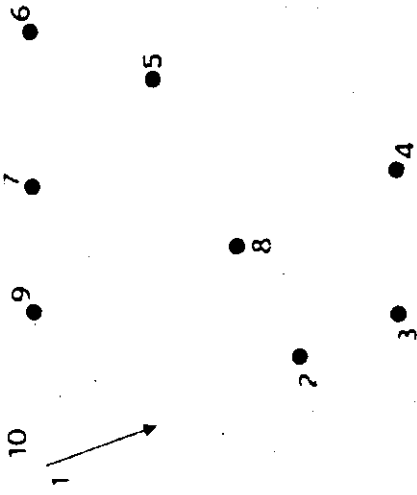

Trace

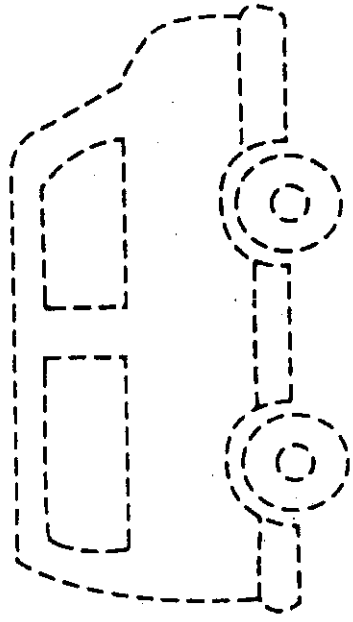

v is for

van

Color

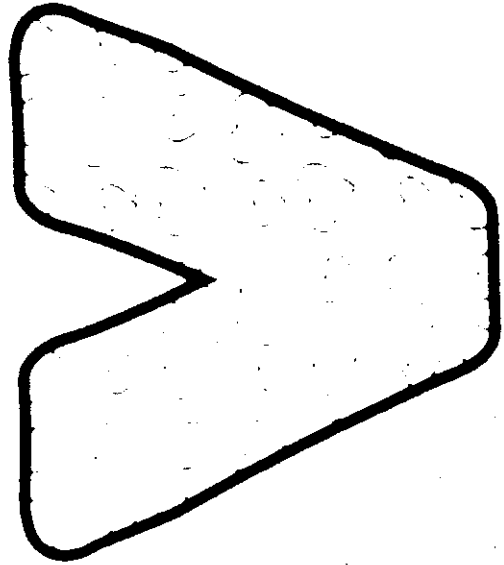



# FUN PAGE

Letter

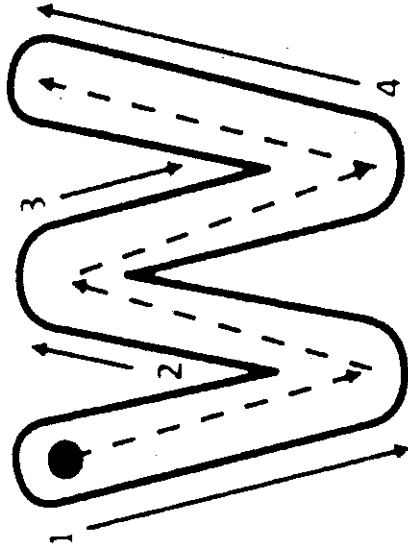

Color

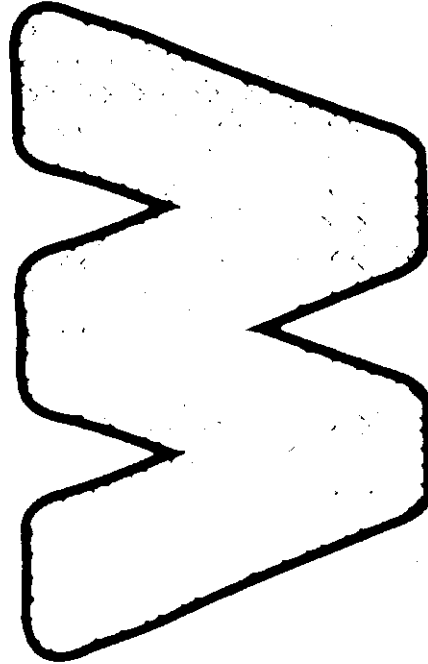

Find

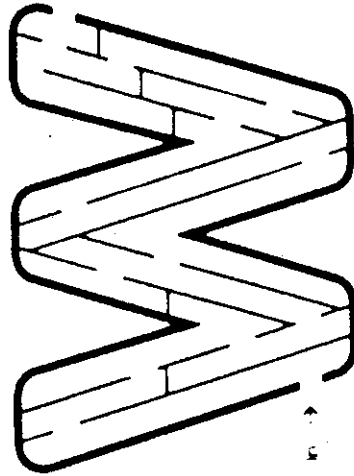

Connect

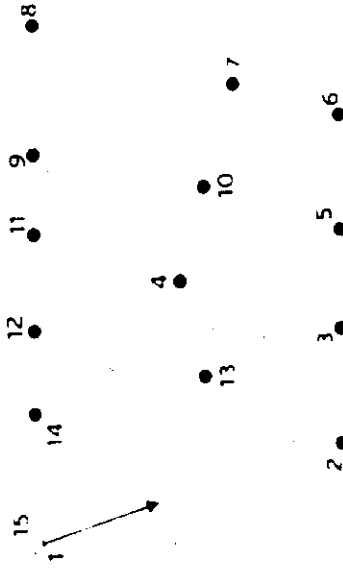

Trace

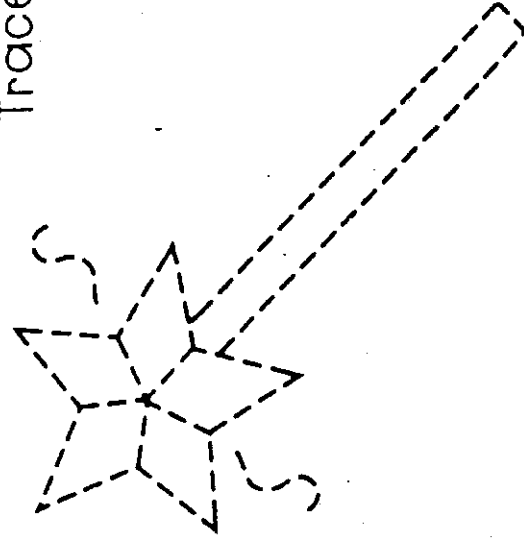

w is for  
**wand**

# FUN PAGE

www.thisreadingmama.com

Letter

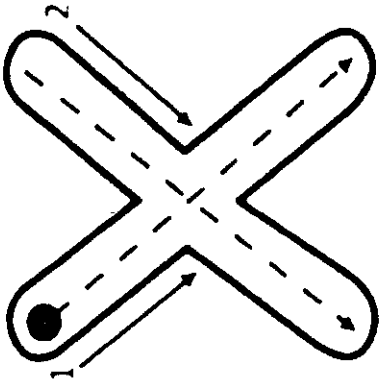

Find

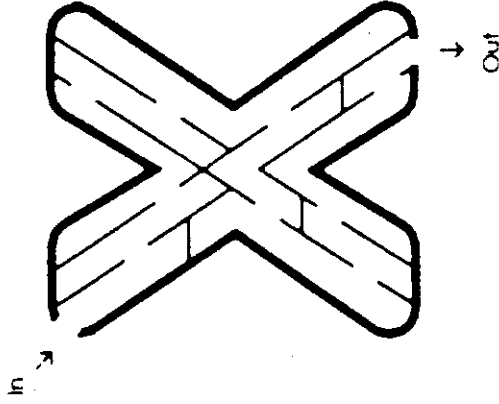

Connect

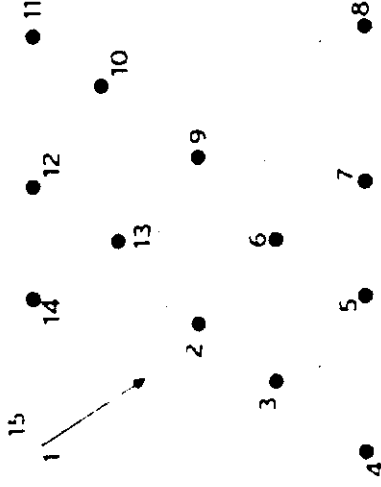

Color

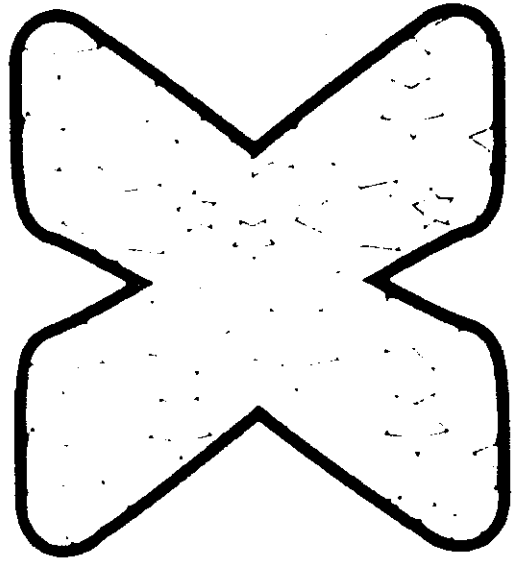

Trace

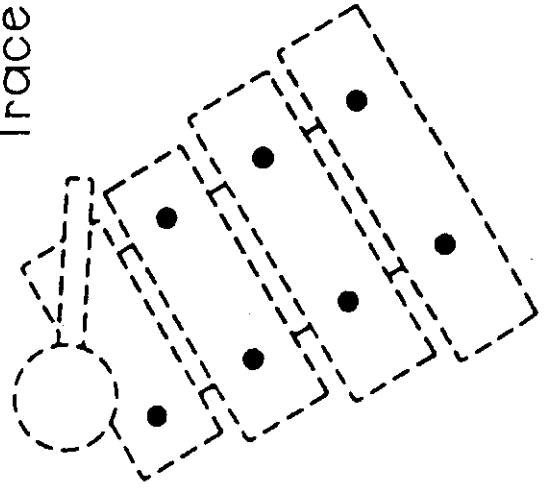

x is for  
**xylophone**

# FUN PAGE

www.thisreadingmama.com

Letter

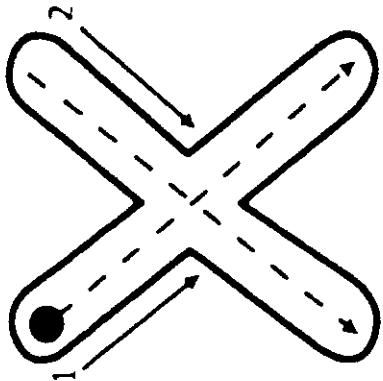

Find

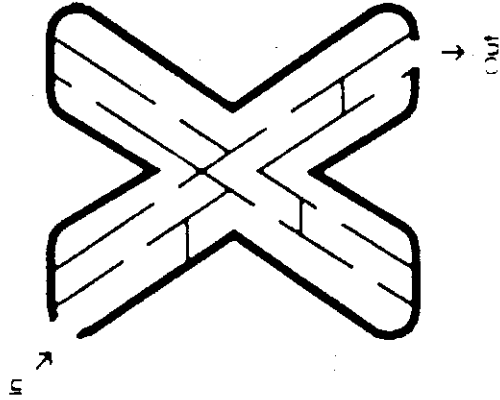

Connect

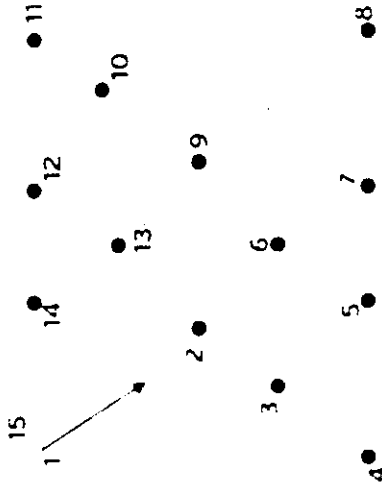

Color

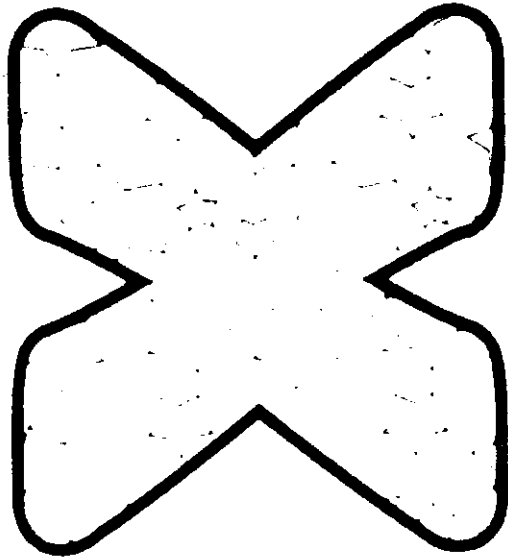

Trace

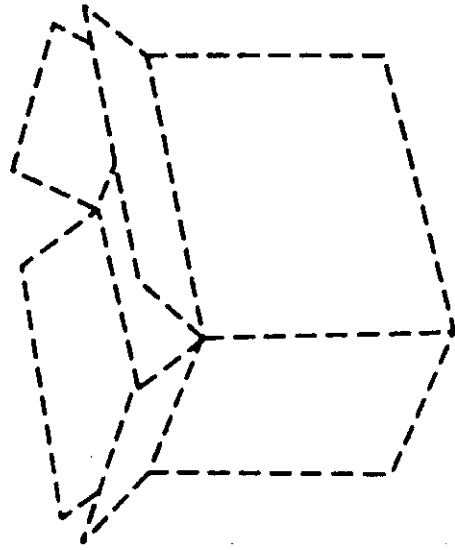

**x** is for  
**box**

# FUN PAGE

www.thisreadingmama.com

Letter

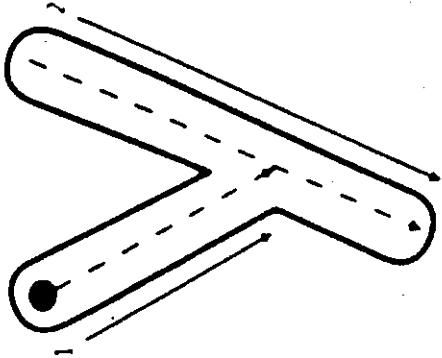

Find

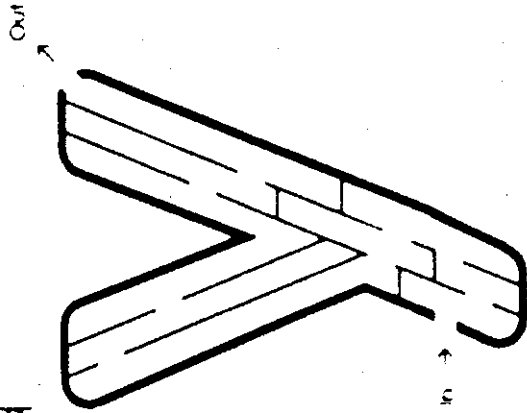

Connect

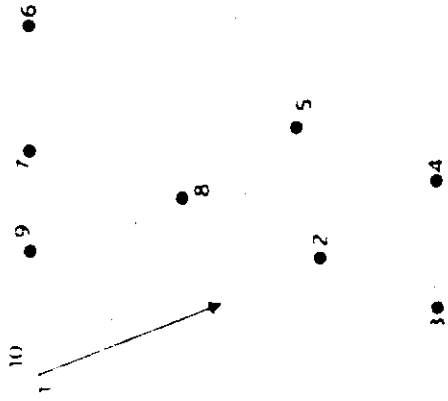

Color

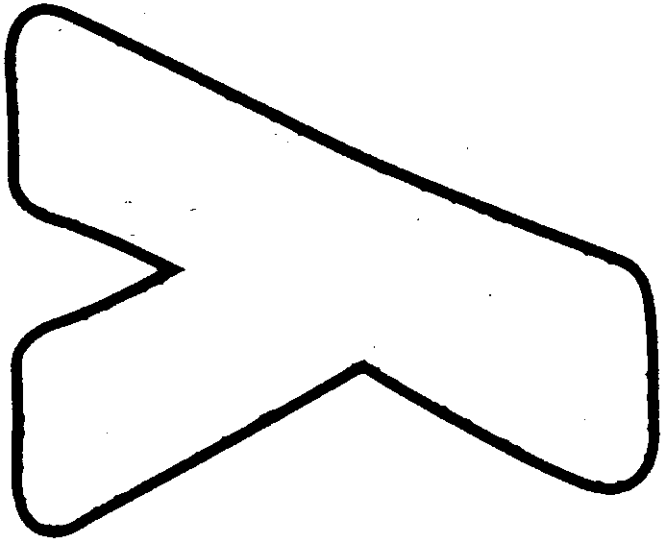

Trace

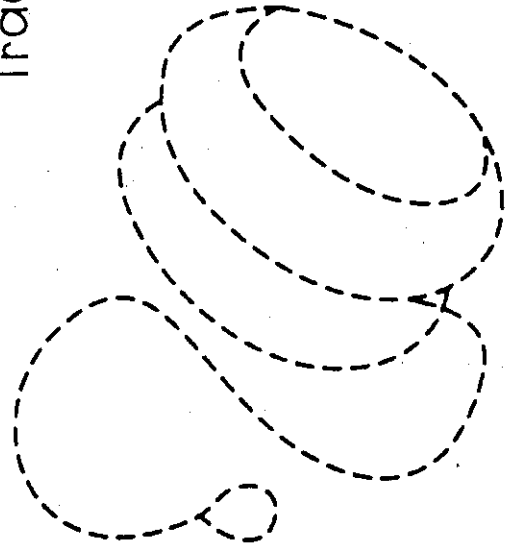

Y is for  
YO-YO

# FUN PAGE

www.thisreadingmama.com

Letter

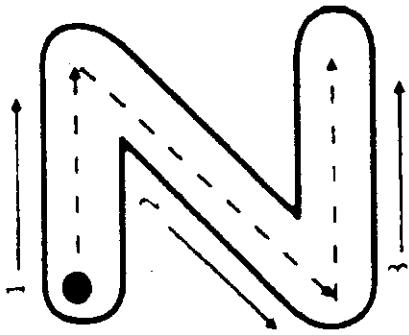

Find

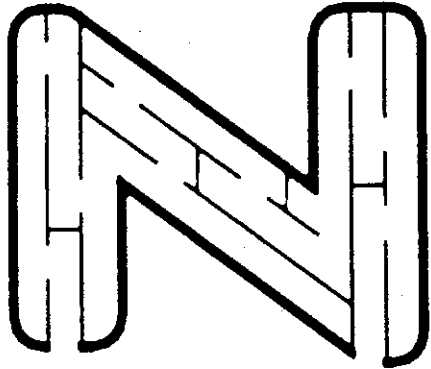

Connect

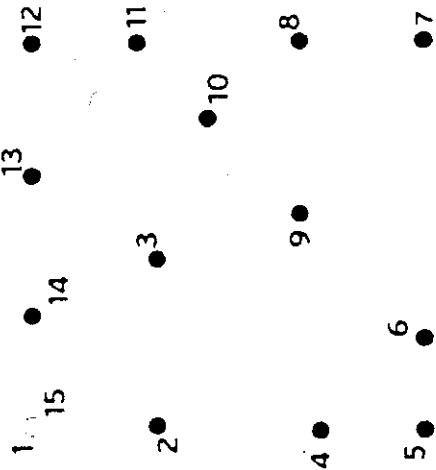

Color

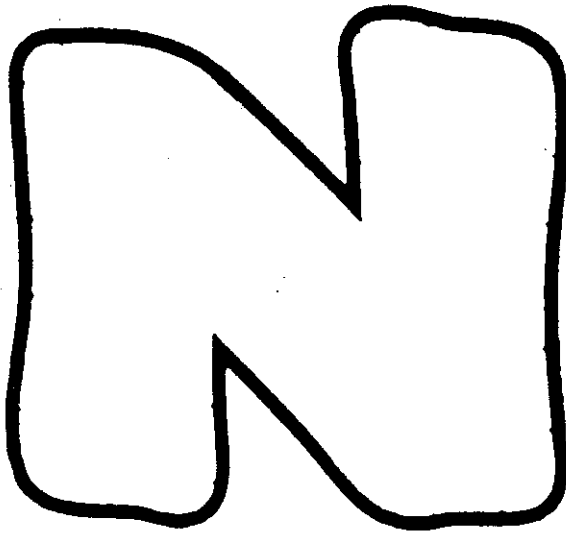

Trace

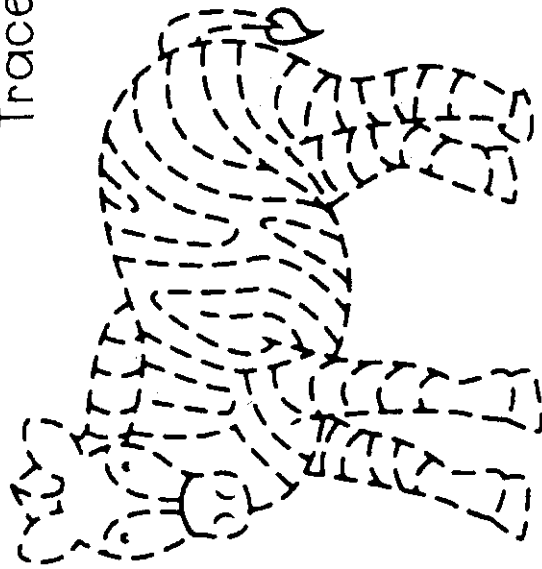

Z is for  
**zebra**

Letter Tracing

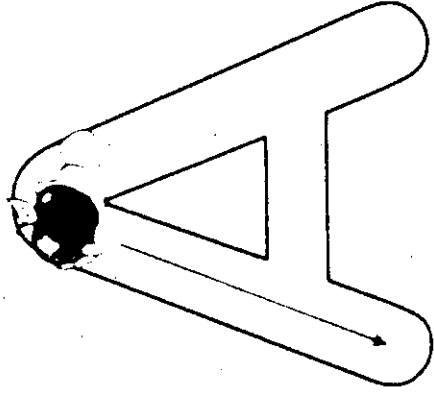
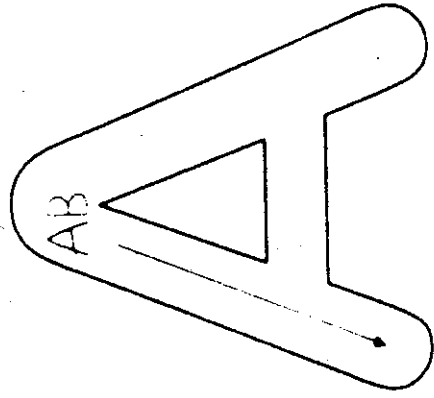
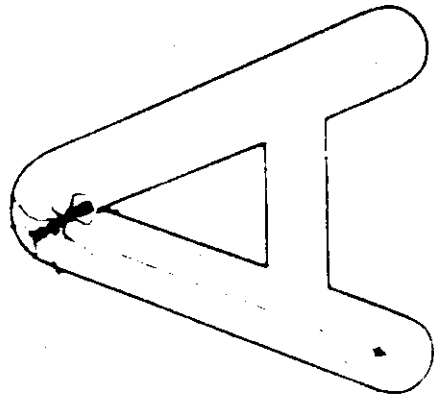
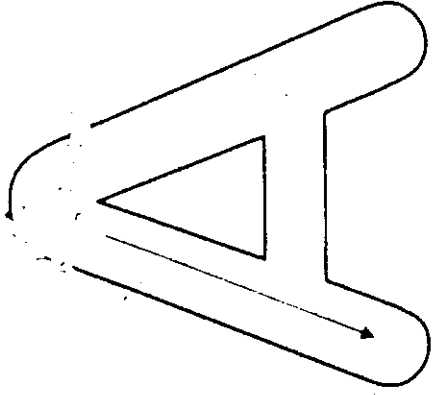
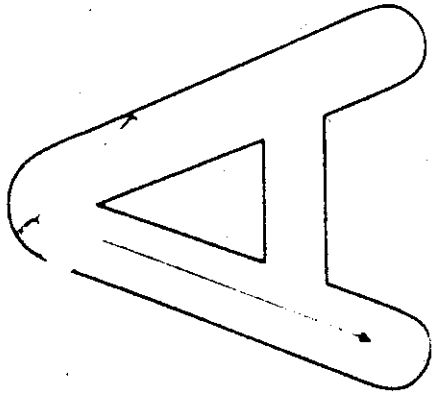
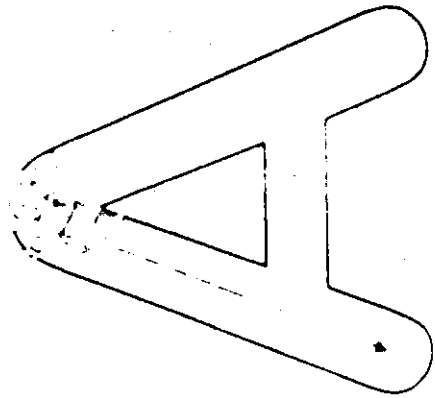

# Letter Tracing

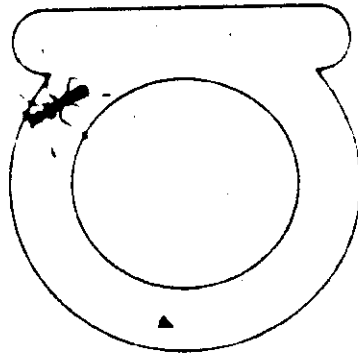
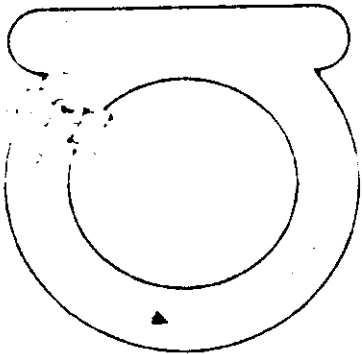
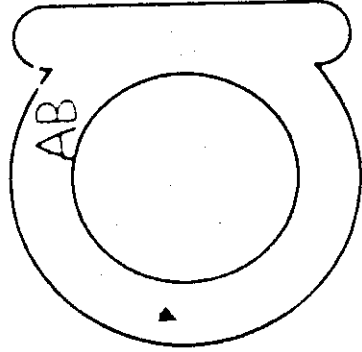
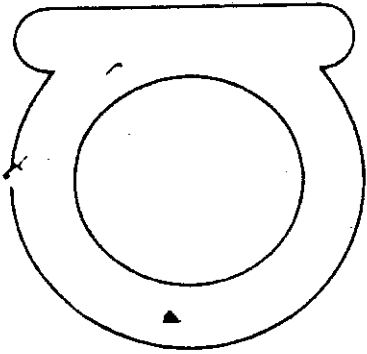
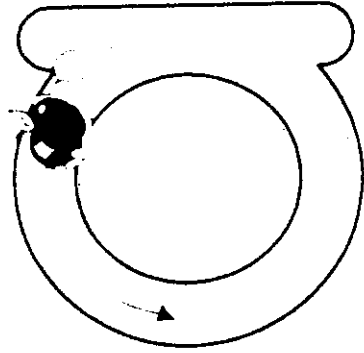
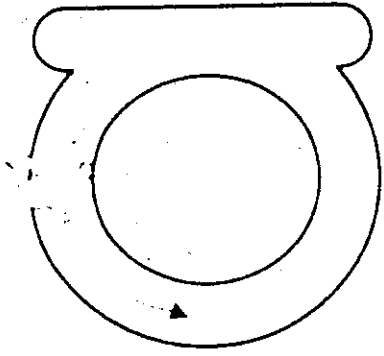

Letter Tracing

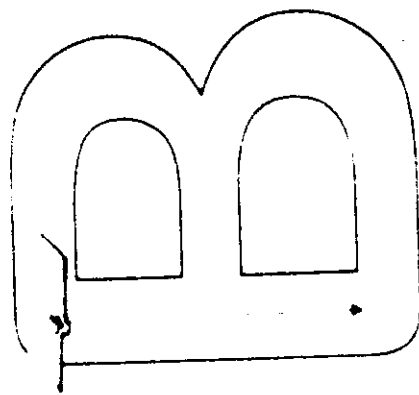
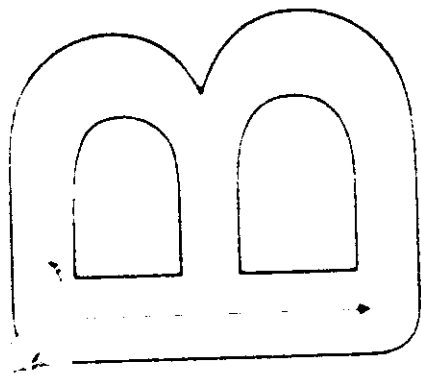
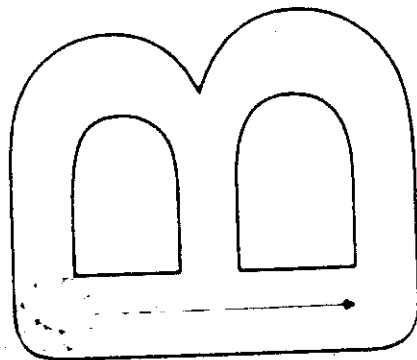
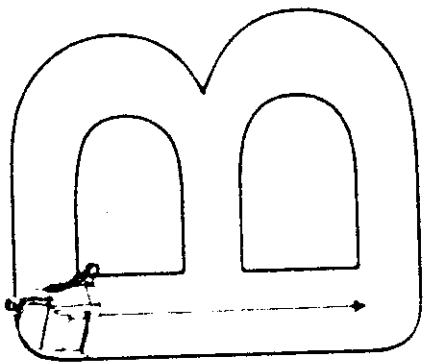
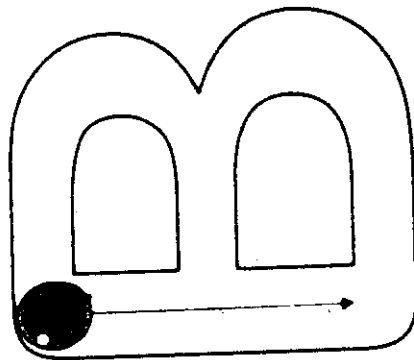
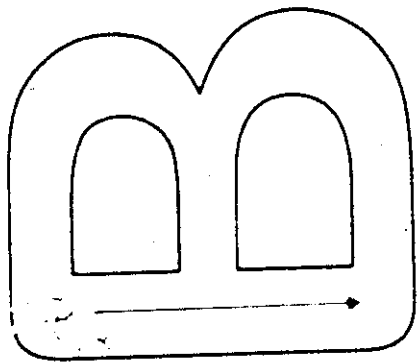



Letter Tracing

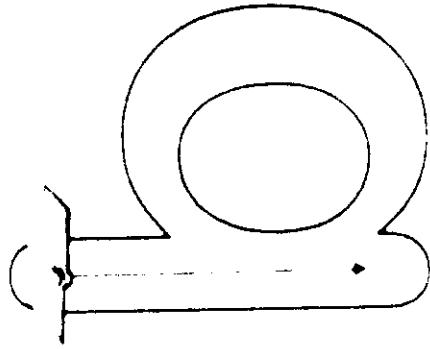
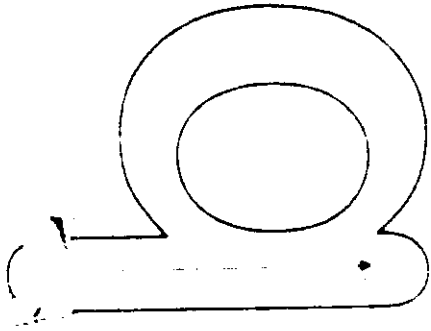
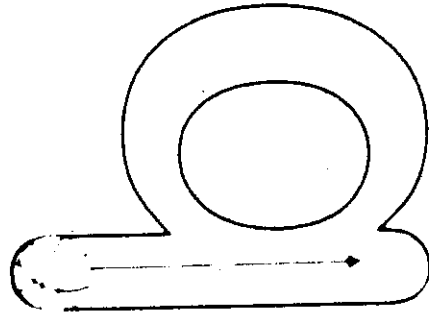
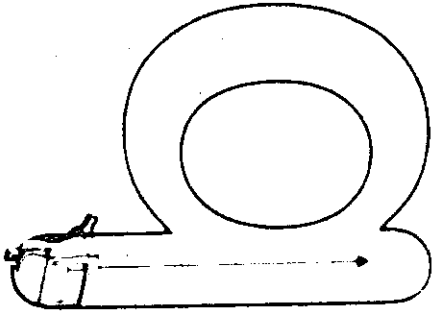
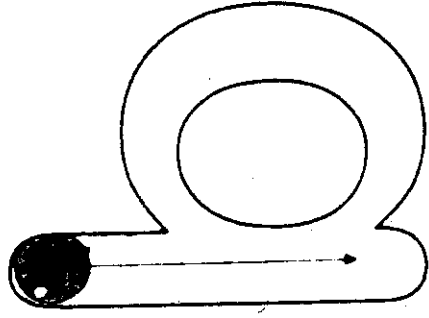
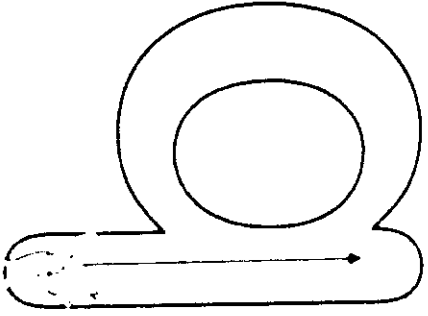

Letter Tracing

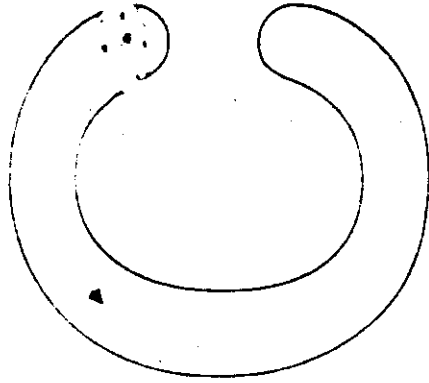
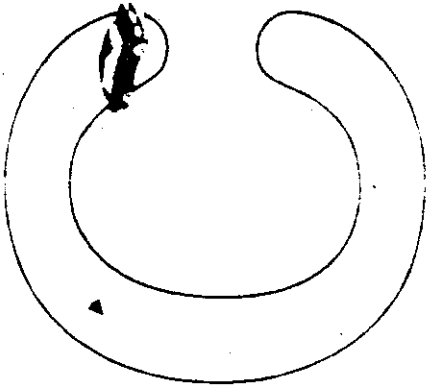
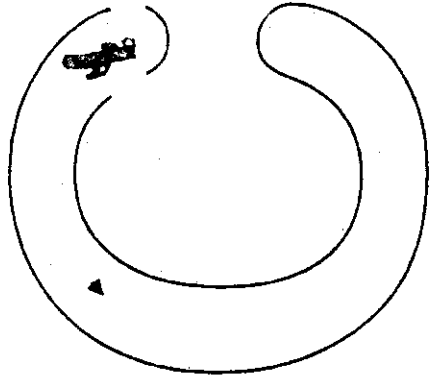
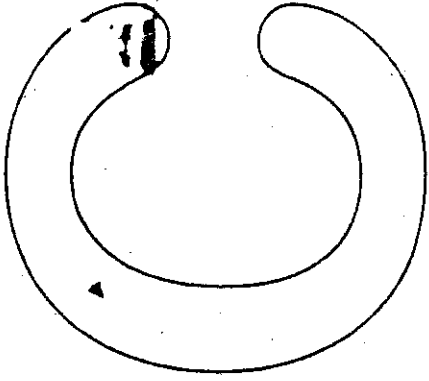
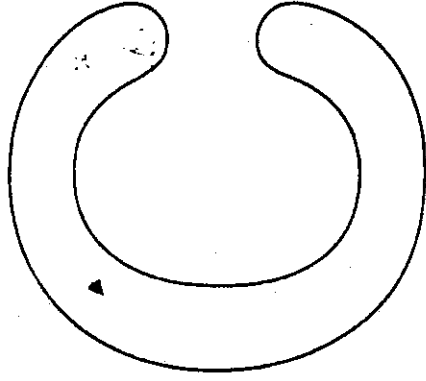
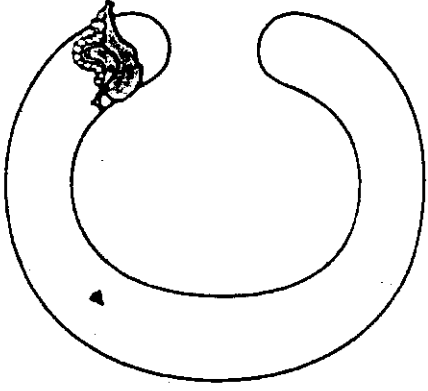

Letter Tracing

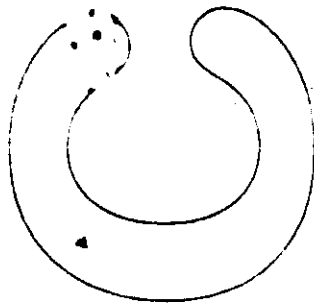
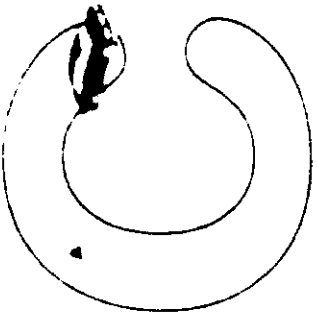
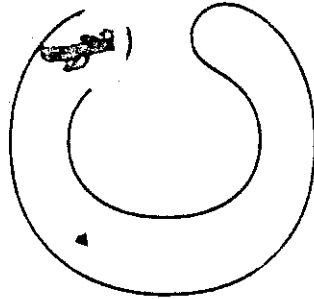
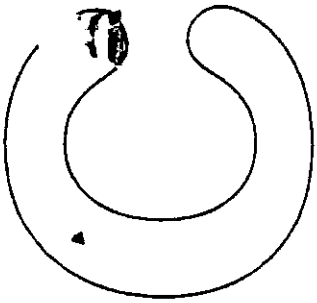
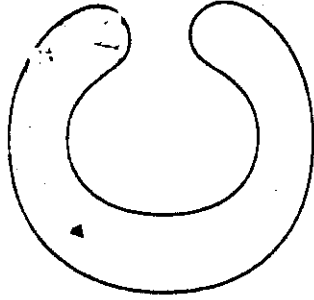
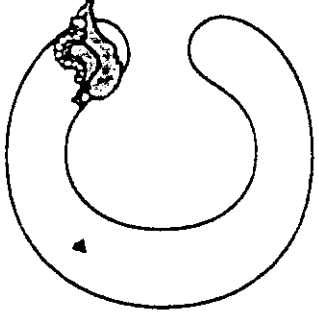

# Letter Tracing

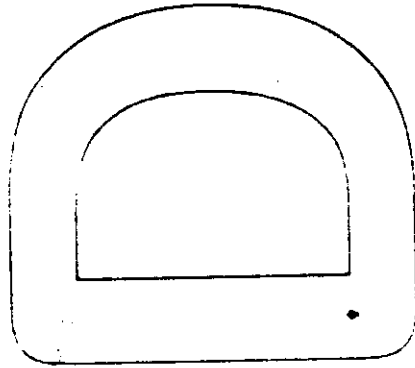
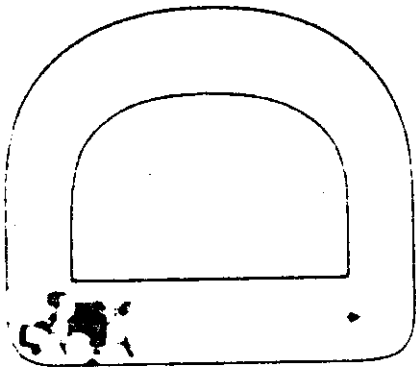
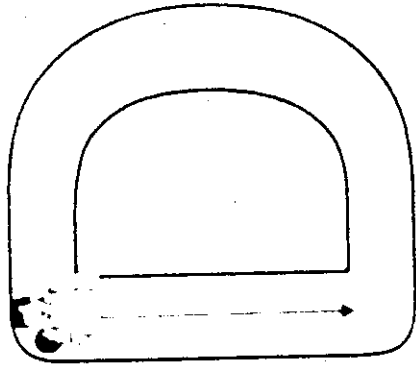
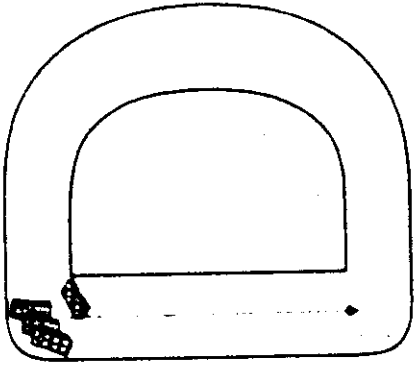
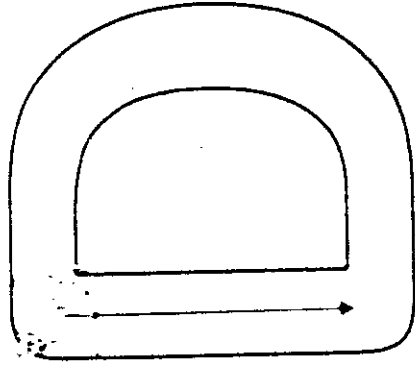
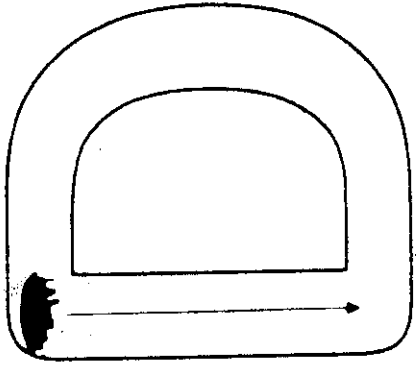

Letter Tracing

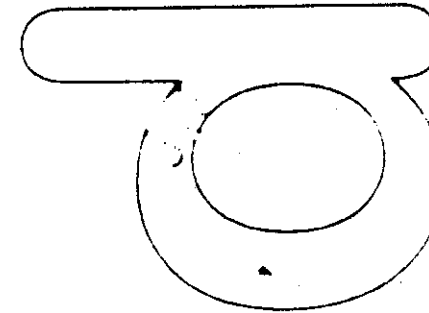
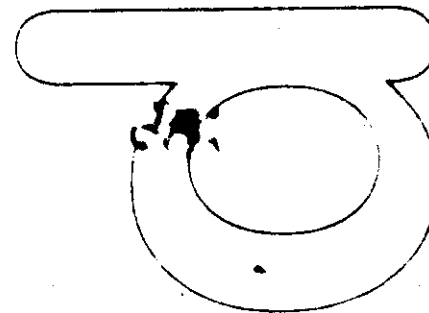
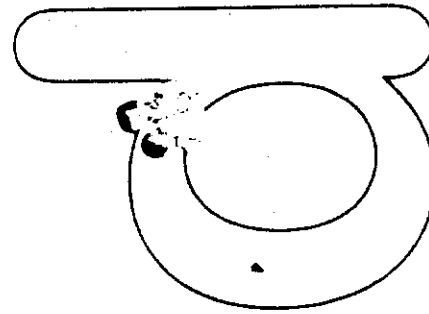
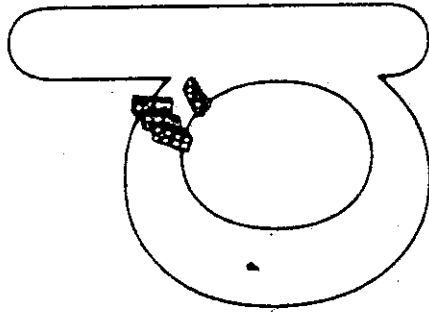
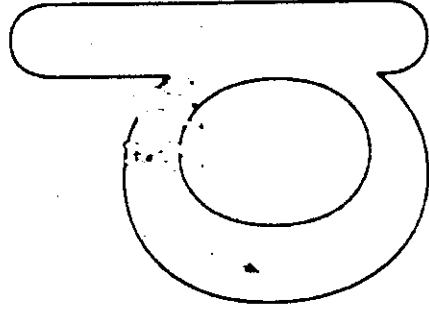
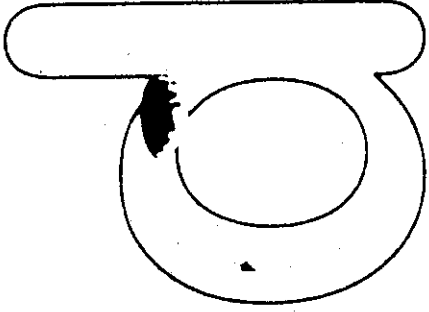

# Letter Tracing

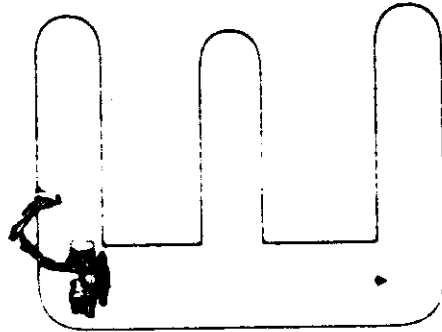
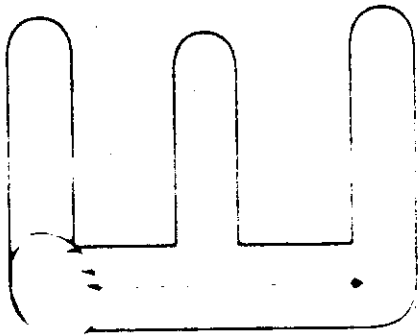
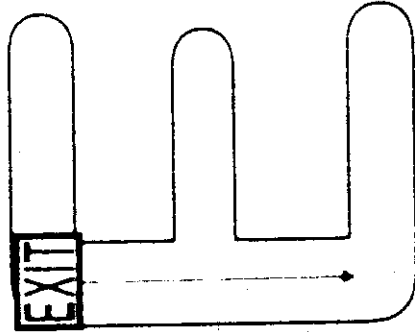
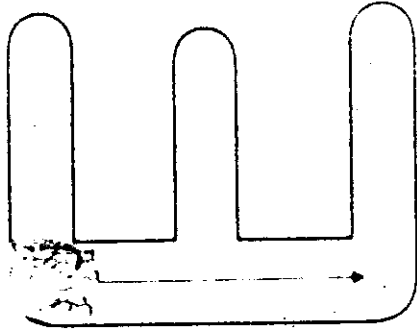
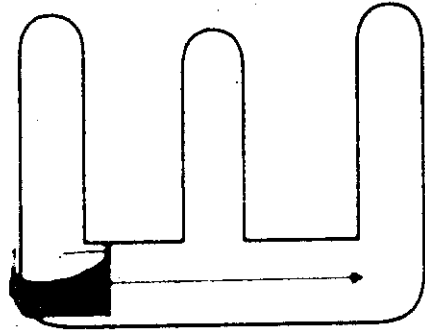
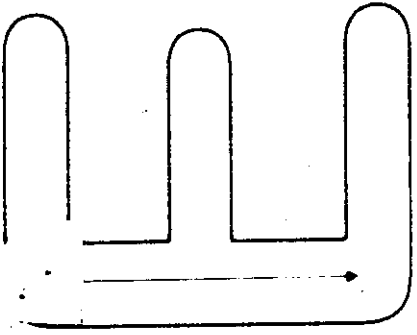

Letter Tracing

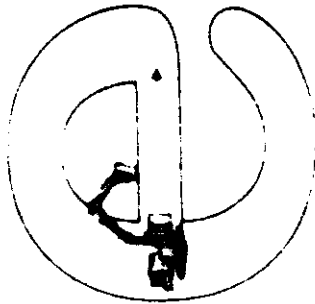
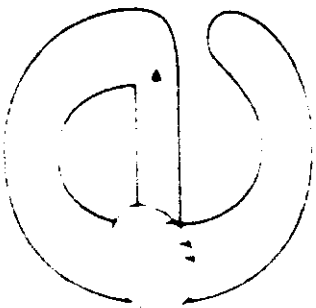
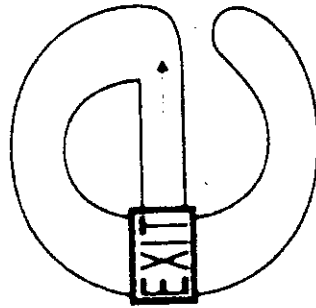
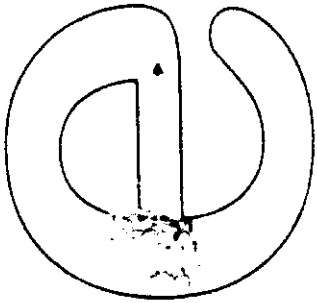
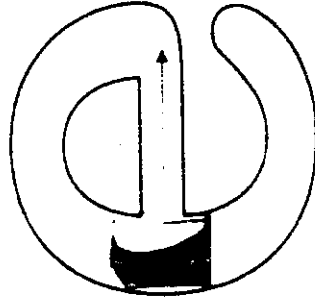
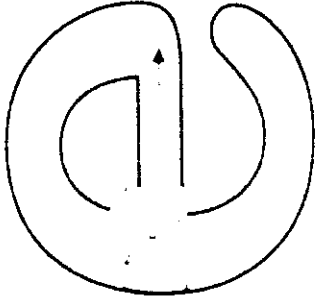

# Letter Tracing

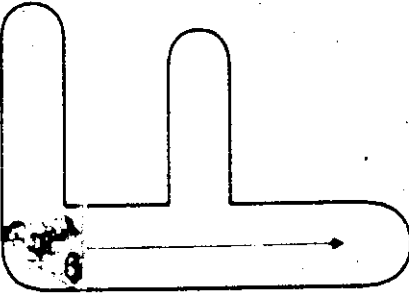
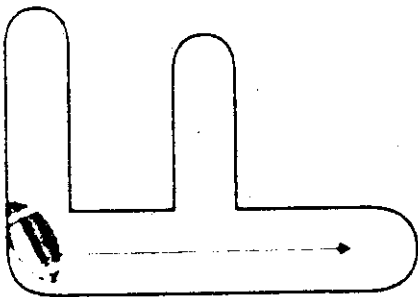
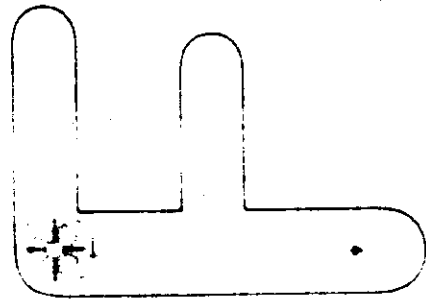
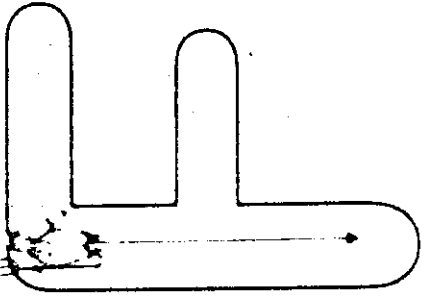
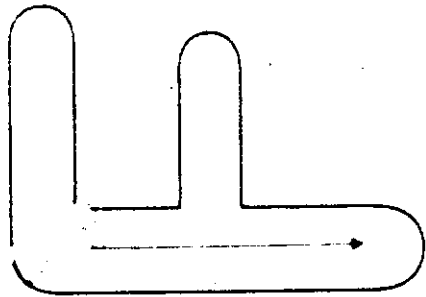
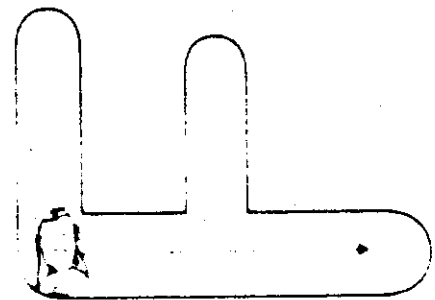



Letter Tracing

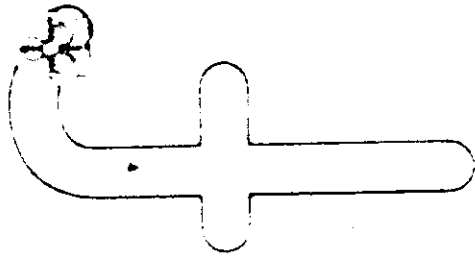
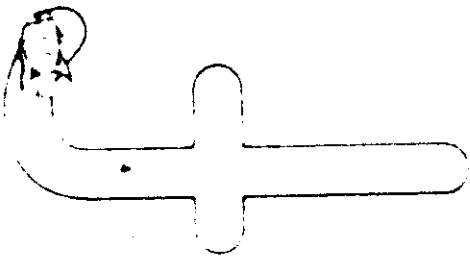
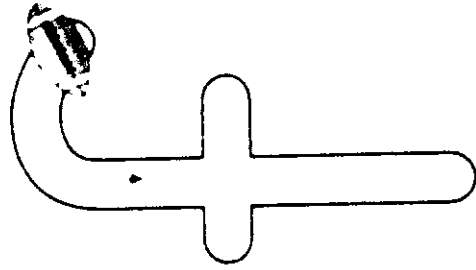
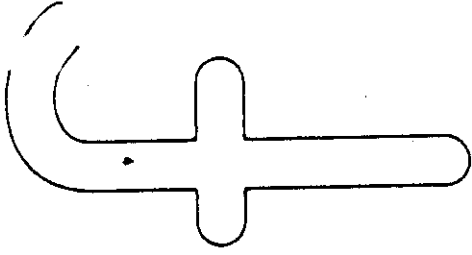
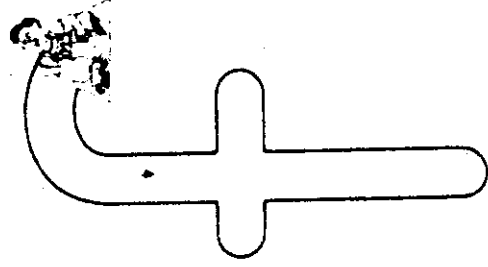
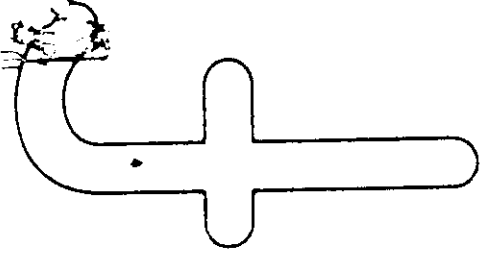

Letter Tracing

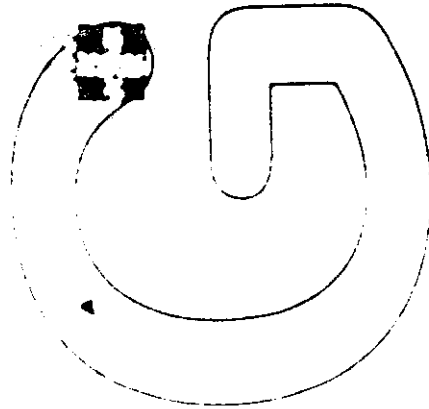
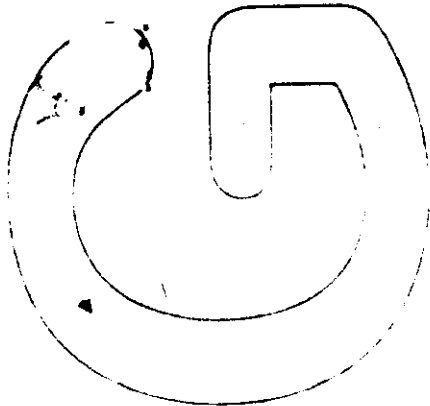
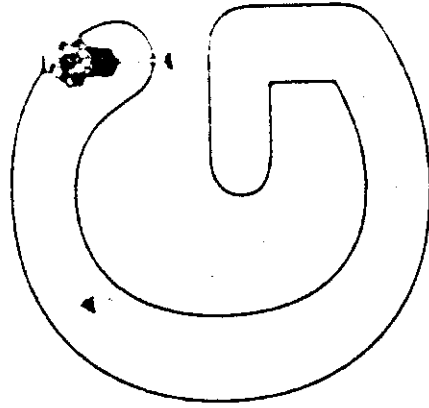
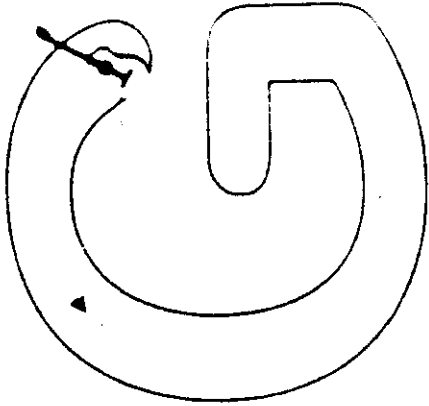
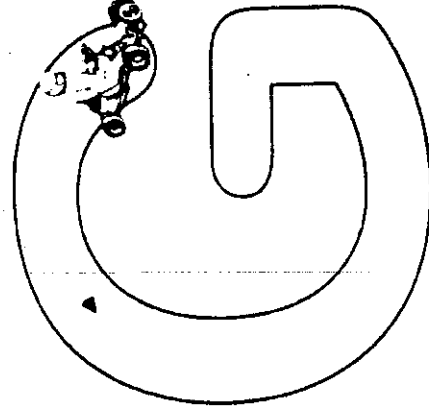
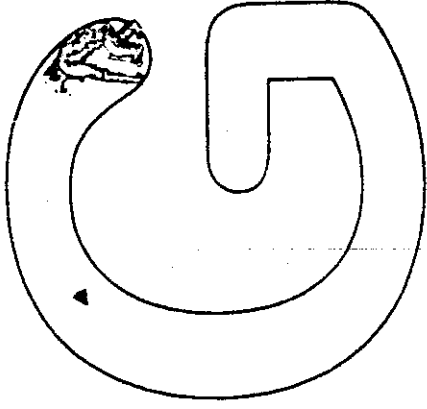

Letter Tracing

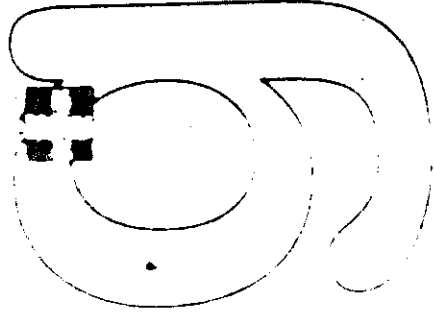
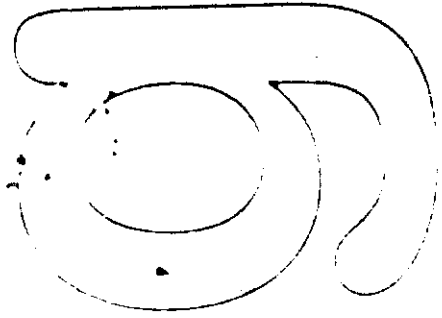
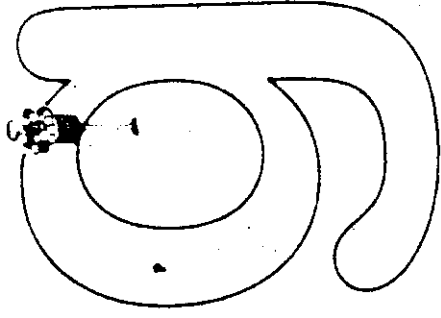
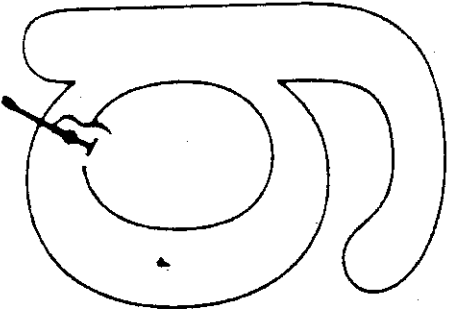
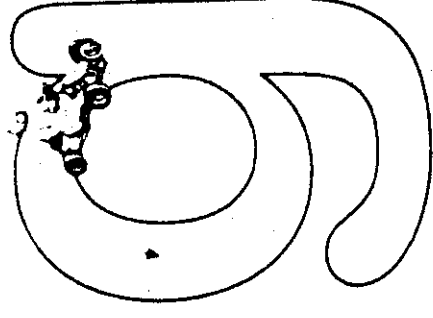
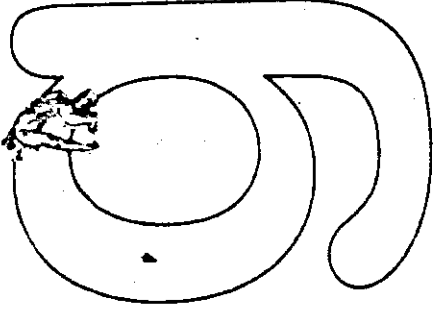

Letter Tracing

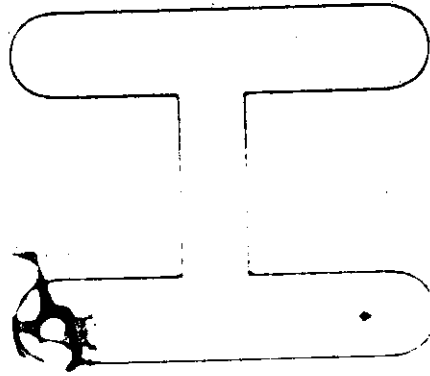
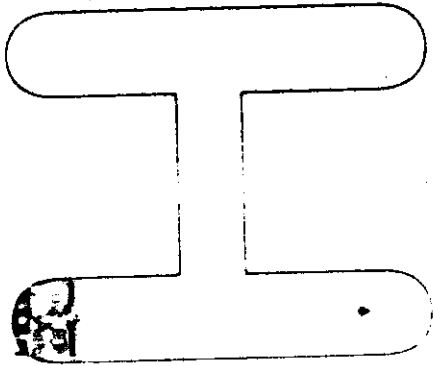
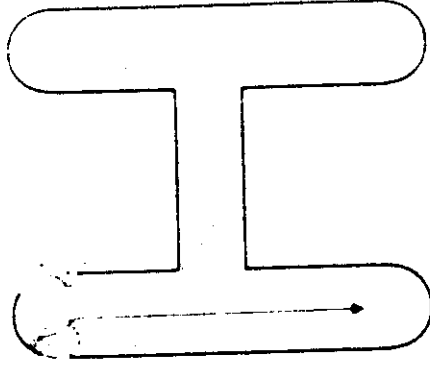
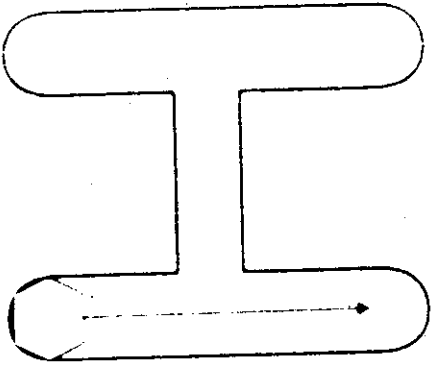
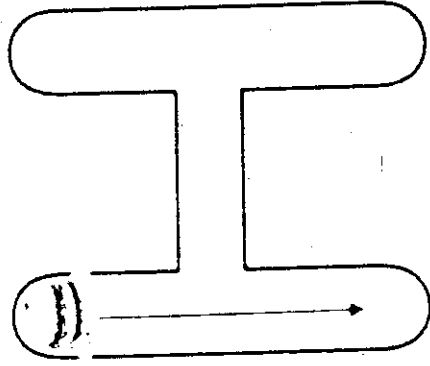
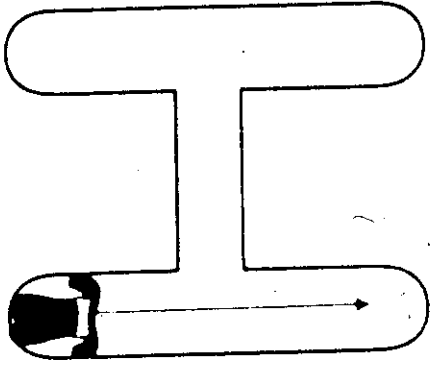

# Letter Tracing

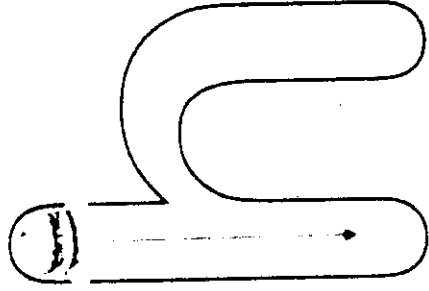
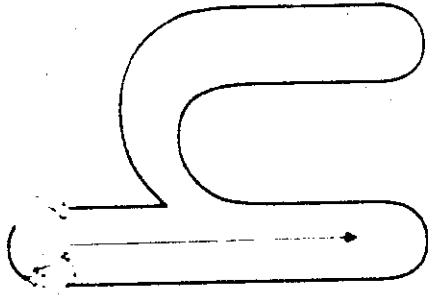
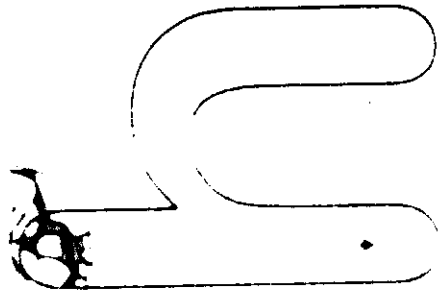
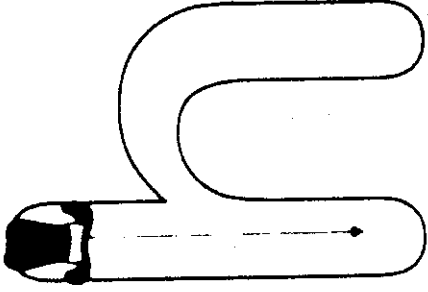
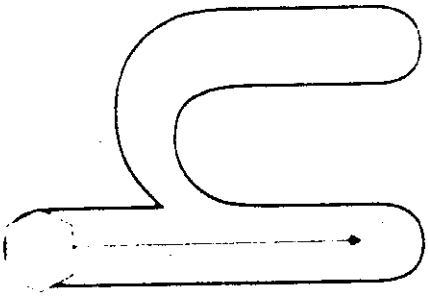
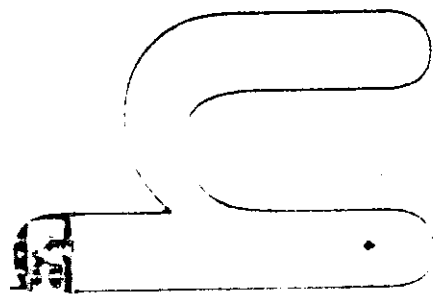

# Letter Tracing

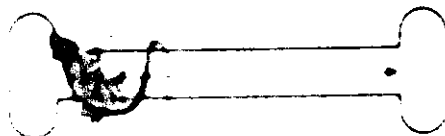
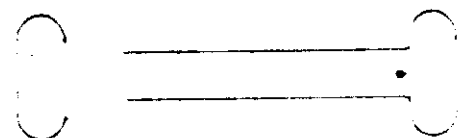
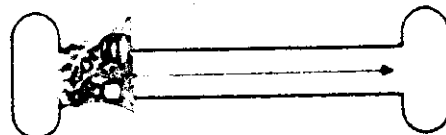
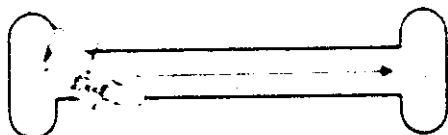
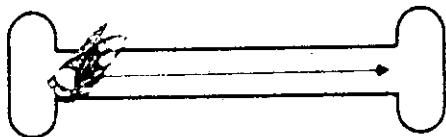
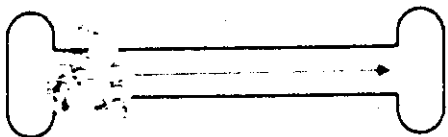

Letter Tracing

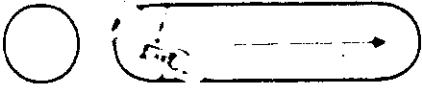

Letter Tracing

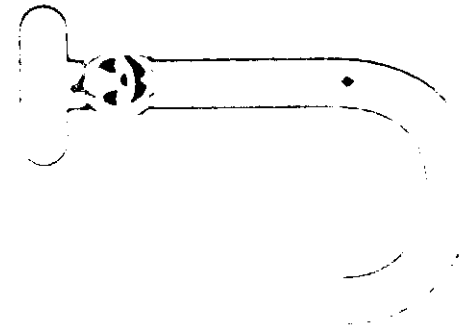
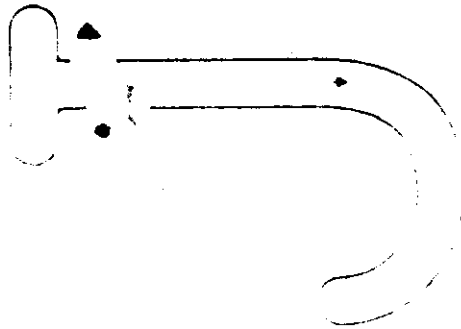
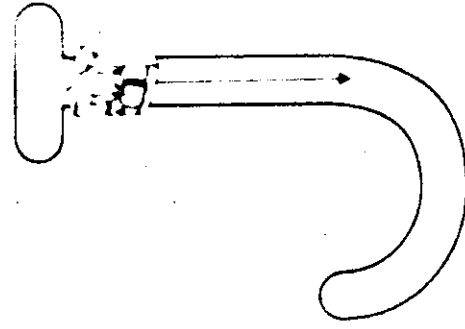
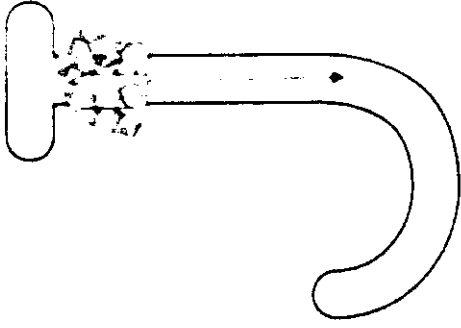
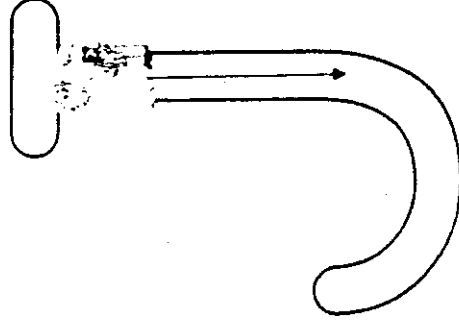
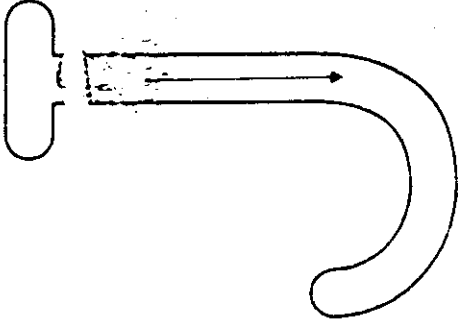



# Letter Tracing

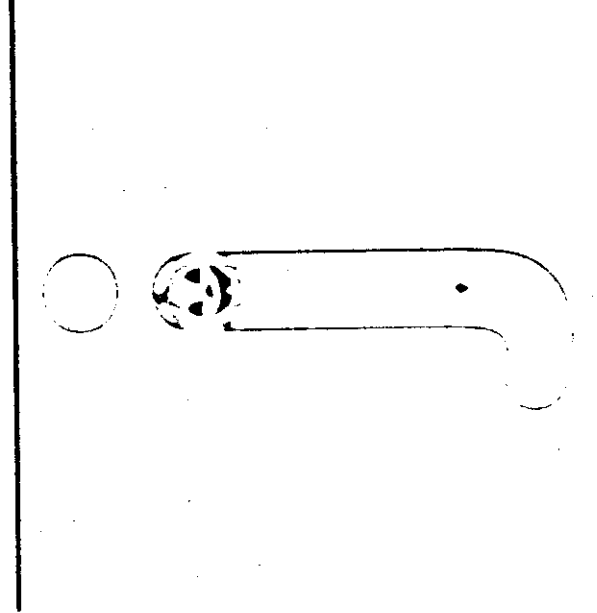
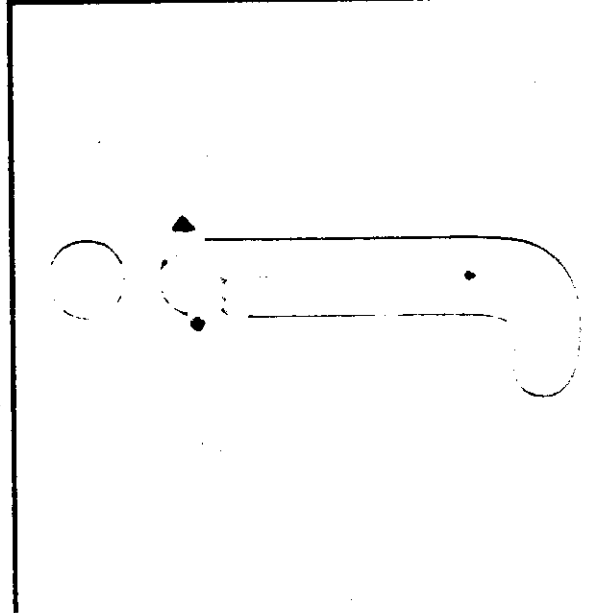
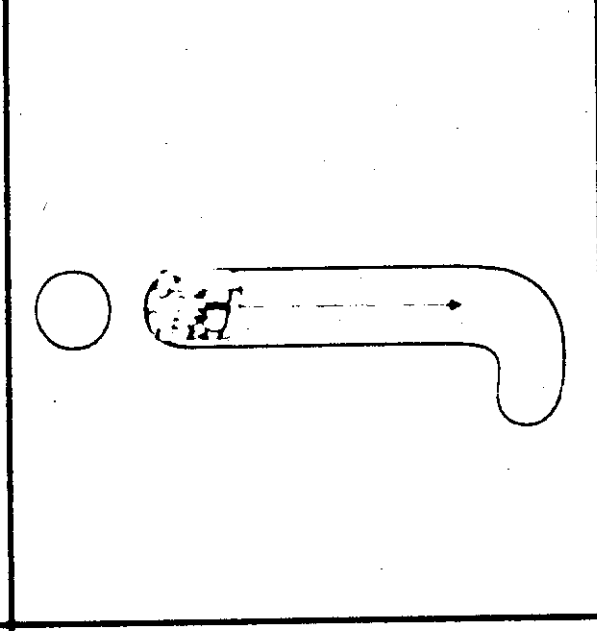
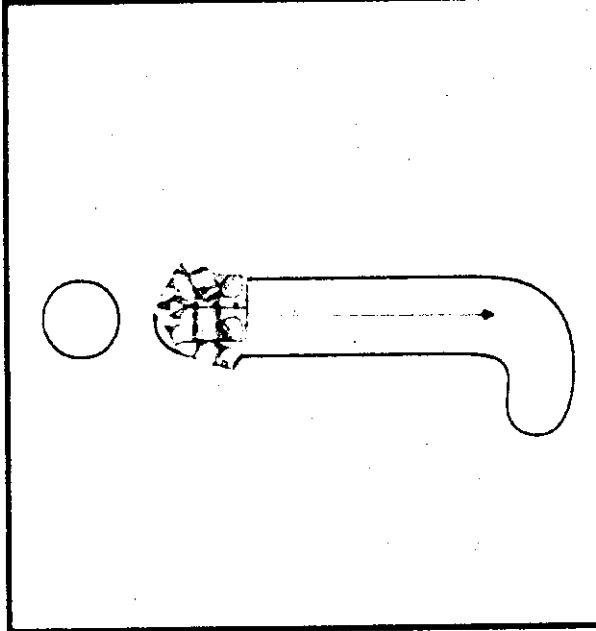
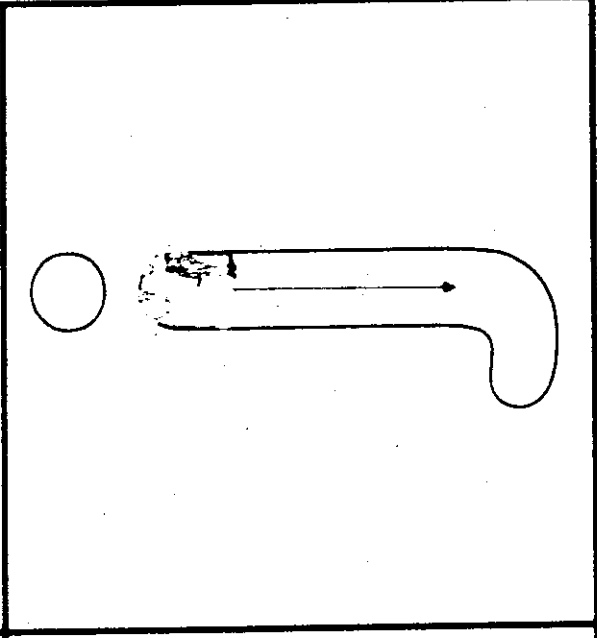
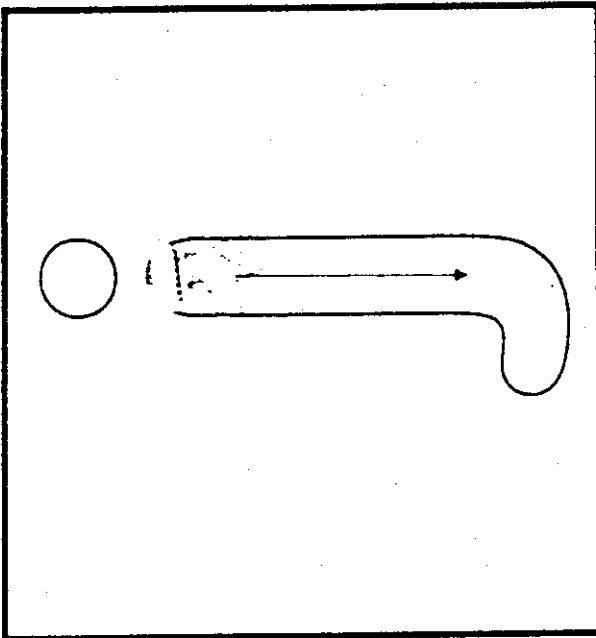

Letter Tracing

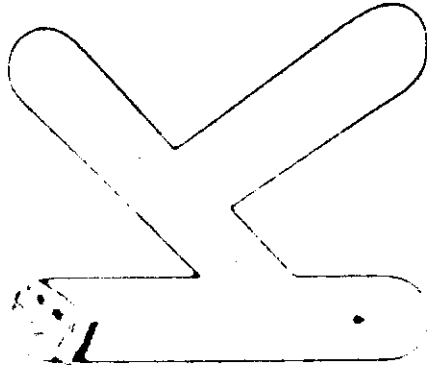
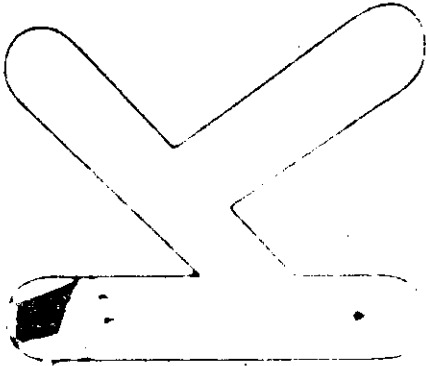
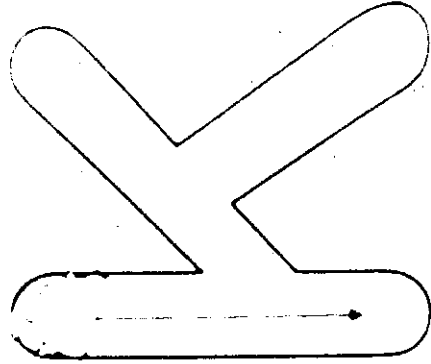
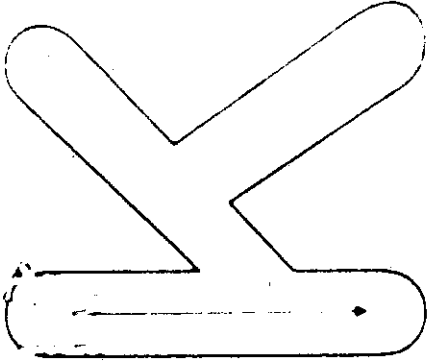
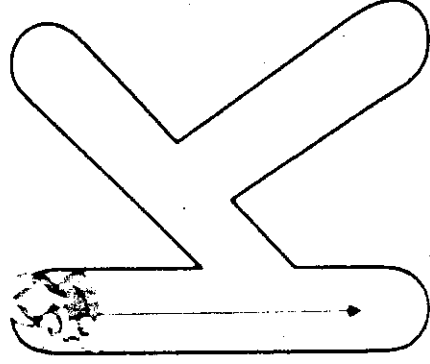
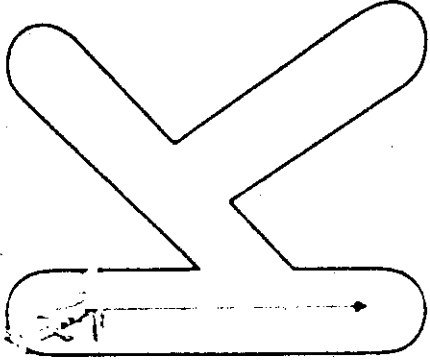

Letter Tracing

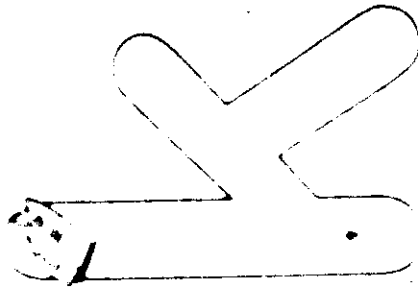
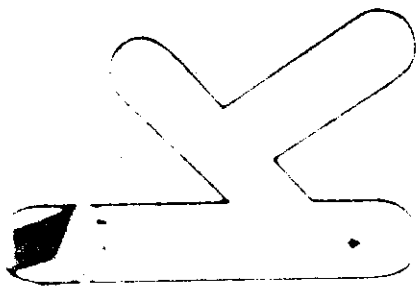
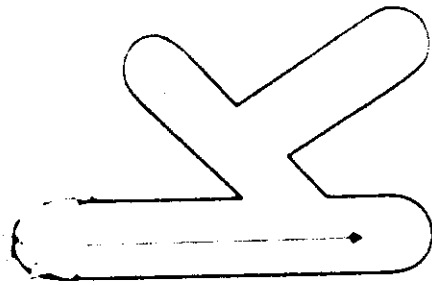
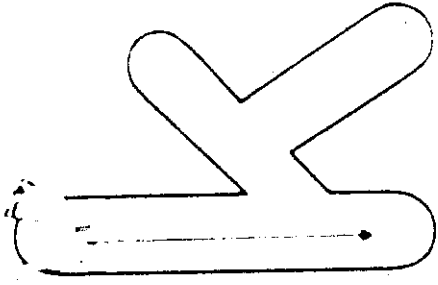
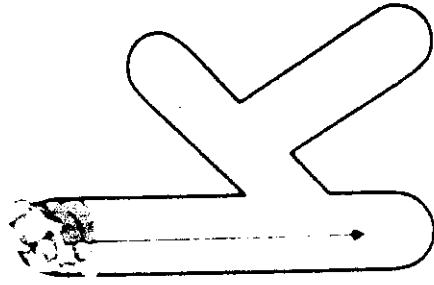
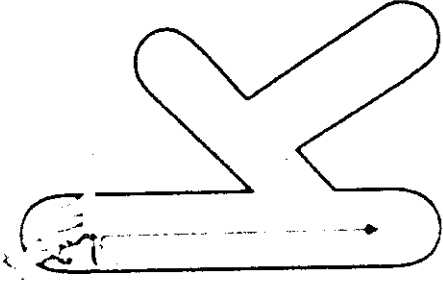

Letter Tracing

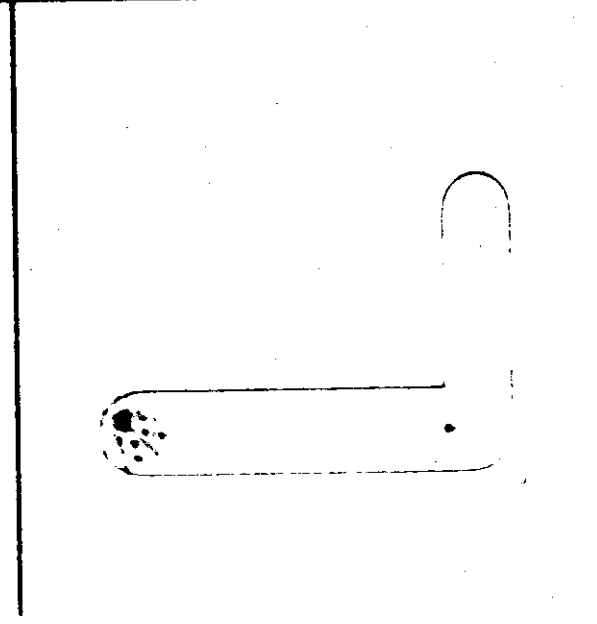
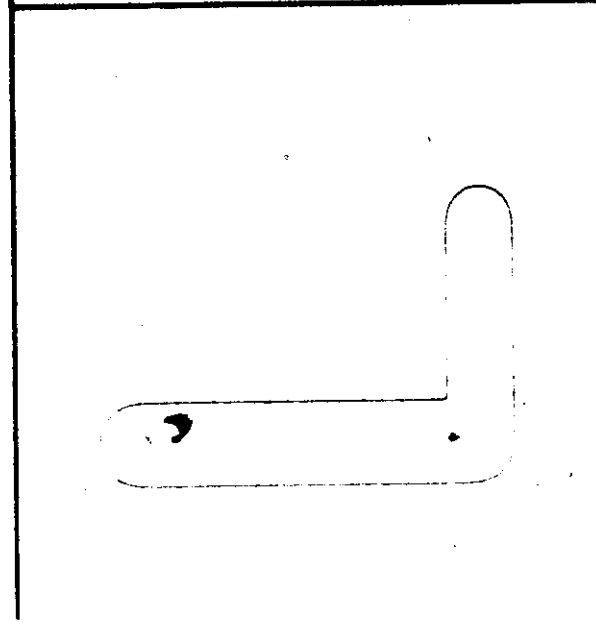
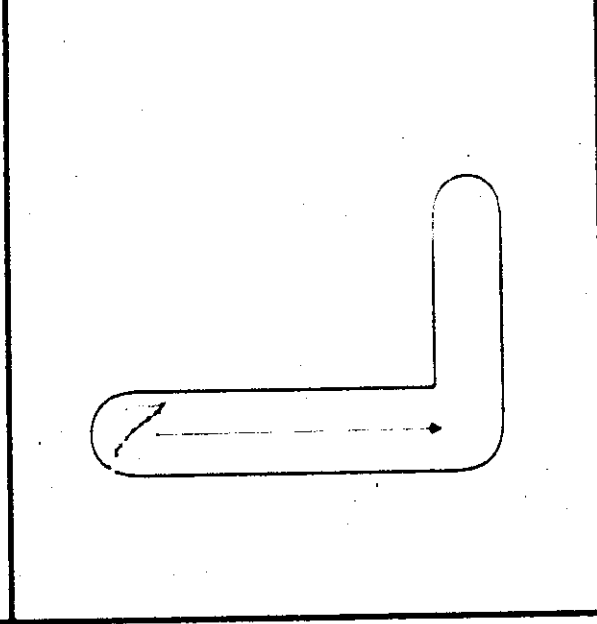
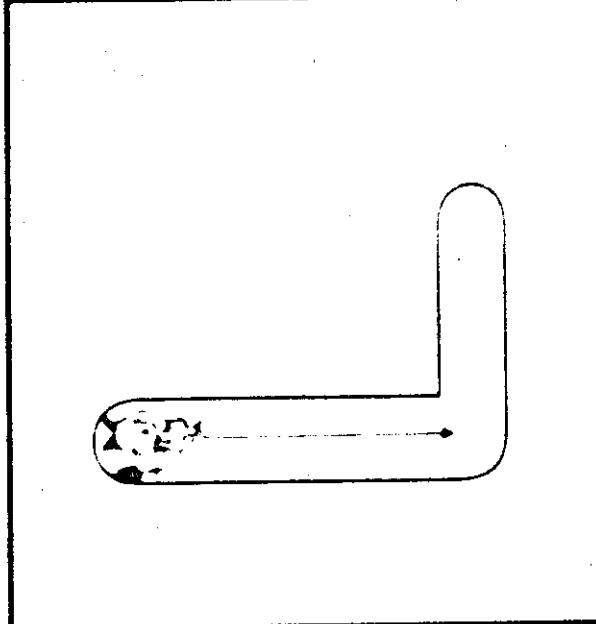
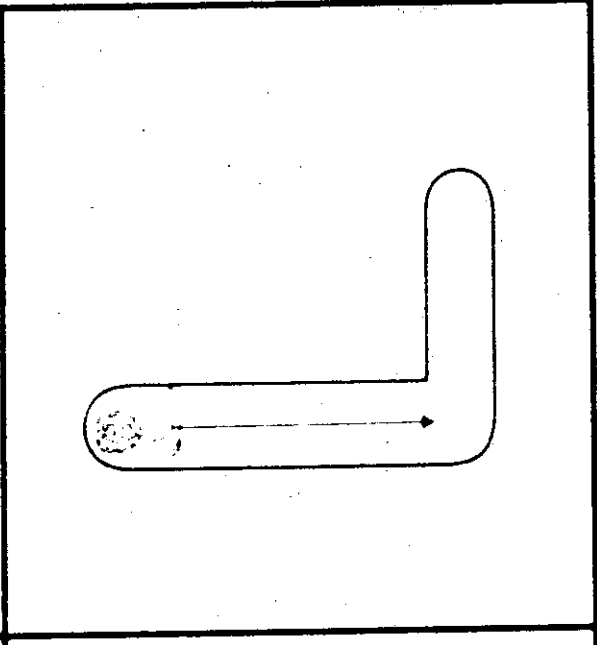
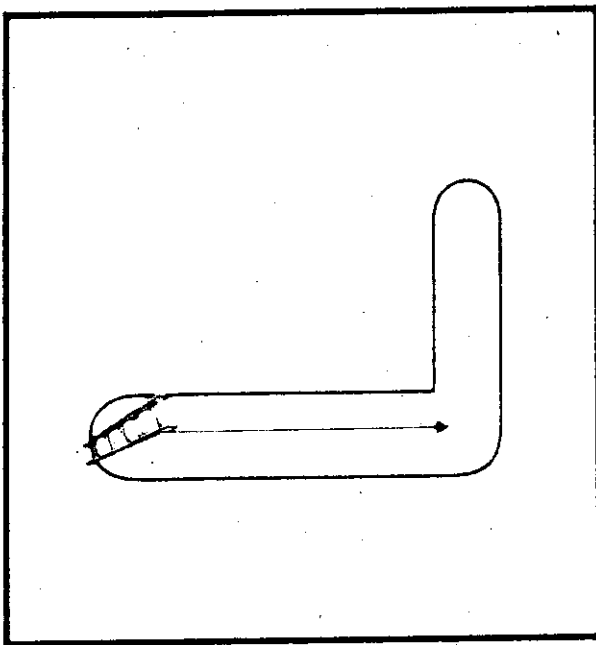

# Letter Tracing

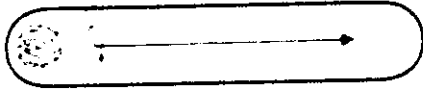
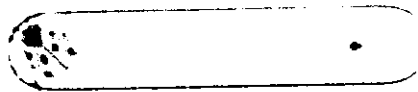
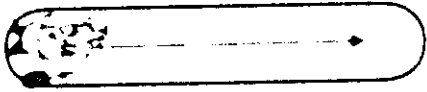

Letter Tracing

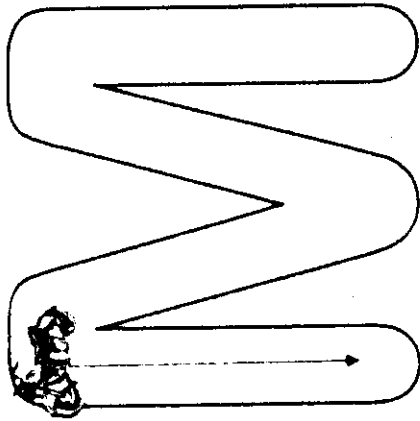
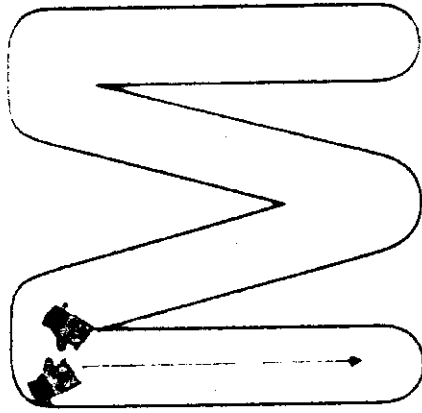
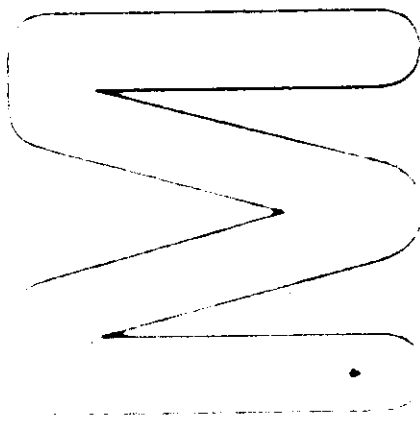
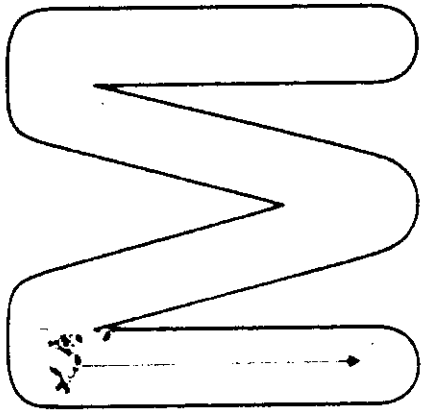
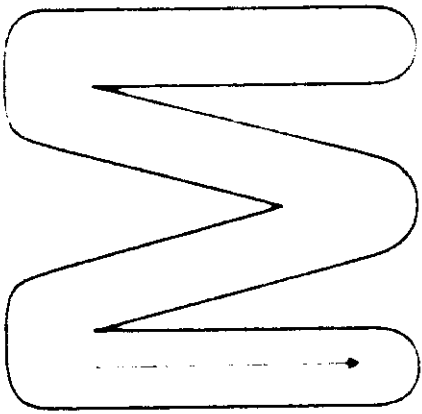
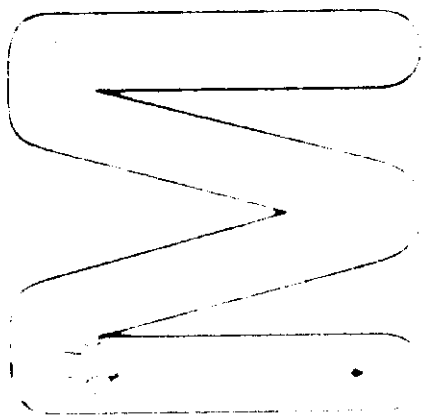

# Letter Tracing

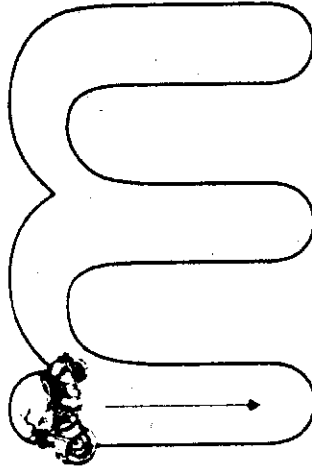
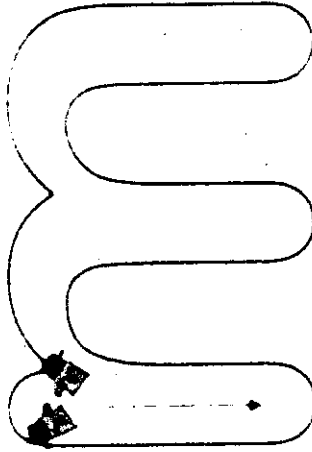
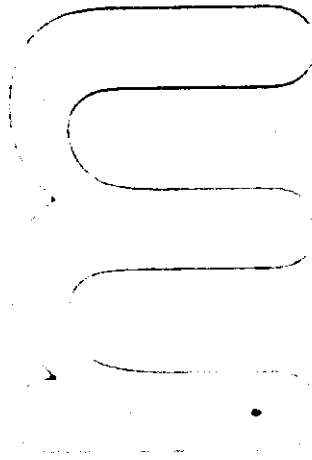
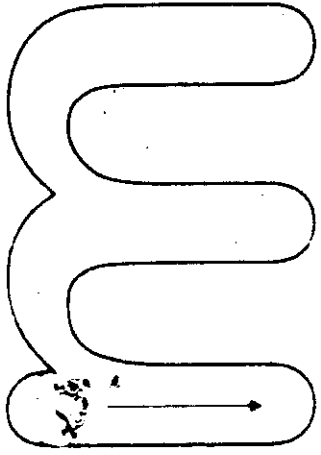
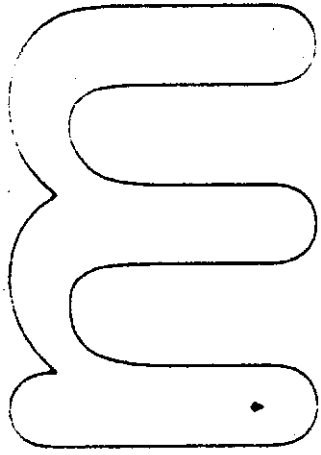
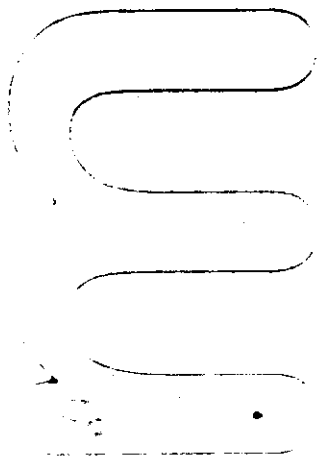

Letter Tracing

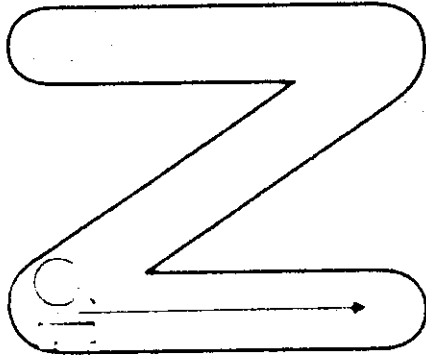
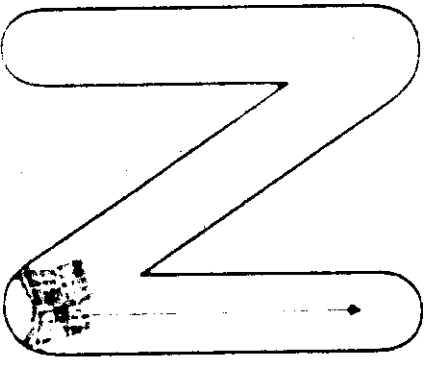
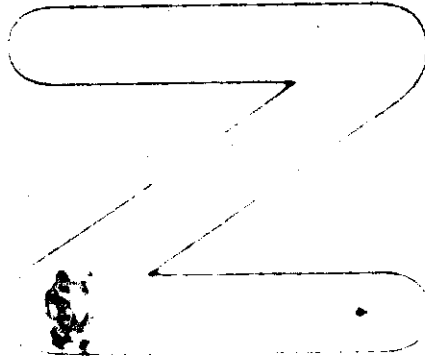
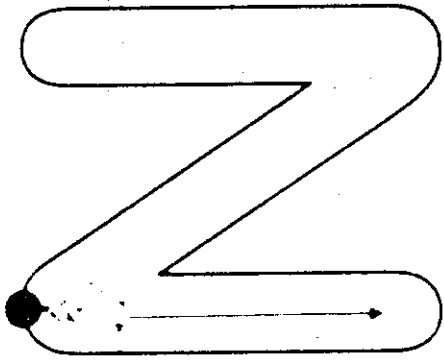
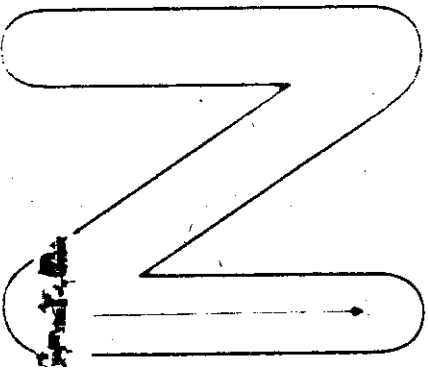
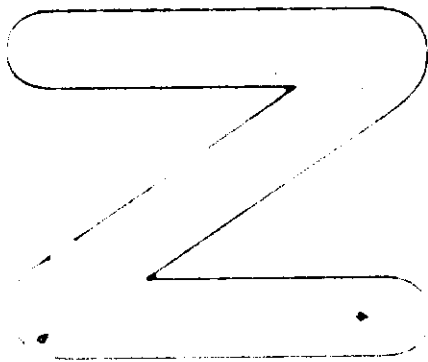



# Letter Tracing

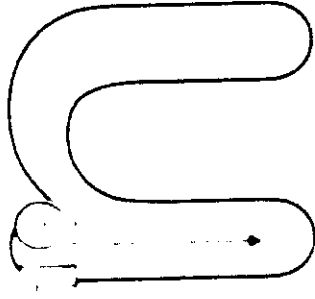
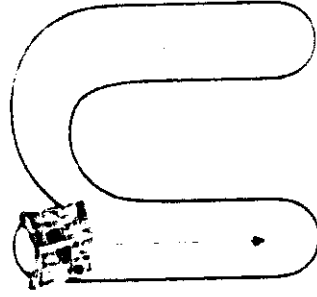
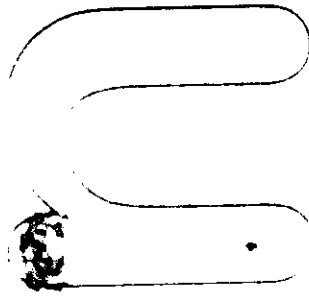
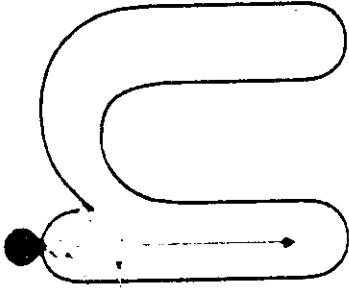
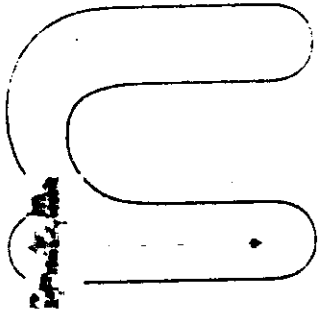
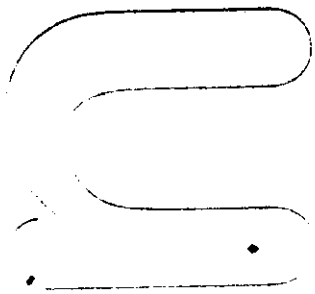

Letter Tracing

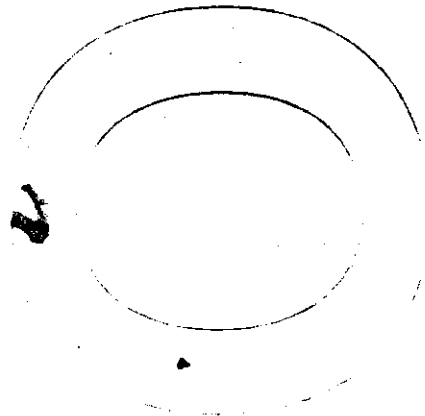
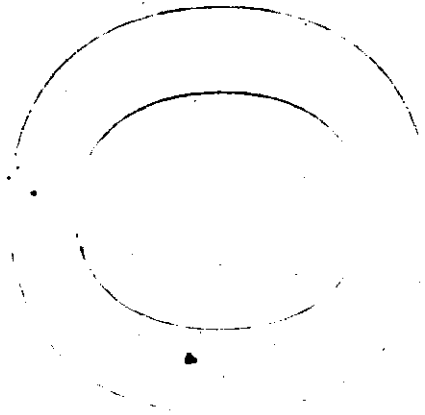
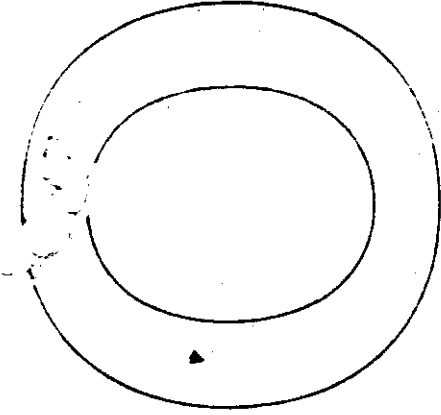
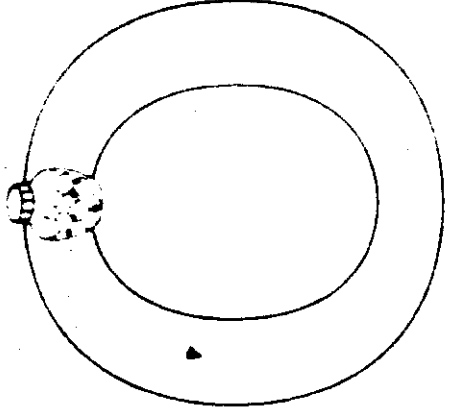
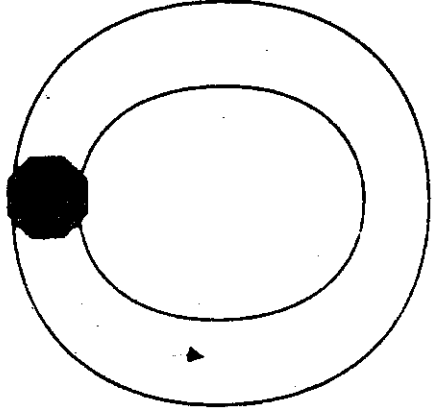
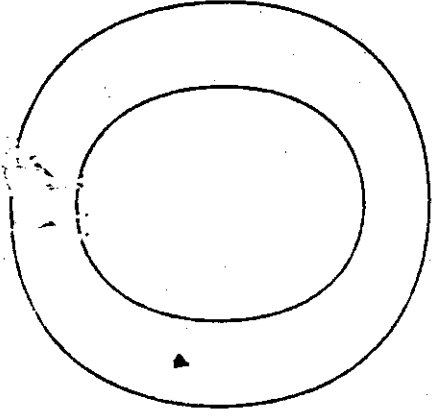

# Letter Tracing

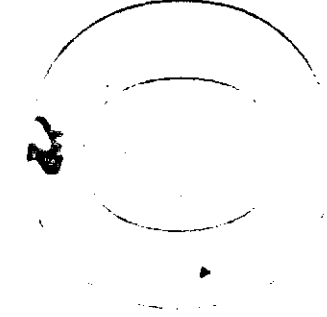
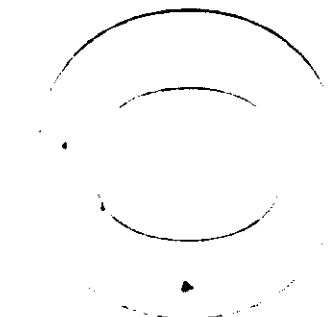
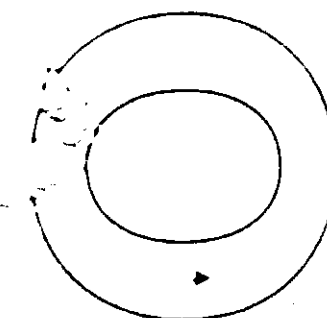
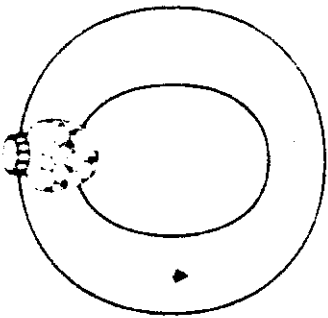
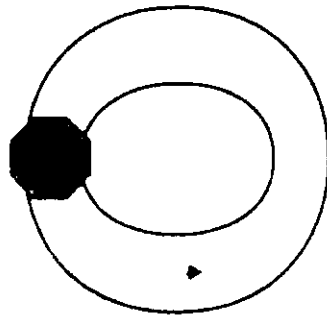
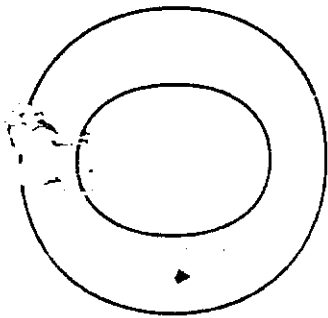

# Letter Tracing

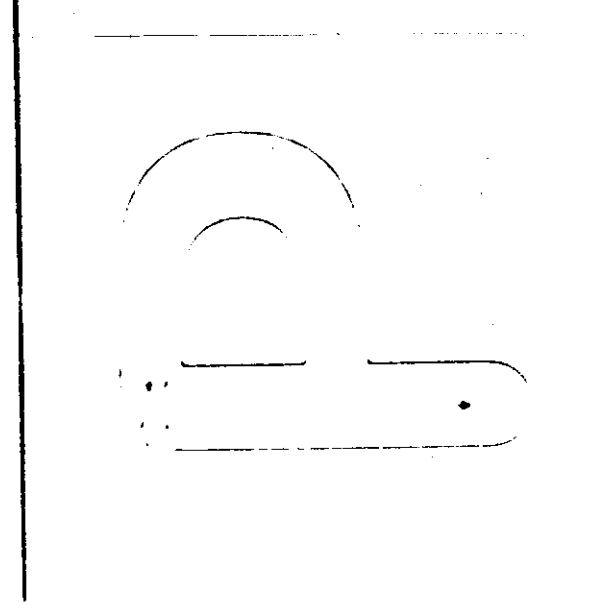
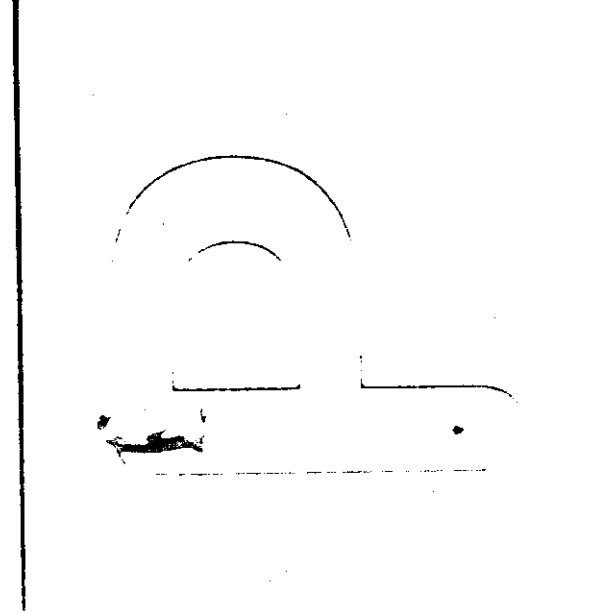
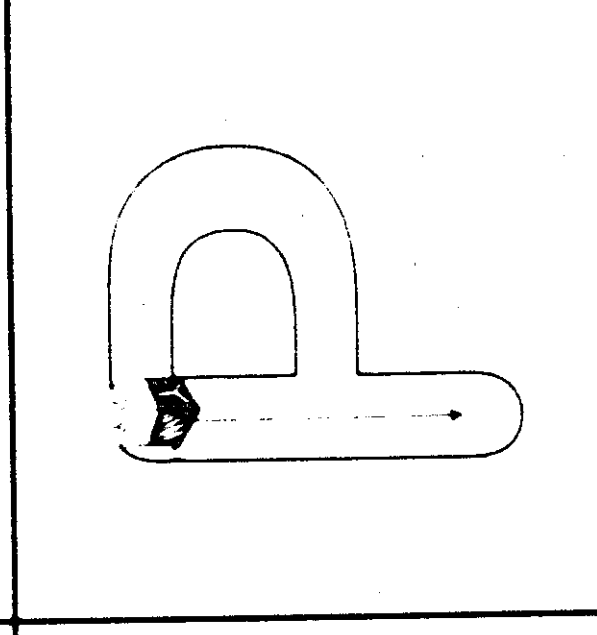
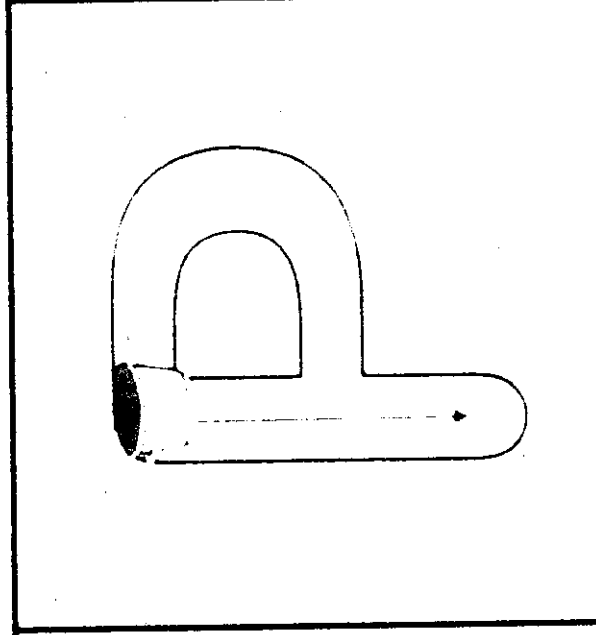
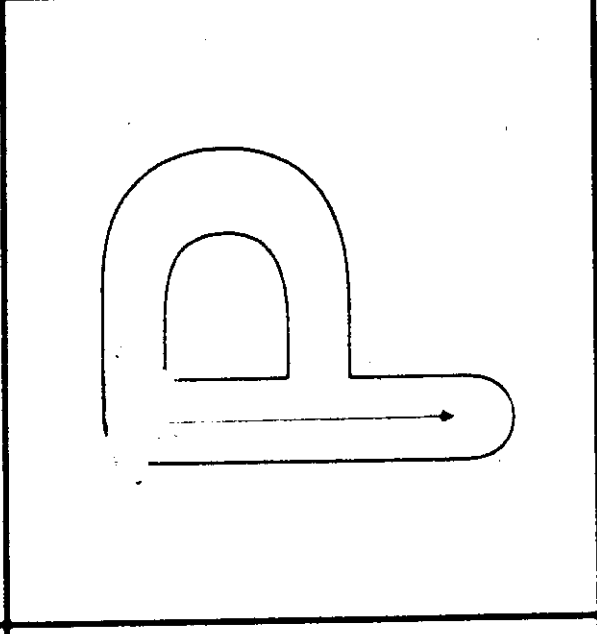
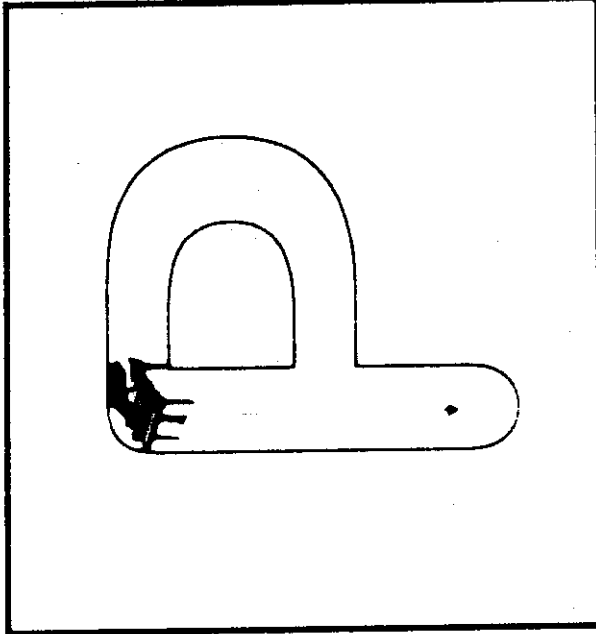

Letter Tracing

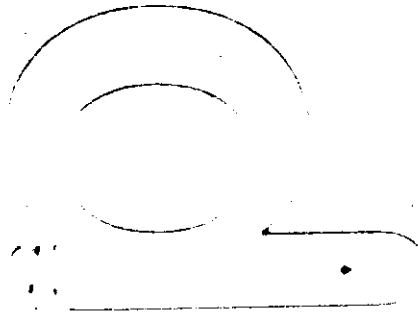
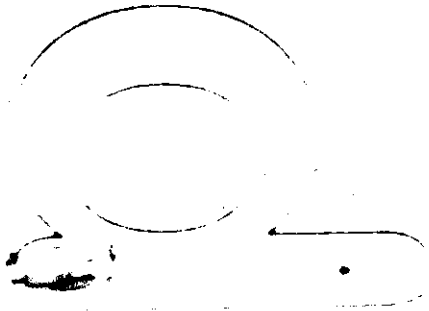
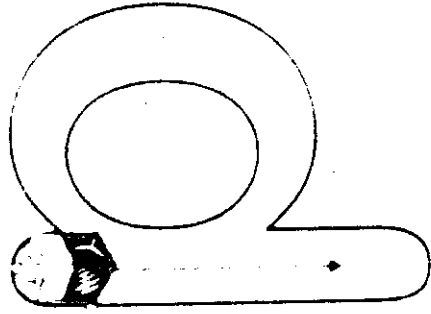
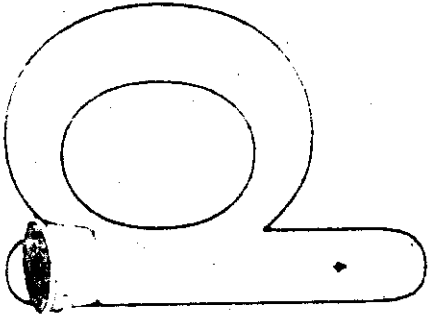
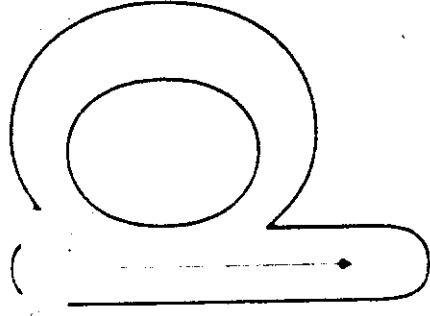
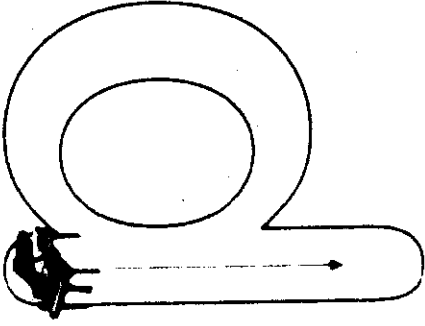

Letter Tracing

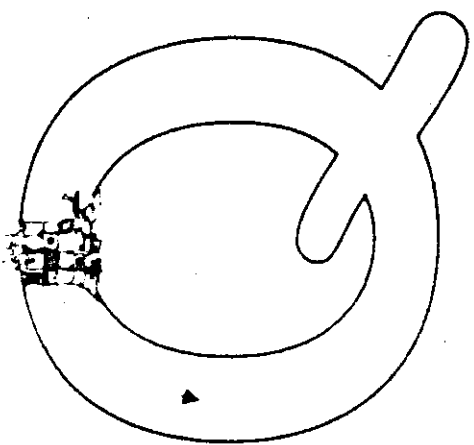
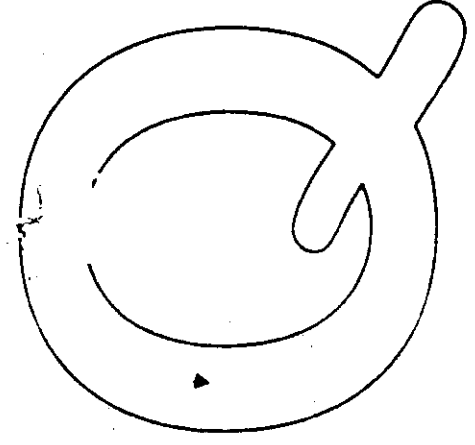
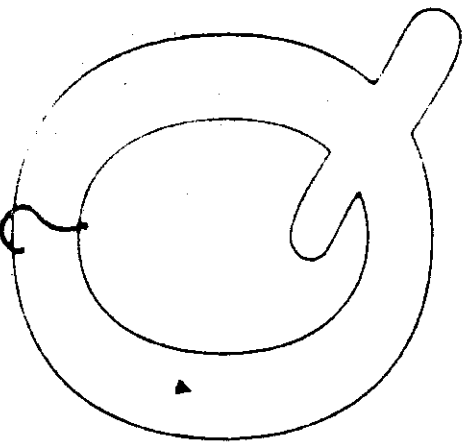
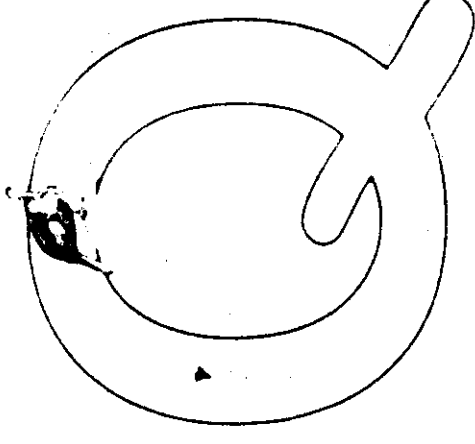
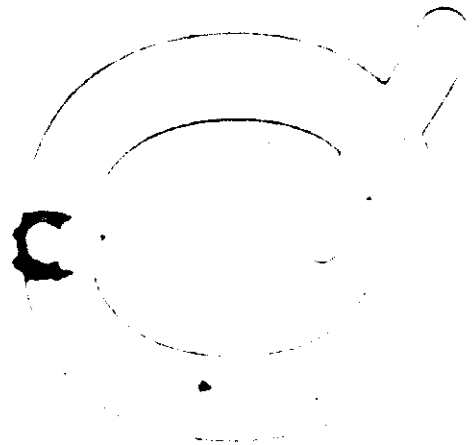
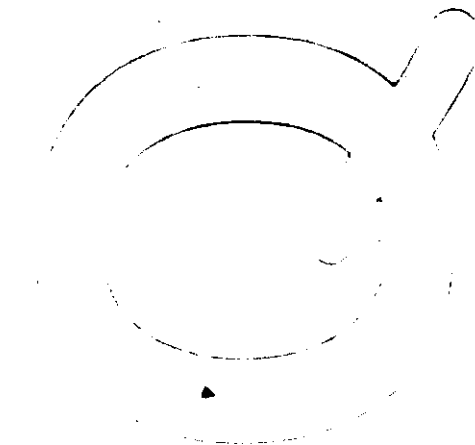
Letter Tracing

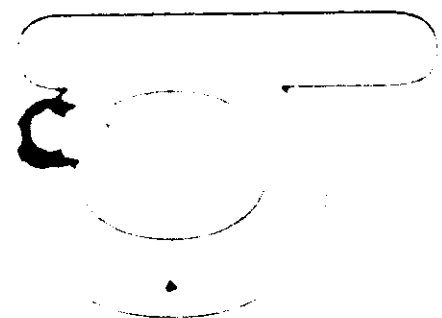
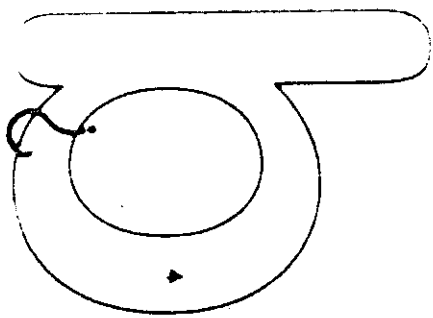
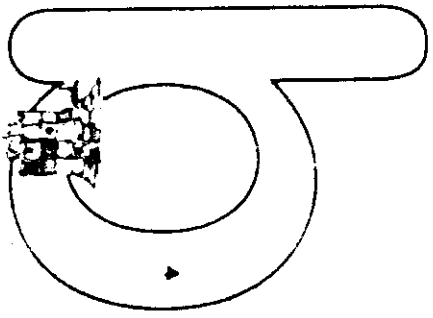
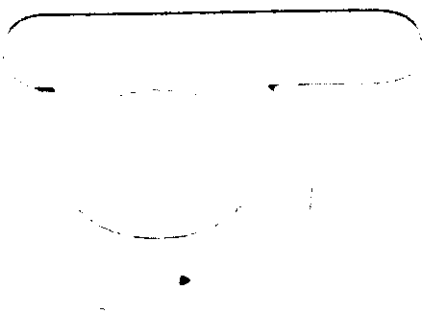
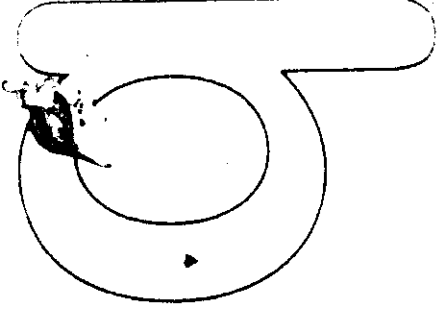
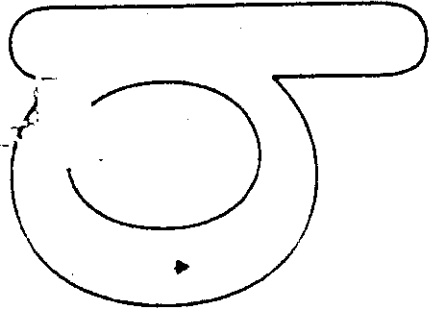

Letter Tracing



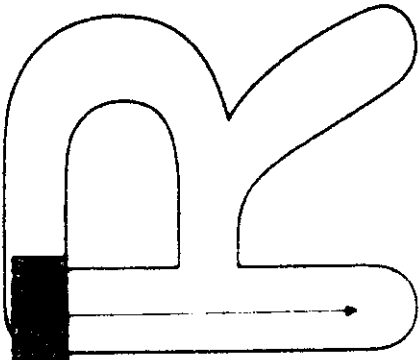
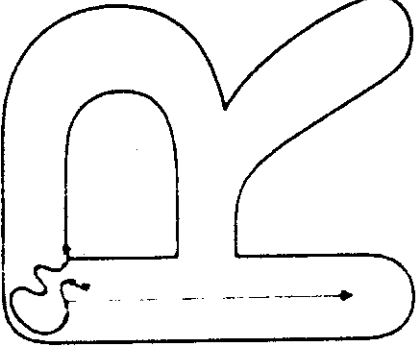
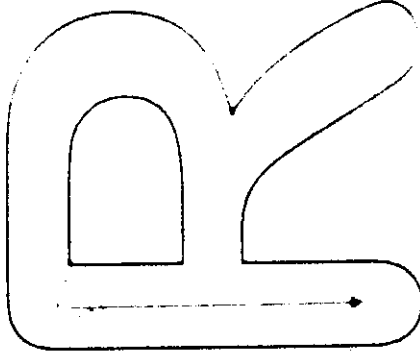
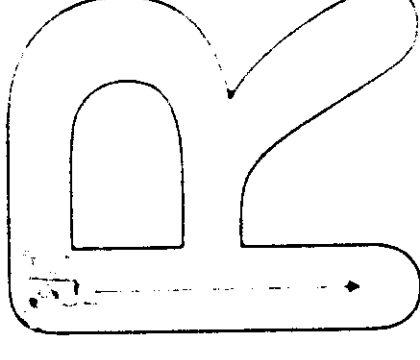
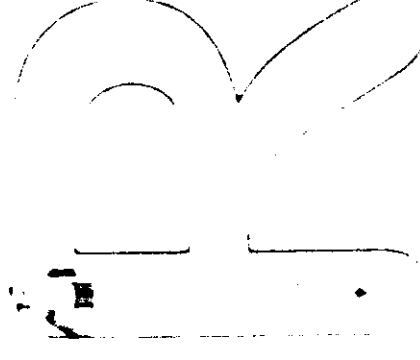
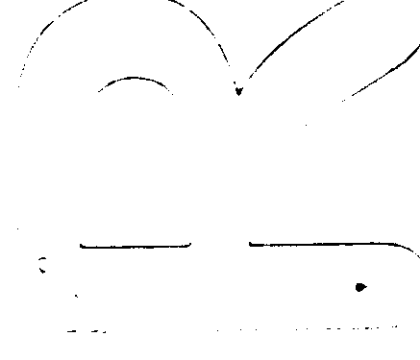

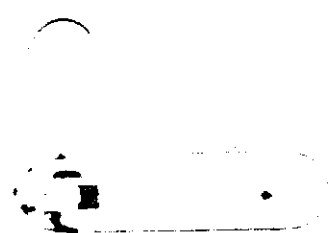
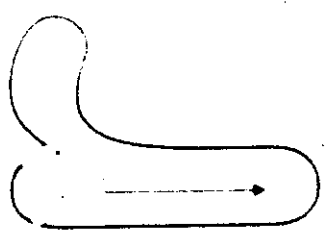
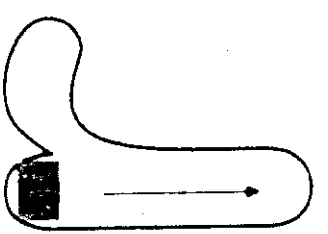
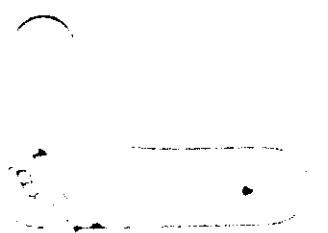
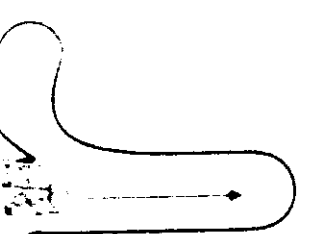
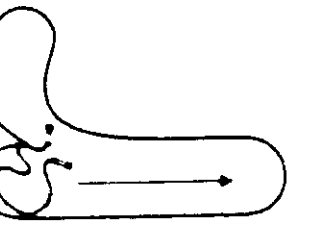

# Letter Tracing

Letter Tracing

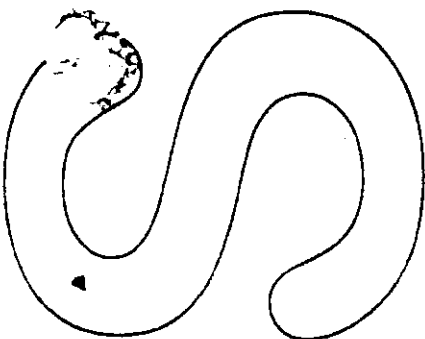
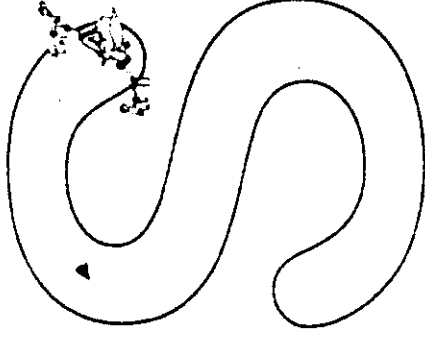
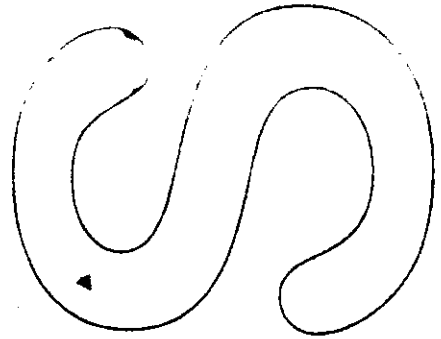
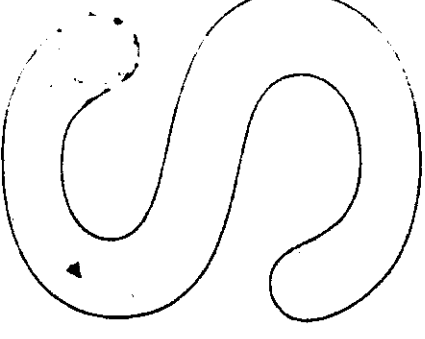
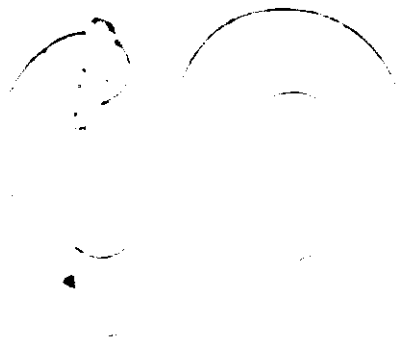
Letter Tracing



Letter Tracing

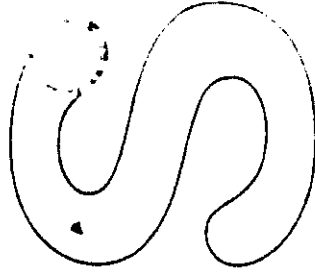
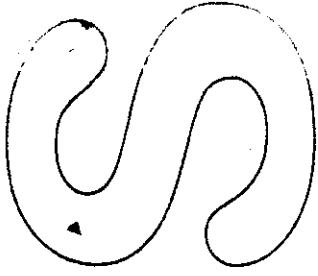
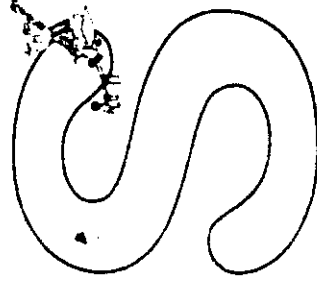
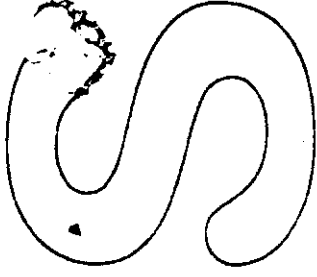

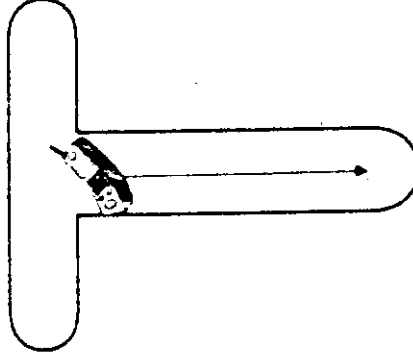
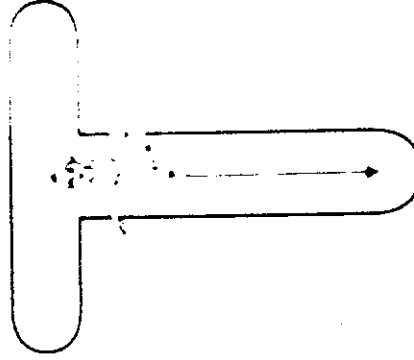
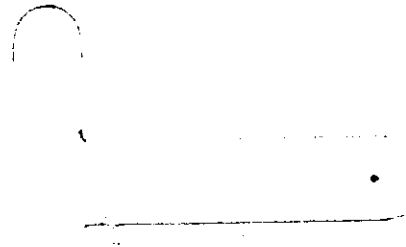
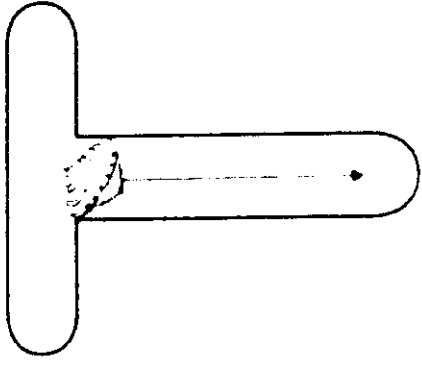
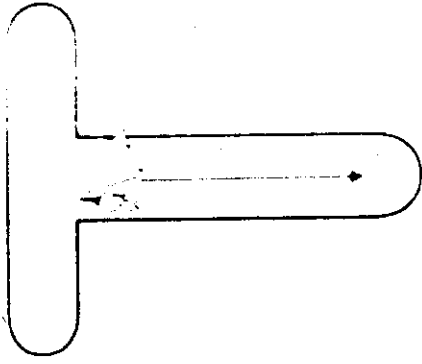
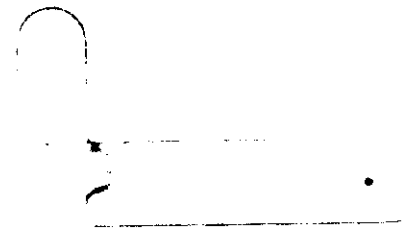
# Letter Tracing

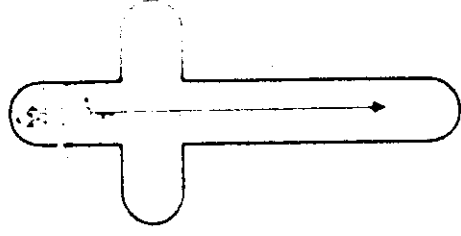
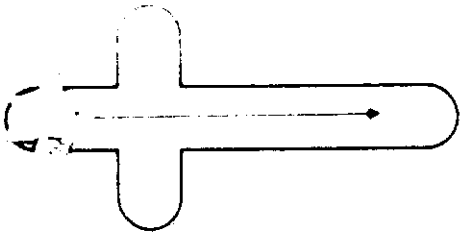
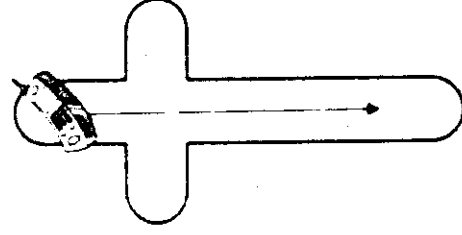
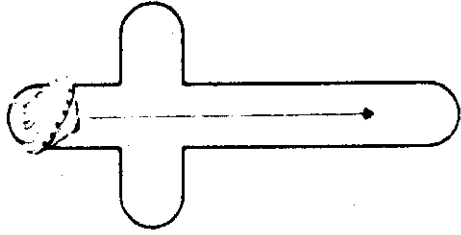

# Letter Tracing

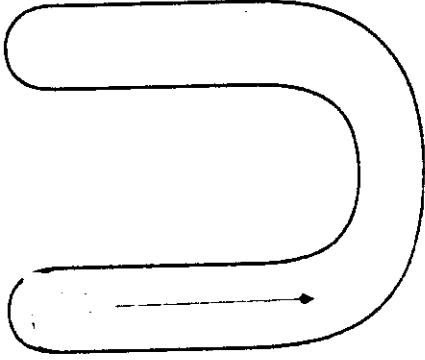
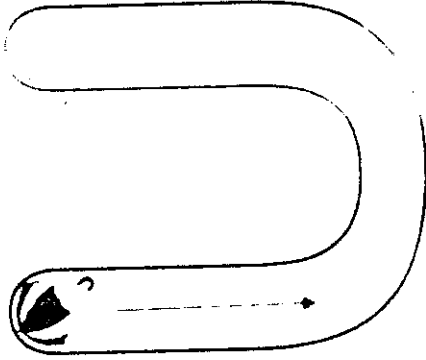
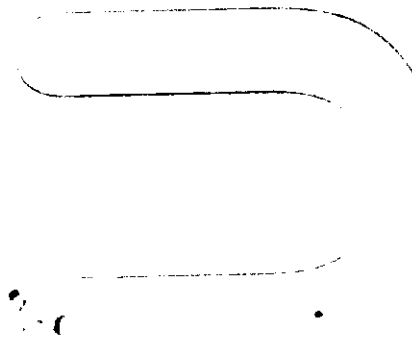
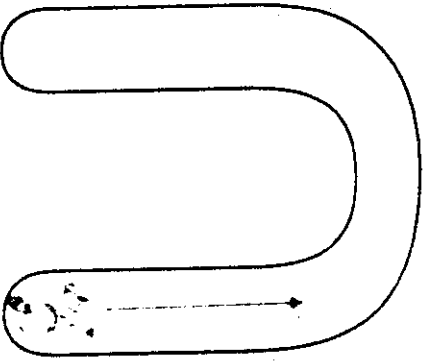
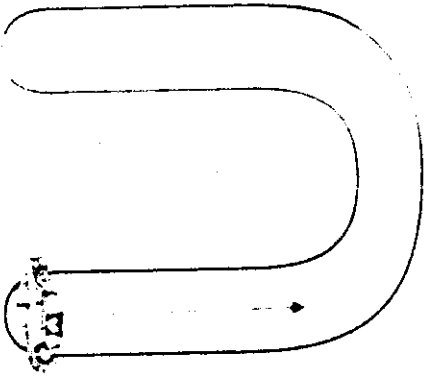
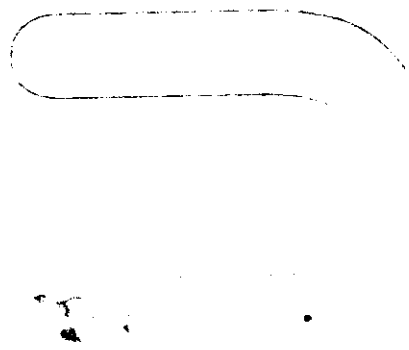

Letter Tracing

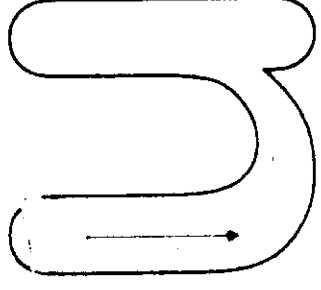
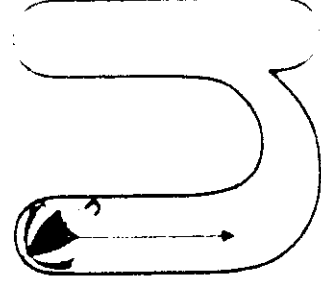
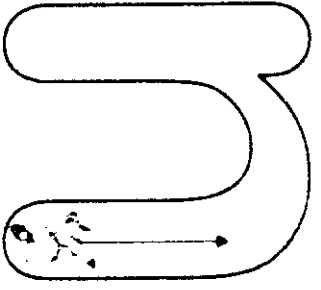
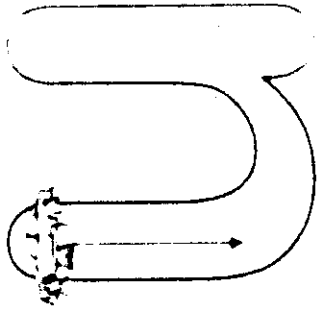
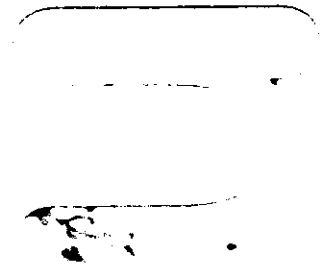

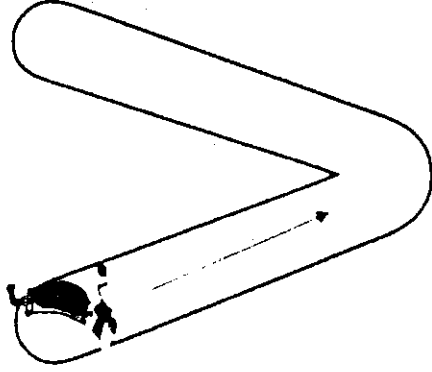
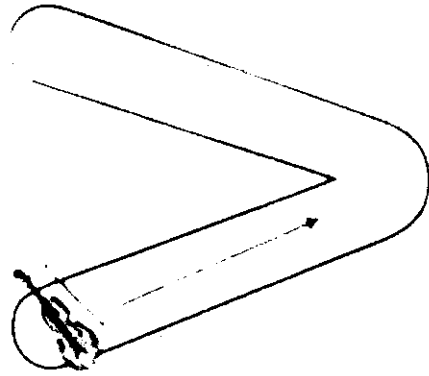
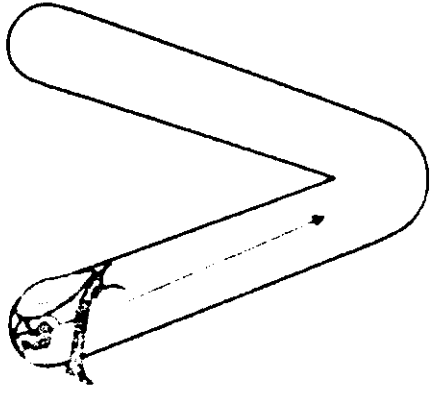
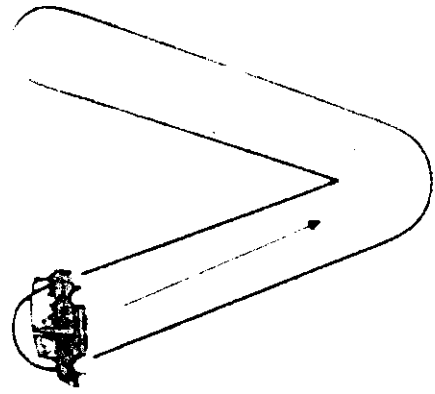

# Letter Tracing



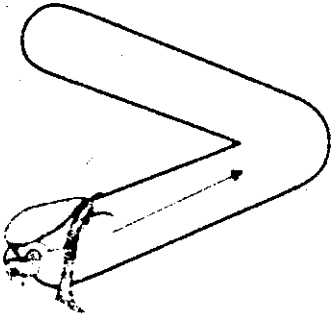
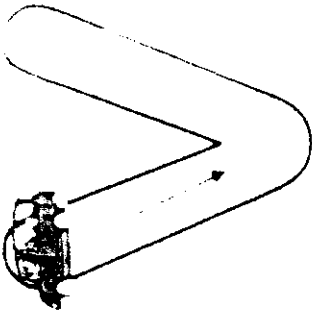
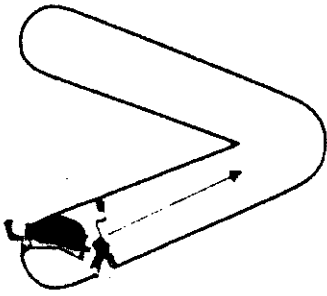

# Letter Tracing

		
		

www.thesecondlanguage.com

# Letter Tracing

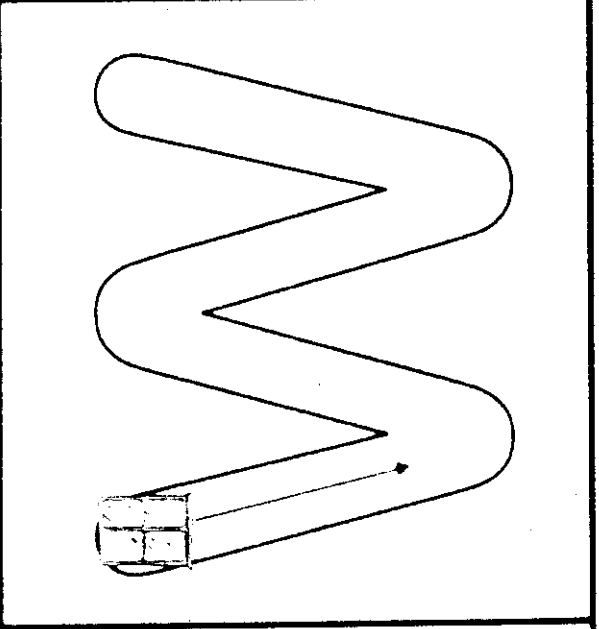
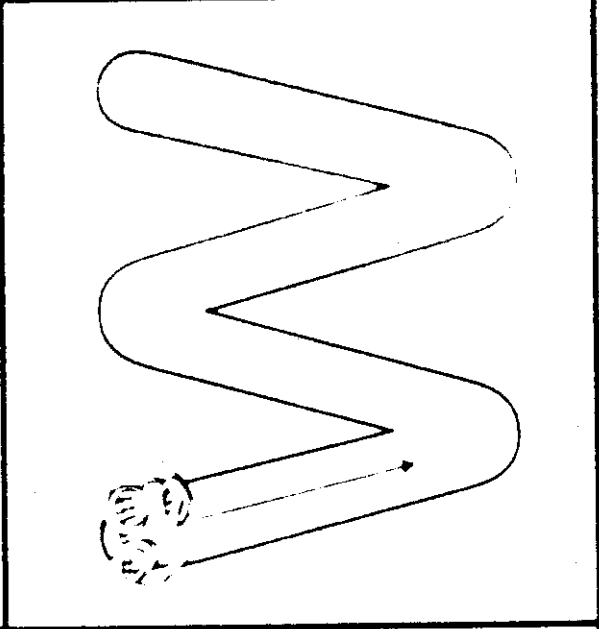
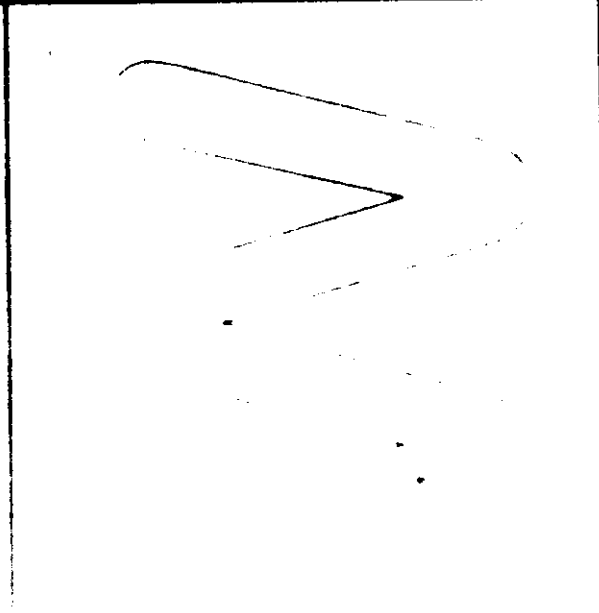
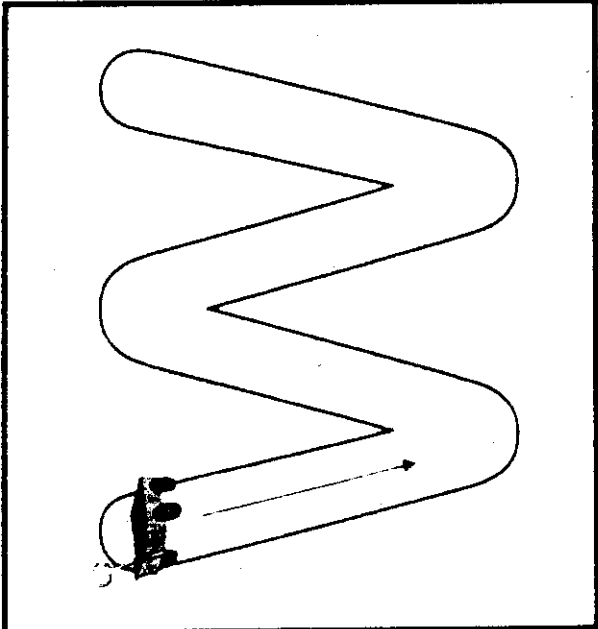
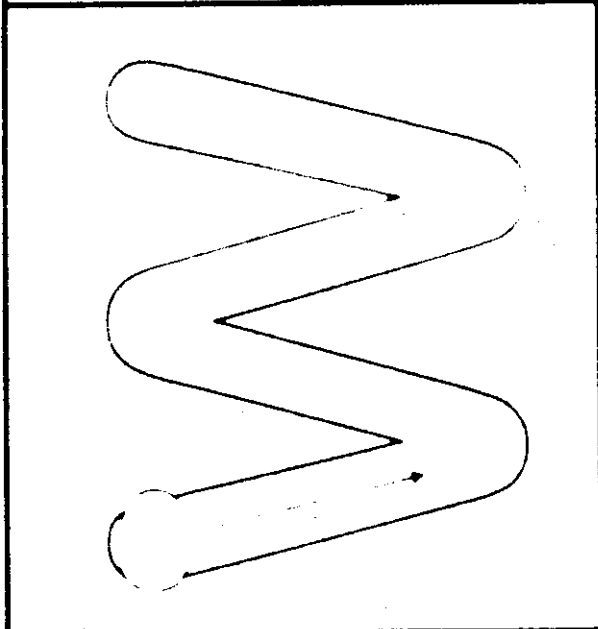
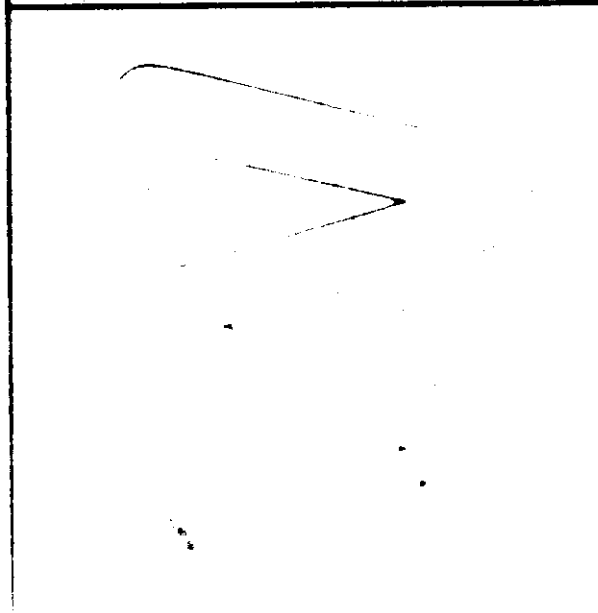

# Letter Tracing

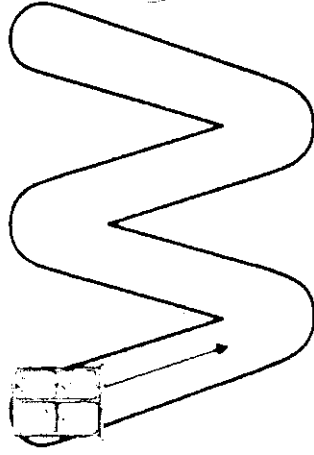
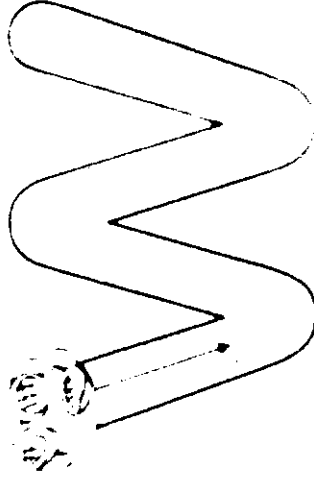
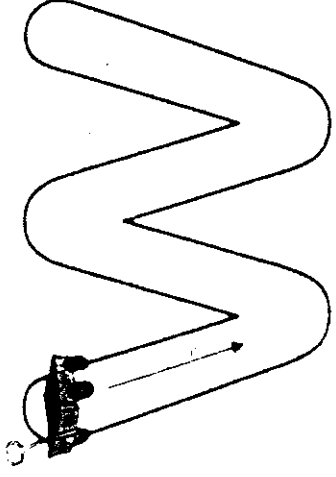
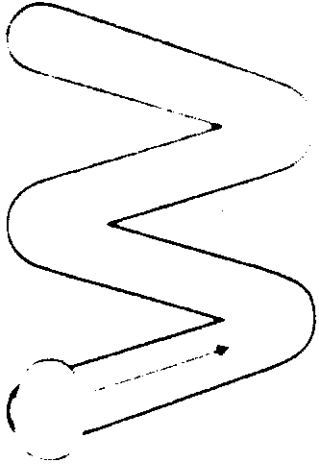

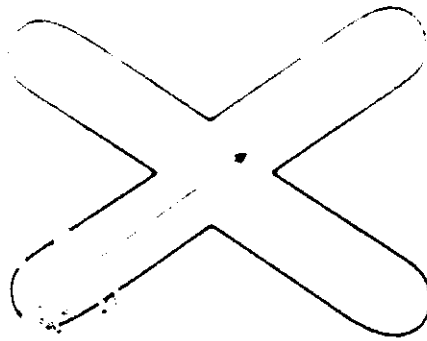
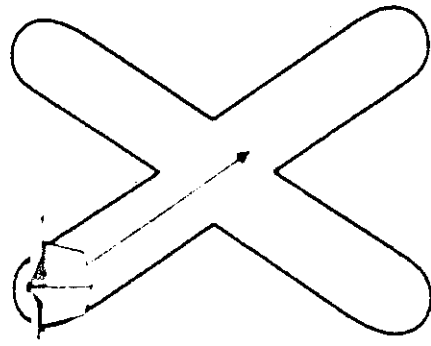
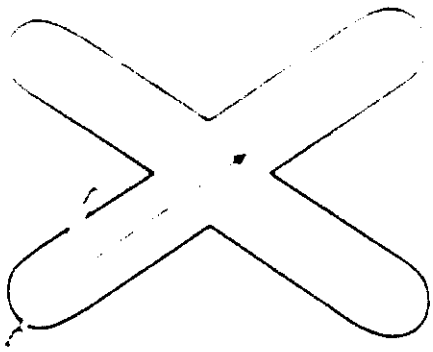
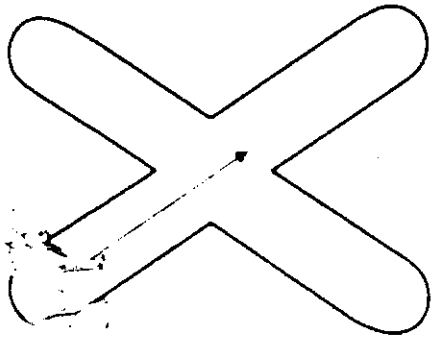

Letter Tracing

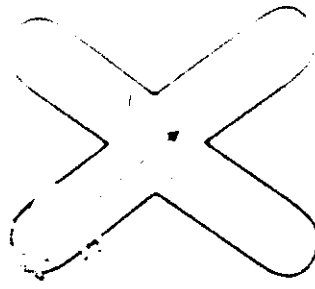
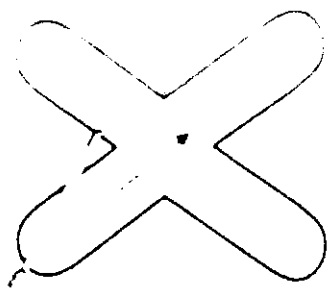
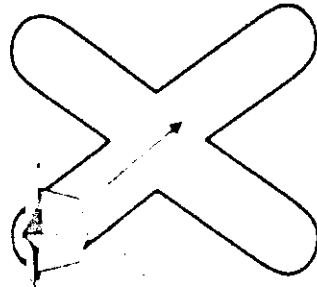
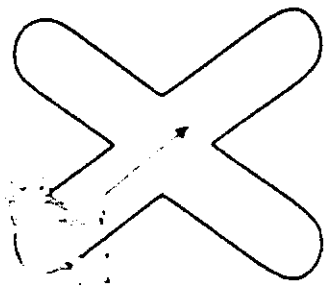

# Letter Tracing

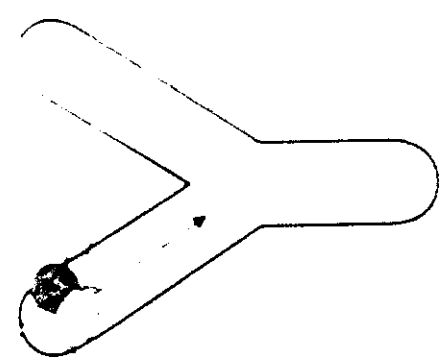
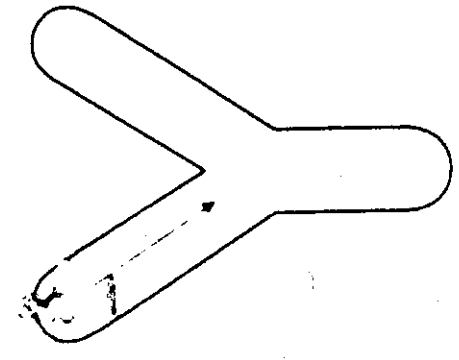

# Letter Tracing

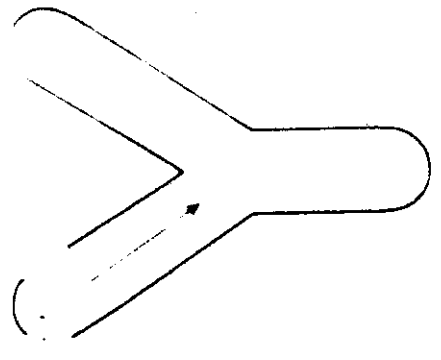
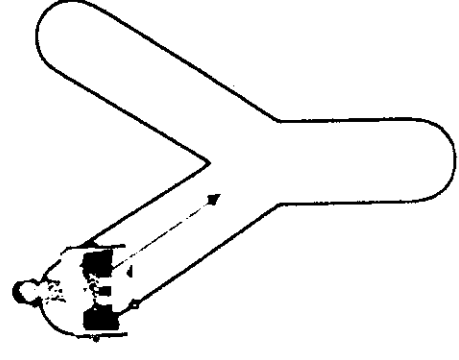
# Letter Tracing

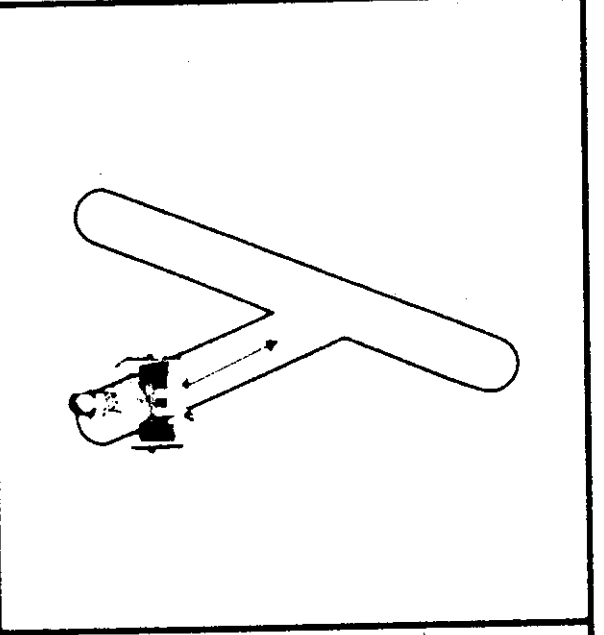
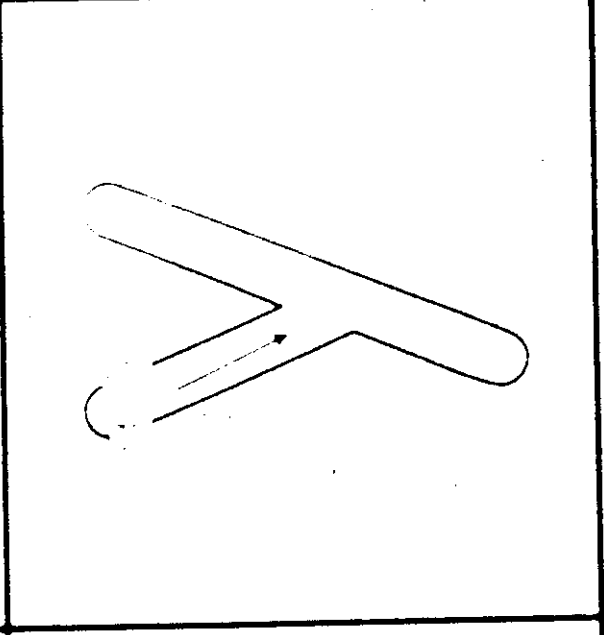
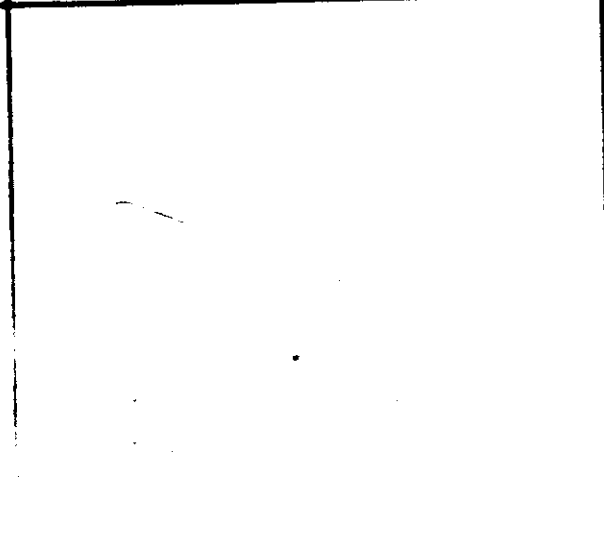
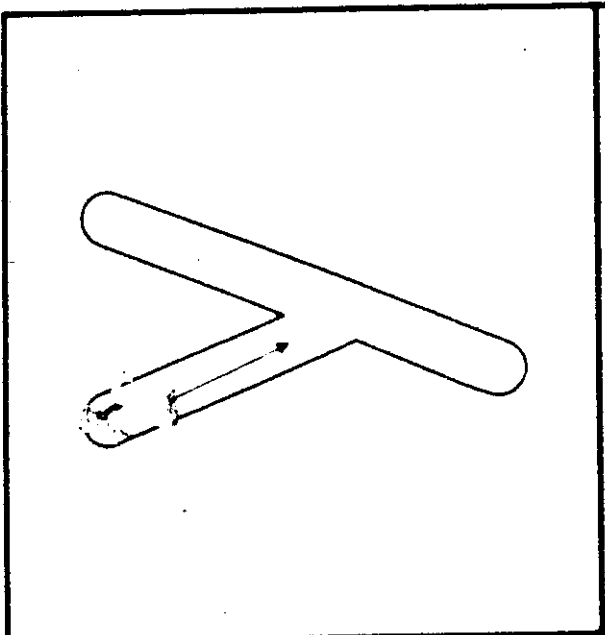
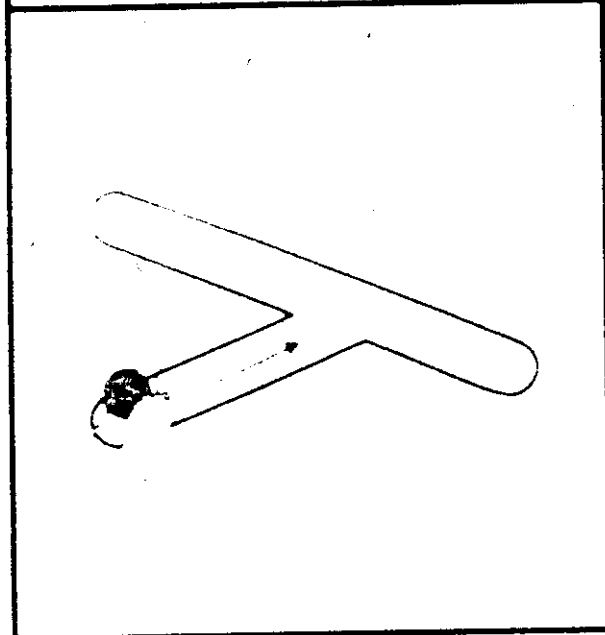
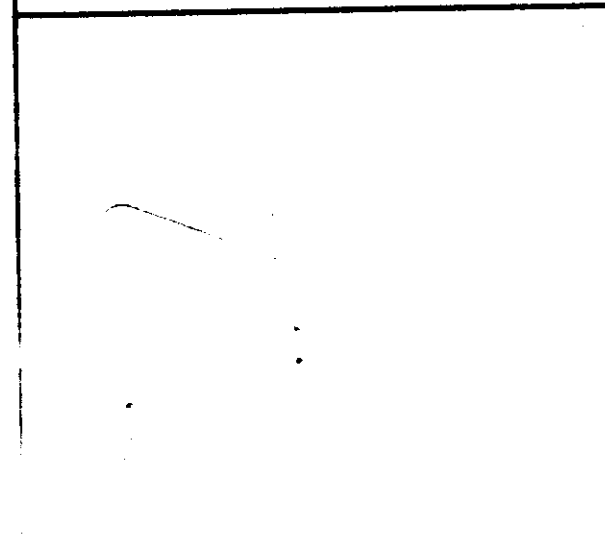

Letter Tracing



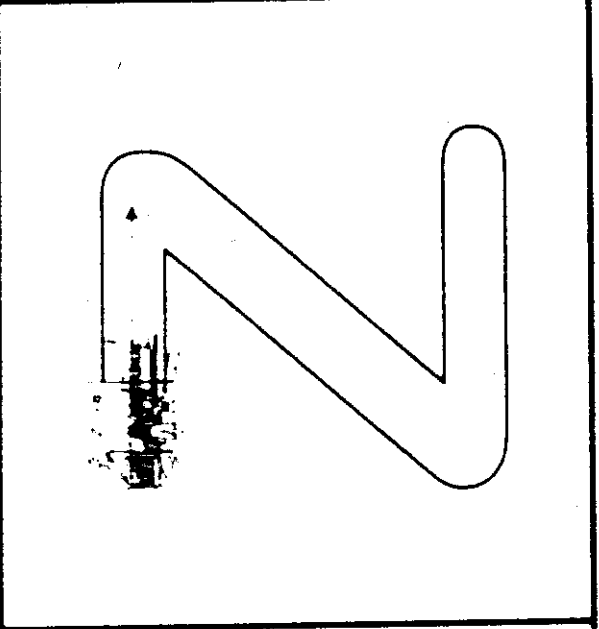
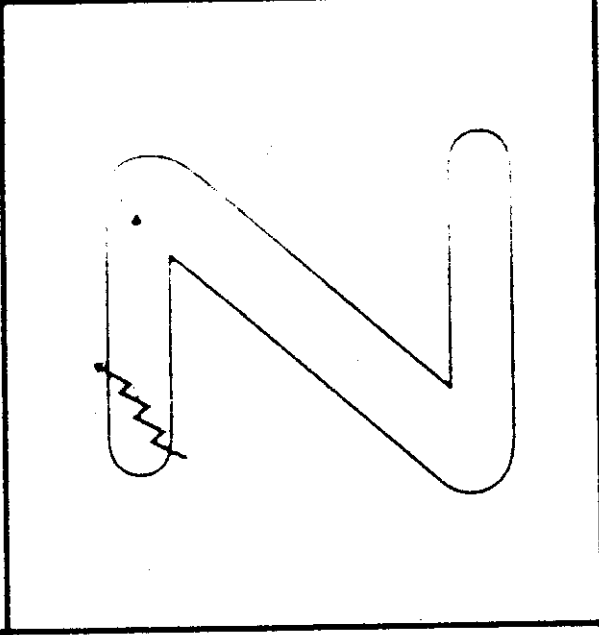
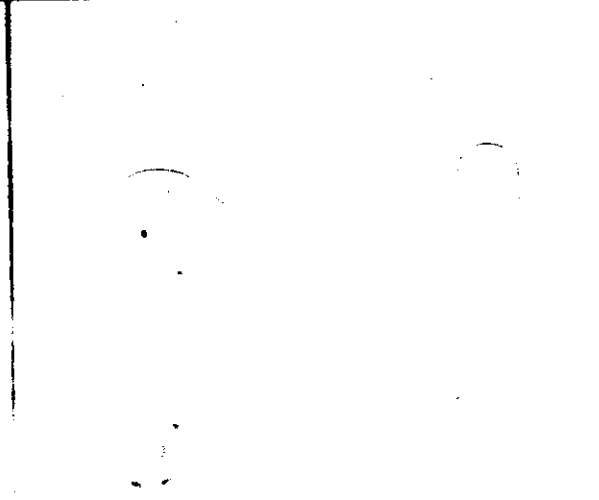
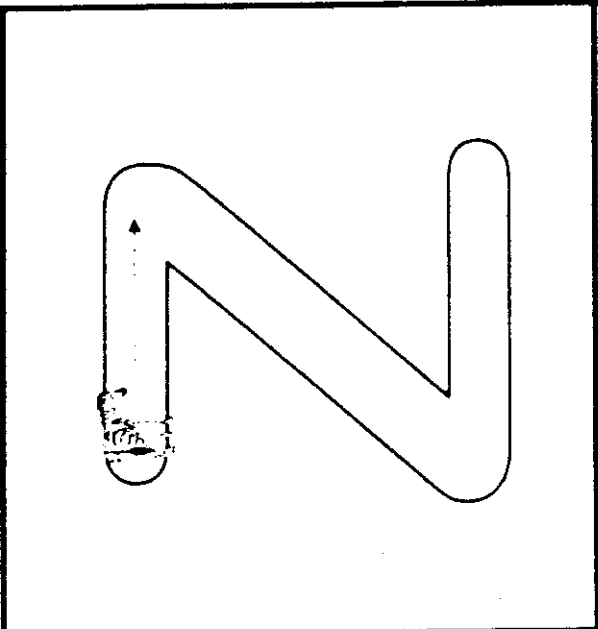
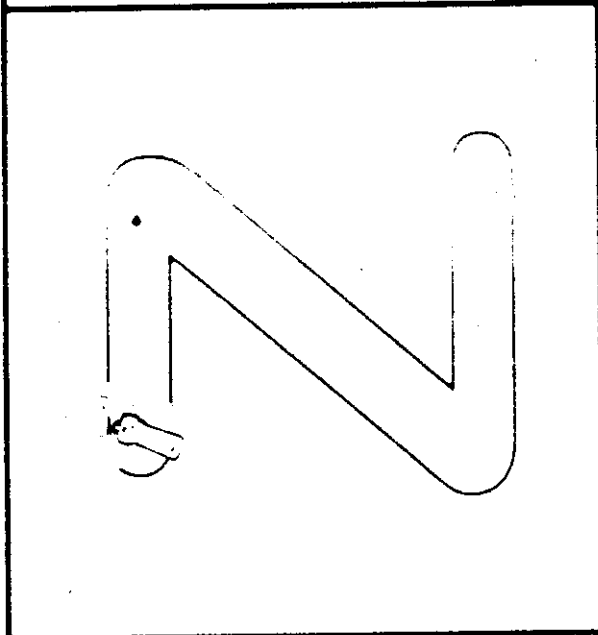
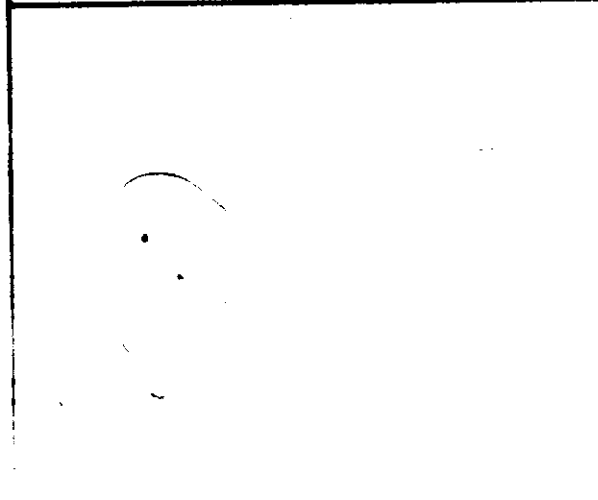

# Letter Tracing

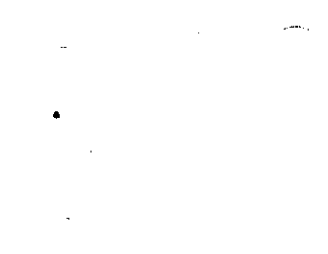
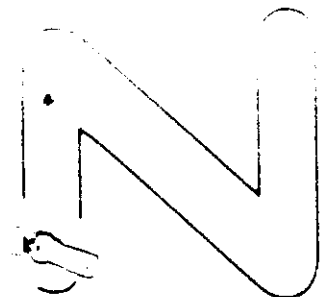
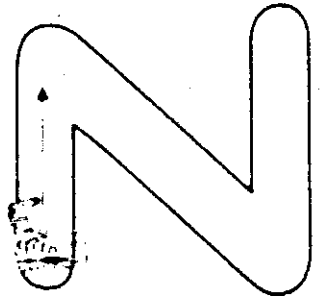
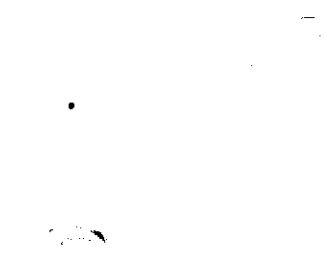
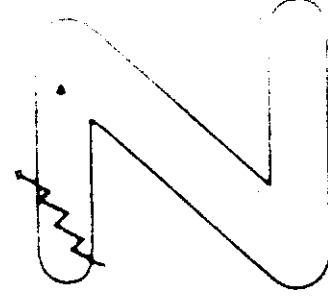
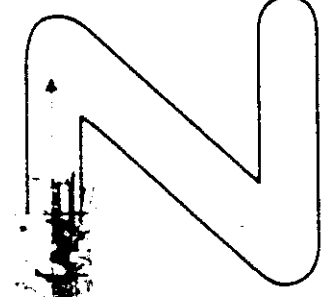
Name: \_\_\_\_\_

# Apple Tracing

Help the caterpillar get to the tasty apple

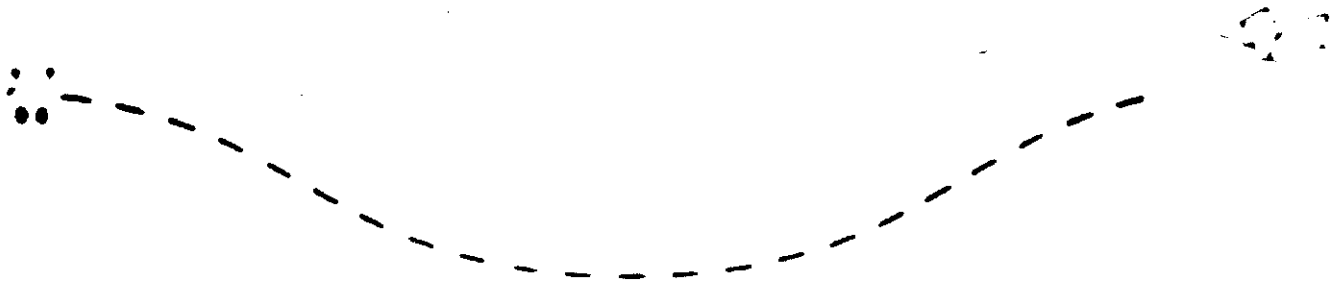
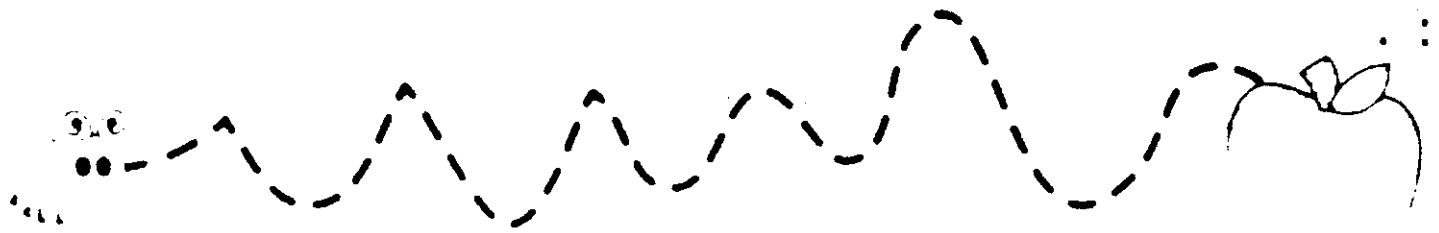
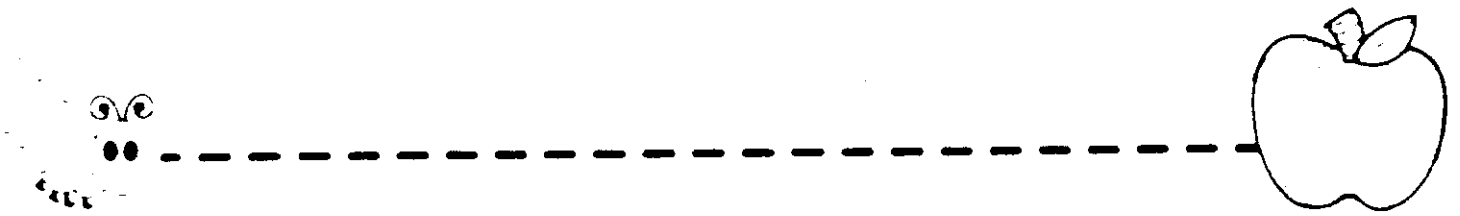

Name \_\_\_\_\_

Color the apples by shape using the key below

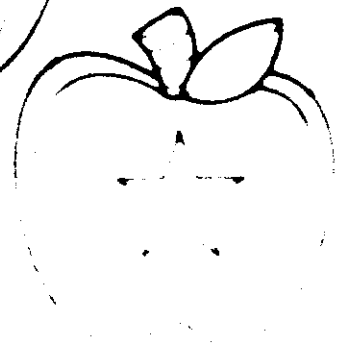
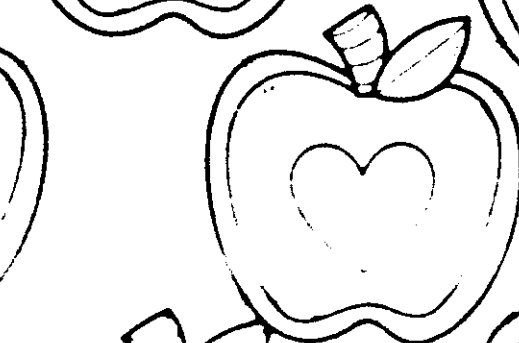
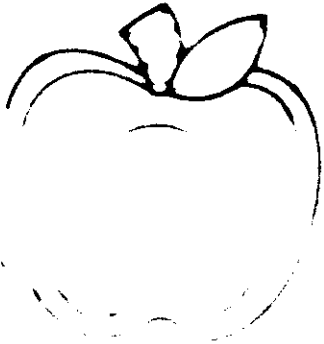
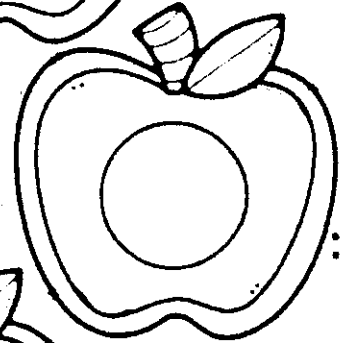
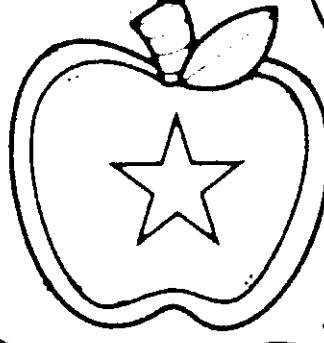
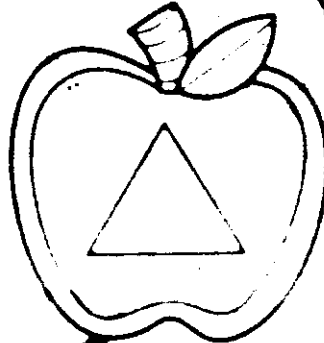
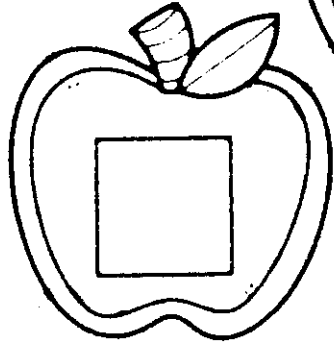
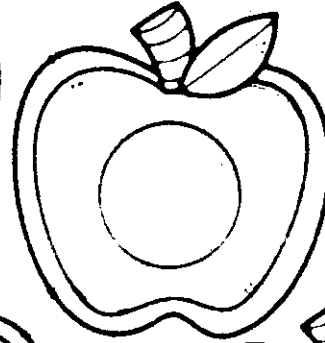
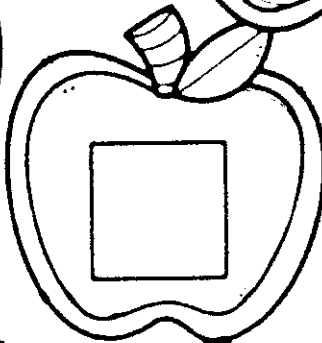
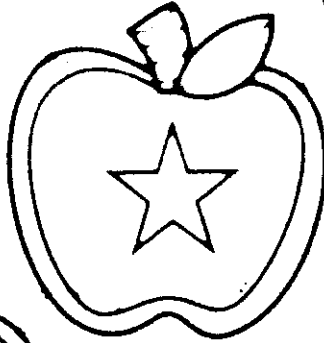
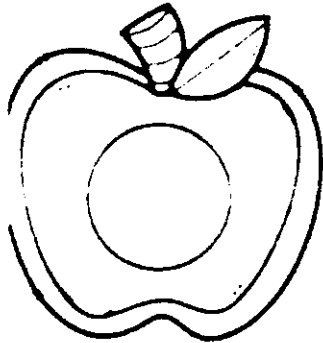
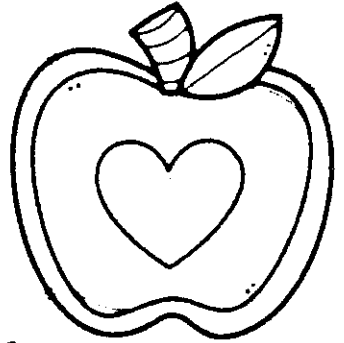
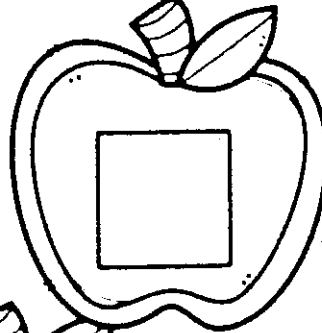
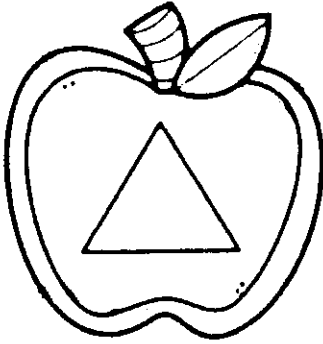
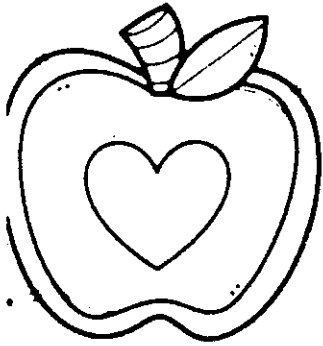
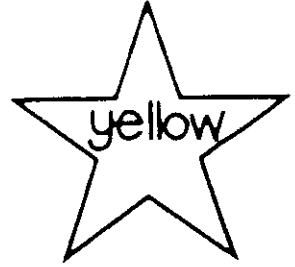
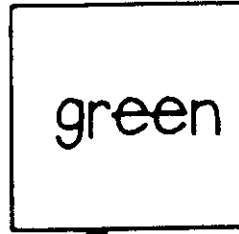
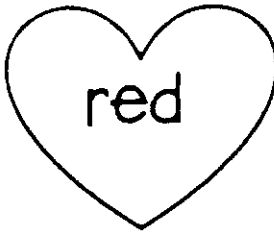
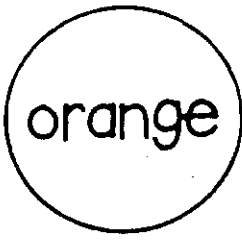
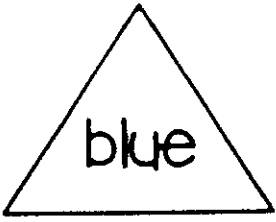

Name: \_\_\_\_\_

Trace the lowercase letters on the apples below

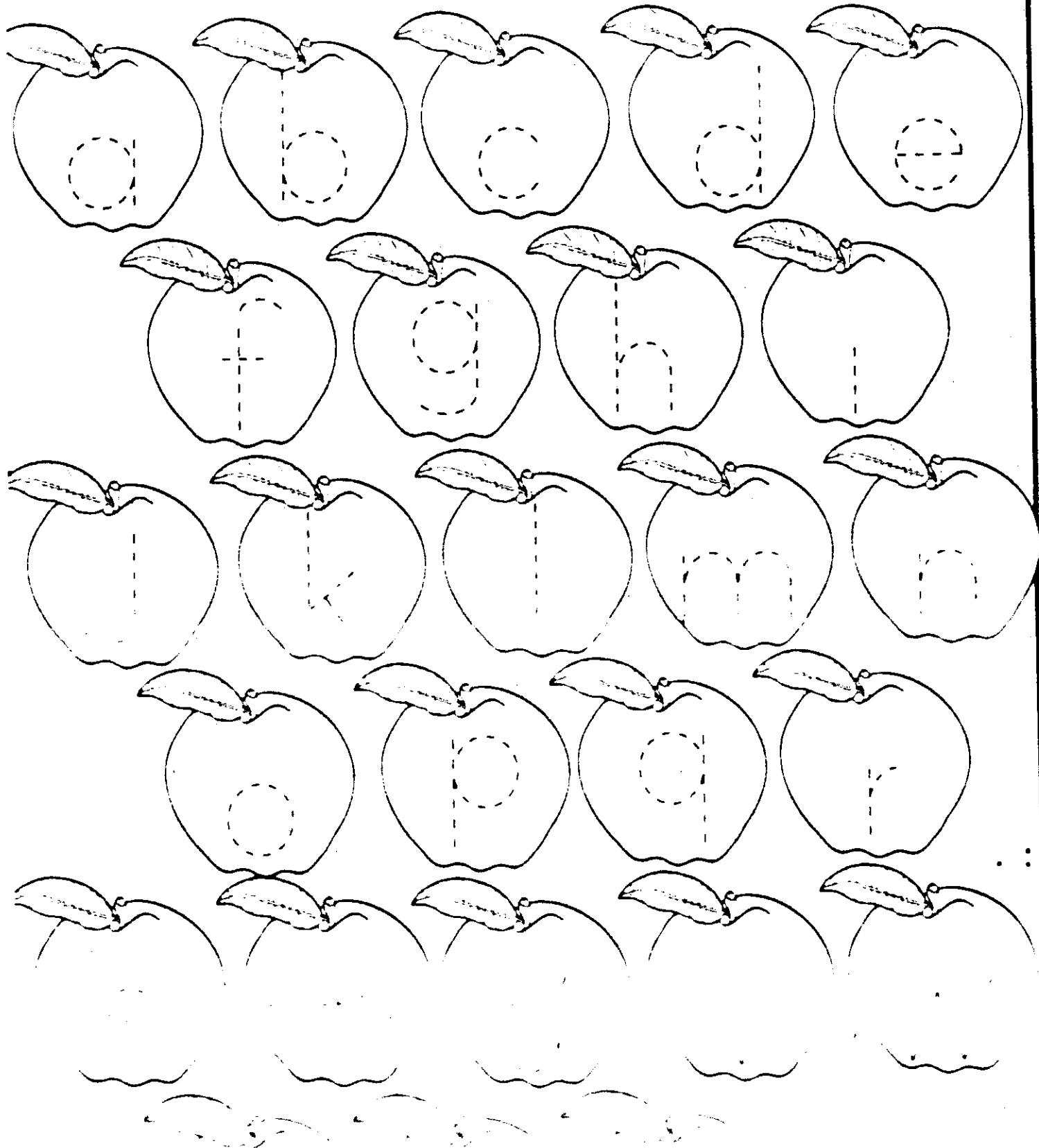

Name \_\_\_\_\_

Trace the uppercase letters on the apples below.

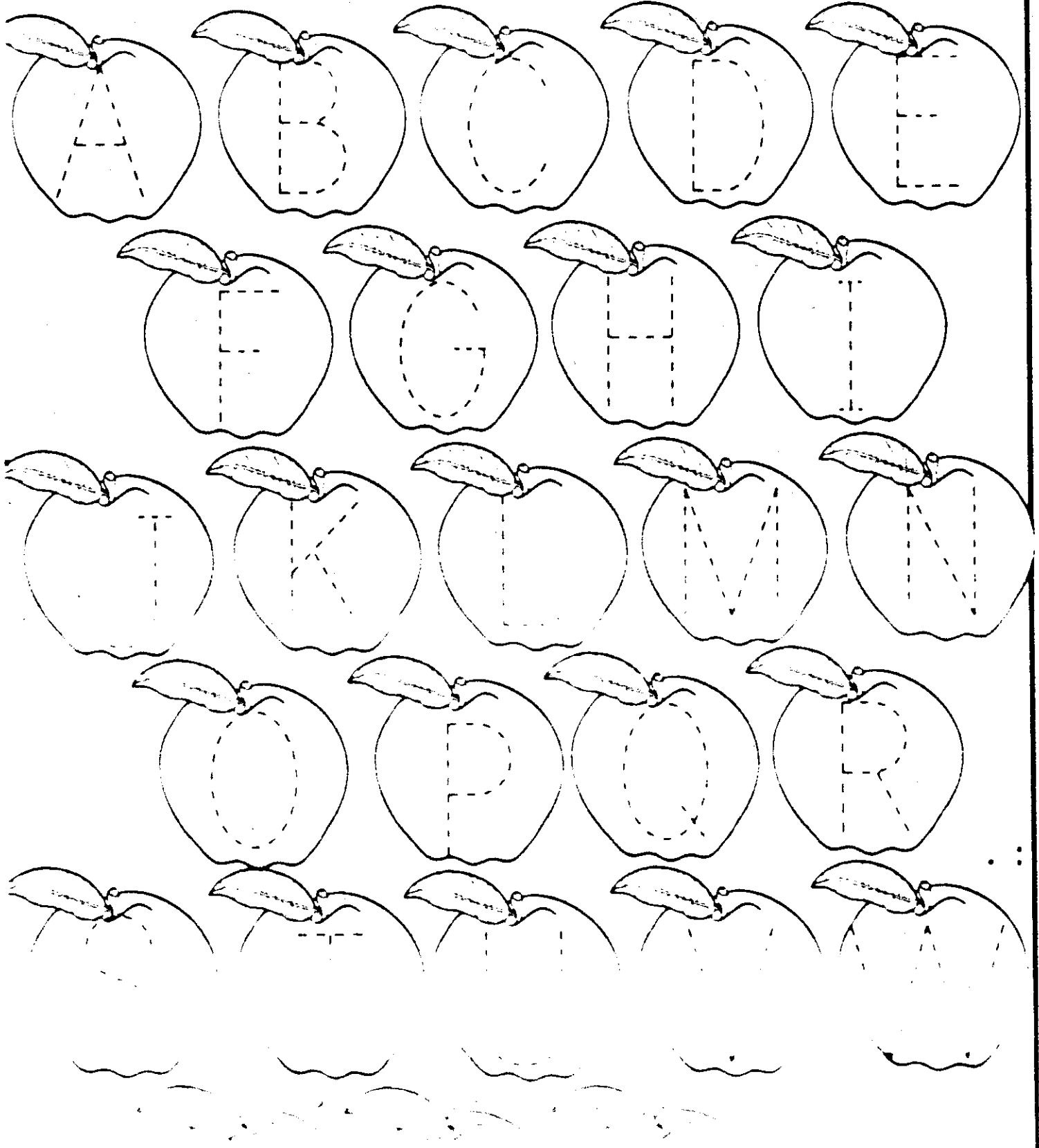

Name \_\_\_\_\_

# Letter or Number

Color the letter apples red and the number apples green.

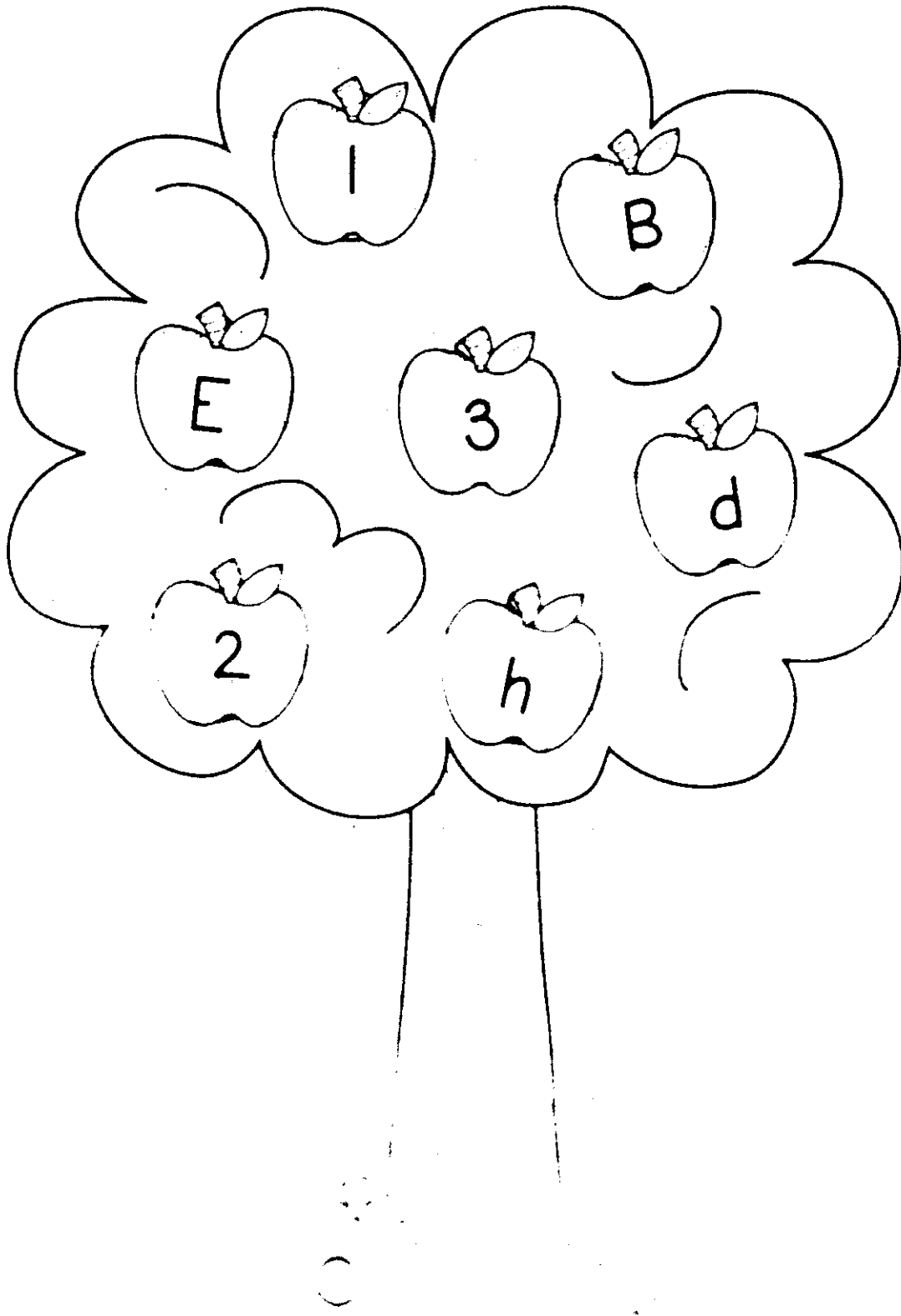

Name \_\_\_\_\_

Count the apple seeds and trace the number and number words you counted

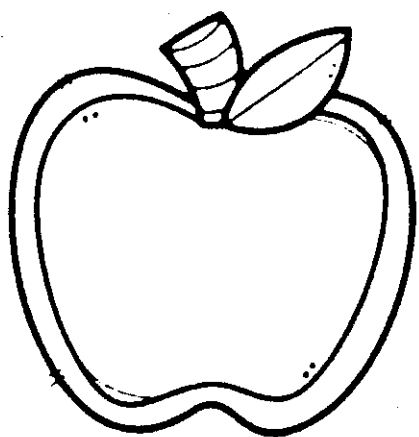

0

zero

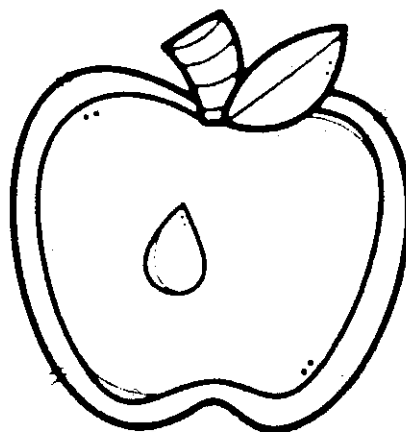

1

one

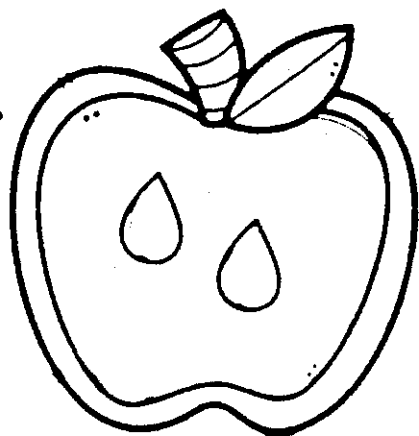

2

two

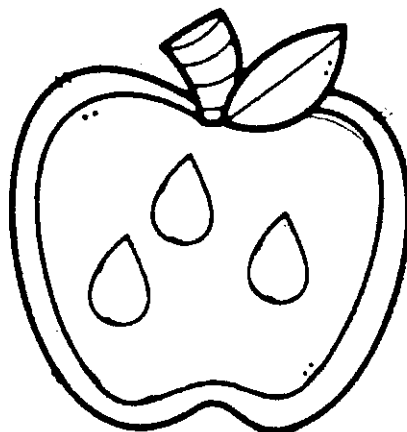

3

three

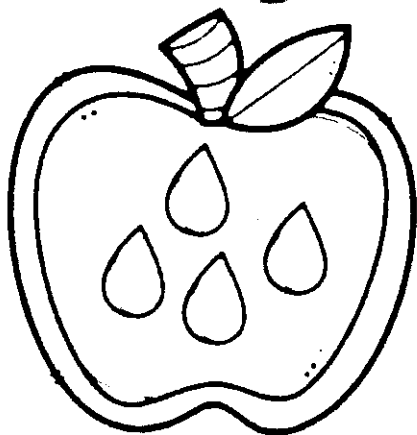

4

four

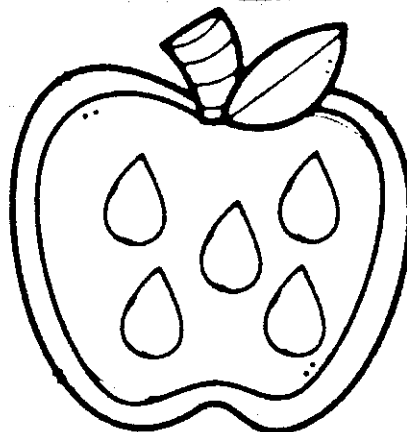

5

five

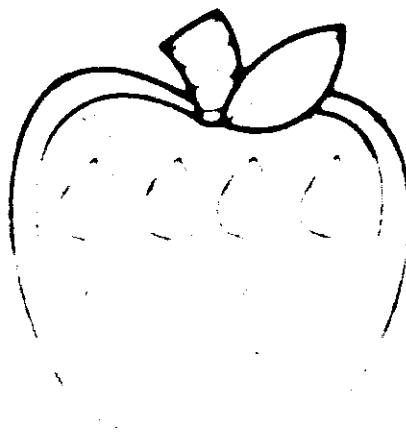
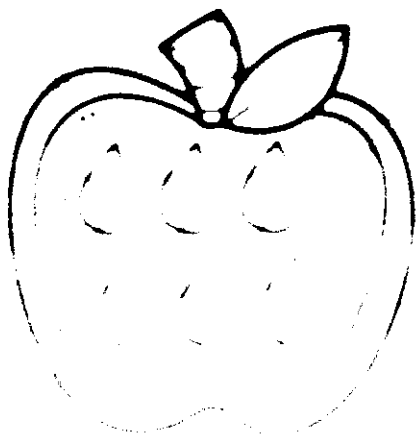

Name \_\_\_\_\_

Count the apple seeds and trace the number and number words you counted

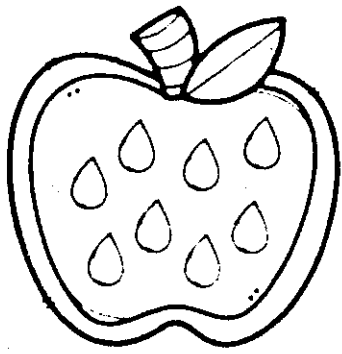

8  
eight

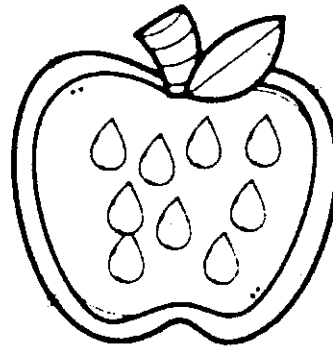

9  
nine

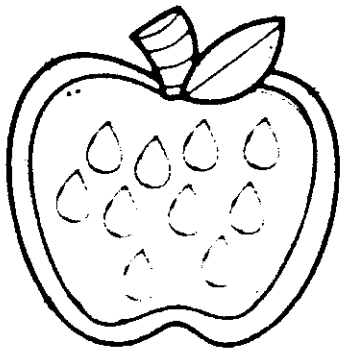

10  
ten

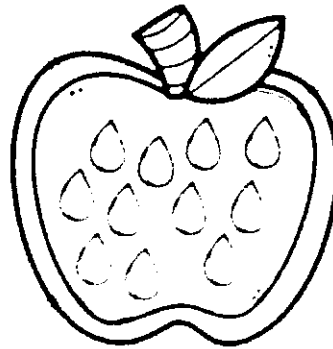

11  
eleven

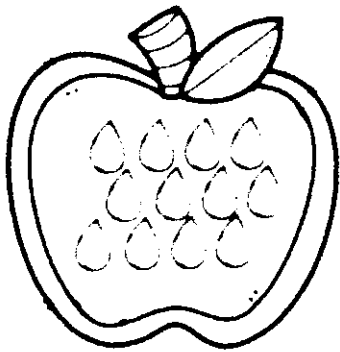

12  
twelve

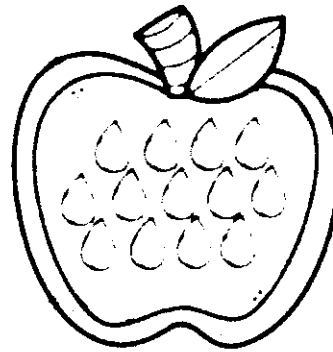

13  
thirteen

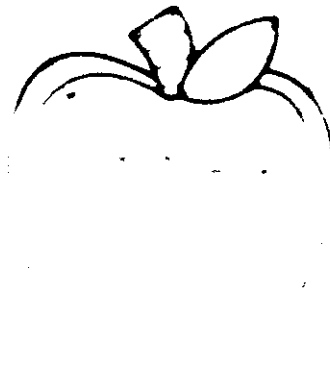
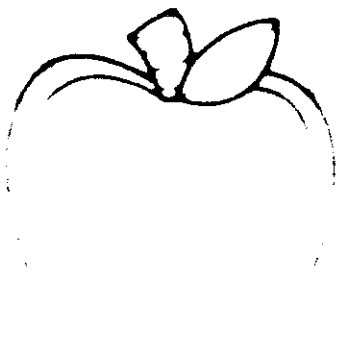



Name \_\_\_\_\_

Color the different looking apples below the color indicated

