

*Request for Proposals (RFP)  
For the*

***Gadsden County School District's***

***DOOR REPLACEMENT PROJECT  
Greensboro Elementary School***



Located at  
1210 Kemp Rd., Havana, FL 32333,  
Gadsden County Florida

**Date Issued: 5/7/2021**

**Date Due: 6/7/2021**

**RFP Number: 2021-0003**

**GCS's Purchasing Department Attn: Andrea Lawson**

35 Martin Luther King Jr. Blvd., Quincy

Office: (850) 627-9651 ext. 1287 , E-mail: [lawsona@gcpsmail.com](mailto:lawsona@gcpsmail.com)

## ADVERTISEMENT

**The Gadsden County School Board**

**Is seeking qualified Door and Hardware Contractors to provide full, turnkey service for the following: The Greensboro Elementary School door replacement project.**

The purpose of this solicitation is to establish a contract with a qualified Door & Hardware Contractor to provide DOOR AND HARDWARE REPLACEMENT AS SPECIFIED IN THE PROJECT DOCUMENTS. The project includes the removal of old and the installation of new doors and associated hardware for a complete turnkey job.

Proposers must meet the following minimum qualifications to be considered:

1. A clear understanding of requested services
2. A minimum of 5 years in business in good standing with DBPR and BBB
3. Properly insured
4. Bondable
5. Bid Bonds are required on all projects \$25,000 and over

A bid package containing the Project Documents may be picked up at the Walker Administration Building located at 35 Martin Luther King Jr. Blvd., Quincy FL or an electronic copy by e-mailing [lawsona@gcpsmail.com](mailto:lawsona@gcpsmail.com). Participants must thoroughly familiarize themselves with all instructions in the bid package to be responsive.

Proposals must be delivered to the Gadsden County School's Purchasing office located at 35 Martin Luther King Jr. Blvd., Walker Administration Building, by **1:45 pm**, on **6/7/2021**. Proposal will be opened on **6/7/2021** at **2:00 pm** in the Walker Administration Building located at 35 Martin Luther King Jr. Blvd., Quincy, FL 32351

---

**Please direct all questions by e-mail to:** Andrea Lawson, E-mail: [lawsona@gcpsmail.com](mailto:lawsona@gcpsmail.com)

Any person with a disability requiring special accommodations at the pre-bid conference and/or bid/proposal opening shall contact Purchasing at the phone number above at least five (5) working days prior to the event. If you are hearing or speech impaired, please contact the Purchasing office by using the Florida Relay Services, phone number 1 (800) 955-8771 (TTY).

## SCHEDULE OF EVENTS

**Summary:** A schedule of events shall be established that will govern all action items related to the competitive solicitation process. This schedule shall be strictly maintained.

Failure by any proposer to meet the event schedule will disqualify that proposer from participating in this RFP but does not disqualify that Proposer from participation in other RFPs.

### Schedule of Events

Description	Date	Time
Public posting	<u>5/7/2021</u>	<u>8:00 am</u>
Last day for written inquiries	<u>5/21/2021</u>	<u>4:00 pm</u>
Anticipated answers to questions	<u>5/26/2021</u>	<u>5:00 pm</u>
Proposal due date	<u>6/7/2021</u>	<u>1:45 pm</u>
Proposal opening	<u>6/7/2021</u>	<u>2:00 pm</u>
Anticipated start of evaluation	<u>6/7/2021</u>	<u>2:00 pm</u>
Anticipated recommendations to the Board	<u>6/22/2021</u>	<u>6:00 pm</u>

Site visits may be scheduled through the Maintenance office by calling (850) 627-9888.

Recommendation will be made to the Board, providing the proposals have been submitted in accordance with the requirements of this RFP document.

## INSTRUCTIONS TO PROPOSERS

### PART 1 – GENERAL CONDITIONS

- 1.1 All Correspondence, communication, and all informational exchanges shall be coordinated through GCPS' Purchasing office. Follow all instructions listed. Failure to do so could result in disqualification.
- 1.2 **Nonacademic Purchases:** The Gadsden County School Board, prior to the release of this RFP, has reviewed the purchasing agreements and state term contracts to determine whether it is in the school board's economic advantage to use the agreements and contracts. *F.S. 1010.04*
- 1.3 **Vendor Registration:** All individuals or firms wishing to do business with The Gadsden County School District, whether a Consultant, Contractor, Subcontractor or Material provider, must register as a Vendor prior to submitting a Bid or Proposal. A Vendor ID No. is mandatory for receiving a PO.
  - A. If you are not a registered GCPS vendor, you will need to complete the W-9 form and return it to GCPS Purchasing office.
  - B. If you previously registered as a vendor and received your vendor ID number there is no need to re-submit, just reference your number on the Bid Form.
- 1.4 **Proposer Registration:** In addition to the Vendor Registration, proposers must register with GCPS Purchasing Office in order to be placed on the mailing list for any forthcoming addenda or official communications. GCPS shall not be responsible for providing addendums to proposers that are not registered.
  - A. Failure to register as a prospective proposer may cause your proposal to be rejected if you have submitted without the most current addendum.
- 1.5 All purchases for services or commodities \$25,000.00 or more, whether a onetime purchase or an accumulation of like items, are required to be handled through a competitive bid, unless specifically exempt as indicated in DOE Rules and Regulations or Board Policy.
  - A. Competitive bids are mailed, emailed or delivered in a sealed envelope. The specified due date and time shall be strictly followed.
- 1.6 **Subcontracting:** Where a proposer utilizes subcontracts in the performance of the Work the names of the subcontractors must be submitted to the District for approval prior to the first payment.
- 1.7 **Site Visits:** shall be scheduled by the owner to hours during which disruption of normal activities are minimized.
  - A. All proposers will check in with the Facilities Office before arriving at any of GCPS sites.
  - B. Visitors shall be escorted by Facility staff or their representative. At no time are they allowed to enter school property without authorization and checking in.

- C. **Contact, communication, videotaping or photographs of students or other staff is strictly prohibited.**
  - D. Proper decorum and behavior appropriate to an educational facility is mandatory. Disruption of educational activities will not be tolerated.
  - E. District personnel are not authorized to interpret, clarify, or modify the RFP in any way.
    - 1. All interpretations, clarifications, or modifications shall be by mean of an addendum issued from GCPS purchasing department.
- 1.8 **Existing Conditions:** Failure of Proposer to acquaint itself with any applicable condition will not relieve it from the responsibility for properly estimating either the duration, difficulties, or the costs of successfully providing the services.
- 1.9 **Proposal Representation:** By submitting a proposal the Proposer represents that it has:
- A. Examined all Documents thoroughly.
  - B. Visited the site(s) to familiarize themselves with local conditions that may in any manner affect cost, progress, or performance in providing the services.
  - C. Familiarized themselves with federal, state, and local laws, ordinances, rules, and regulations that may in any manner affect cost, progress or performance of the service.
- 1.10 **Interpretations:** All questions about the meaning or intent of the RFP shall be submitted only through GCPS Purchasing Office who will log and forward for written clarifications.
- A. All answers will be by addenda. Only questions answered by formal written Addenda issued by GCPS Purchasing Office will be binding. Oral and other interpretations or clarifications will be without legal effect.
  - B. Any items, materials, conditions, services, etc.... that may be alluded to in any documentation and that is not clearly understood by the proposer as to the Owner's intent, shall be clarified by the proposer prior to submitting. Failure to clarify any ambiguity shall not relieve the proposer from supplying the intent of the Owner as part of the base contract.
- 1.11 **Revisions and Amendments to the RFP:** The Owner reserves the right to revise or amend the RFP prior to the opening date. Such revisions and amendments, if any, will be announced by an addendum. The date set for the opening of the RFP may be postponed by as many days as the Owner deems adequate to estimate material and cost changes. In such cases the addendum will include an announcement of the new RFP opening date. The proposers shall acknowledge receipt of all addenda by signing, dating, and returning the acknowledgment page of the addendum with their proposal.
- 1.12 **Bonds and Insurance:** Insurance is required for all projects with the District. Bonding is required on larger projects as specified.

- A. **Bid Bonds:** The Gadsden County School Board policy requires a Bid Bond of 10% on all projects \$25,000 and up.
- B. **Performance and Payment Bonds:** Any person entering into a formal contract with the Gadsden County School Board, for construction or repairs shall be required, before commencing the work, to execute and record in the public records of the county where the Work is located, a payment and performance bond with a surety company authorized to do business in Florida. *F.S. 255.05*.
1. For Work \$100,000 and above, a payment and performance bond shall be required unless specified otherwise.
  2. Evidence of bonding capability for the following major subcontractors may be required to be included with the Bid:
    - a. Mechanical
    - b. Electrical
    - c. Plumbing
    - d. Roofing
    - e. Shell and Concrete
  3. For the "Performance Bond and Payment Bond", (AIA) Document A312, March 1987 Edition shall be used.
  4. **When Bonds are required, a statement from a qualified Surety company giving evidence of bonding capability at 100% of the Contract Amount being bid, must accompany all project proposals or Sub-Contractor bids.**
  5. The respective performance and payment bonds shall:
    - a. Require the Surety to perform the Subcontract and to pay all bills and invoices for labor done and materials provided in the performance of the Work, including any guarantee or warranty period provided for in the Contract Documents.
    - b. In case of default or other proceedings on the part of the Subcontractor, actions for all expenses incident to ascertaining and collecting losses under the bond, including reasonable attorney's fees for same, shall be covered by the bond.
- C. **Insurance:** Evidence of current insurance or the ability to retain adequate insurance must accompany all bids and proposals. Before providing any services the Contractor, at its own expense, shall obtain for itself and its personnel and will maintain the following insurance coverage throughout the term of this Agreement. Certificates of Insurance acceptable to the Owner shall be filed with the Owner prior to commencement of the Work.
1. **Workers' Compensation:** The Contractor and all Sub-Contractors must include proof of current Workers' Compensation insurance with their Proposal or Bid. Such proof of insurance must be evidenced by a certificate of coverage issued by the carrier, a valid exemption certificate approved by the department

of Financial Services or a copy of the employer's authority to self-insure. *F.S. 440 and 489.114.*

- a. All Contractors and Subcontractors shall maintain valid Workers' Compensation Insurance throughout the project as required by *F.S. 440.*

2. **Liability Insurance:** Comprehensive general liability insurance coverage (including, but not limited to, contractor's commercial liability coverage and automobile liability coverage for vehicles) for services, Work, and construction contemplated under this Agreement, for limits not less than \$1 million per occurrence.

- a. The Owner shall be exempt from and in no way liable for any sums of money which may represent a deductible in any insurance policy. The payment of such deductible shall be the responsibility solely of the Contractor and/or Subcontractor providing such insurance.

- 1.13 **Familiarity with Laws:** The proposer shall be familiar with and perform work in accordance with all Federal, State and Local laws, ordinances, rules and regulations affecting the work. Ignorance of them on the part of the Proposer shall in no way relieve it from responsibility.

- 1.14 **Florida Product and Labor:** *Section 255.04 F.S.* requires that on public building contracts, Florida products and labor shall be used when price and quality are equal to out of state submissions.

- 1.15 **Taxes and Assessments:** Although the Owner is not subject to the Florida Sales Tax, any contractor who purchases materials which will be used in the construction of a public works facility **will not** be exempt from the sales tax on those materials. *Section 192 F.S.*

- A. The owner is exempt from all Federal excise taxes on materials, appliances, etc., which are incorporated into and become a part of the finished improvements.

- 1.16 **Public Entity Crimes:** A person or affiliate who has been placed on the convicted vendor list following a conviction for a public entity crime may not submit a bid on a contract to provide any goods or services to a public entity, may not submit a bid on a contract with a public entity for the construction or repair of a public building or public work, may not submit bids on leases or real property to a public entity, may not be awarded or perform work as a contractor, supplier, subcontractor, or consultant under a contract with any public entity, and may not transact business with any public entity in excess of the threshold amount provided in *section 287.017 F.S.* for CATEGORY TWO for a period of 36 months from the date of being placed in the convicted vendor list.

- A. The Bidder shall complete and submit with their bid, a Public Entity Crime Statement Form, 04103, provided herein.

- 1.17 **Background Screening:** As required by the Jessica Lunsford Act [s.21 of Ch.2005-28, L.O.F.], if any contractor's employees/independent contractors or subcontractors, employees/independent contractor will have access to school grounds when students are present, have direct contact with students, or have access to our control of school funds, such personnel are required to be screened at Level 2, to include fingerprints, statewide criminal and juvenile justice records checks through the Florida Department of Law

Enforcement and federal criminal records checks through the Federal Bureau of Investigation. [s.1012.465, Florida Statutes] The requirements of this law must be met in order for the GCPS to contract with your company. By responding to this Invitation to Bid, you agree to abide by all GCPS policies and procedures in regards to Florida Statutes sections 1012.315, 1012.32, 1012.465 **The Jessica Lunsford Act**, 1012.467 and 1012.468. There is a fingerprinting fee associated with these procedures. Refer to the School Board website (<http://www.gcps.k12.fl.us/>), Jessica Lunsford Act. This web site is updated as policies and procedures are put into place. The Vendor/Contractor will bear the cost of acquiring the background screening required and any/all fees imposed by the Florida Department of Law Enforcement and or the District to maintain the fingerprints provided with respect to vendor/contractor and its employees. Contractor agrees to indemnify and hold harmless the School Board, its officers, agents and employees from any liability in the form of physical injury, death, or property damage resulting from the Contractor's failure to comply with the requirements of these cited policies and statutes. The vendor/contractor will follow procedures for obtaining employees background screening as established by the School Board of Gadsden County.

**Where:** School Board of Gadsden County – Walker Administration Building  
35 Martin Luther King, Jr., Blvd. Quincy, Florida 32351

**When:** Monday – Friday 8:00 a.m. – 4:00 p.m. Call for an appointment

**Contact:** Human Resources Department @ 850-627-9651

- 1.18 **Drug Free Workplace:** The Gadsden County School District is a drug free workplace. Proposers shall include with their proposal, a Drug Free Workplace declaration found in this document. Exclusion of the declaration may be used as a tiebreaker.
- 1.19 **Verification of Employment:** In accordance with State of Florida Office of the Governor Executive Order Number 11-02, the firm shall utilize the U.S. Department of Homeland Security's E-Verify system to verify the employment eligibility of all persons employed during the contract term by the firm to perform employment duties within Florida and all persons (including sub-consultants) assigned by the firm to perform work pursuant to the contract with Gadsden County School Board.
- 1.20 **Reciprocity of Florida School I.D. Badges:** If Vendor/Contractor has a Level 2 clearance - State Vendor Badge (good for 5 years) they will need to contact our HR Dept. to check verification by provide a copy of the badge or social security number of the employee(s) needing verification beforehand. There is **no additional cost for verifying the State Vendor Badge. BADGES MUST BE WORN AT ALL TIMES while working for the School Board of Gadsden County.**
- 1.21 **Non-Discrimination:** The Gadsden County School District does not discriminate against any person on the basis of race, color, ethnicity, genetic information, national origin, religion, gender, marital status, disability, or age in programs or activities. *Section 202 of the Office of Federal Contract Compliance Programs (OFCCP) Executive Order 11246 as amended.*
- A. The awarded Contractor and all independent contractors shall comply with Applicable Laws regarding equal employment opportunity. As required, the Contractor and independent contractors agree to both of the following:



1. In the hiring of employees for the performance of work under the contract or any subcontract, no contractor, subcontractor, or any person acting on a contractor's or subcontractor's behalf, by reason of race, creed, sex, disability or military status or color, shall discriminate against.
  2. No contractor, subcontractor, or any person on a contractor's or subcontractor's behalf, in any manner, or color, shall discriminate against or intimidate any employee hired for the performance of work under the contract.
- 1.22 **Federal Debarment Certification:** Certification regarding debarment, suspension, ineligibility and voluntary excluding as required by Executive Order 12549, Debarment and Suspension, and implemented at 34CFR, Part 85, as defined at 34 CFR Part 85, Sections 85-105 and 85-110(ED80-0013).
- A. The prospective lower tier (\$100.00) participate certifies, by submission and signature of this proposal, that neither it nor its principals are presently debarred, suspended, proposed for debarment, declared ineligible, or voluntarily excluded from participation in this transaction by any federal department or agency.
  - B. Where the prospective lower tier participant is unable to certify to any of the statements in this certification, such prospective participant shall attach an explanation to this RFP.
- 1.23 **Conflict of Interest:** The award hereunder is subject to the provisions of *Chapter 112, Florida Statutes*. All proposers must disclose with their proposal the name of any officer, director, or agent who is also an employee of the School District. Further, all proposers must disclose the name of any Board employee who owns, directly or indirectly, an interest of five percent (5%) or more in the proposer's firm or any of its branches.
- 1.24 **Related Party Transactions:** The term "related party" shall mean a parent, subsidiary, affiliate or other entity having common ownership or management with the Contractor; any entity in which any stockholder in, or management employee of, the Contractor owns any interest in; or any person or entity which has the right to control the business or affairs of the Contractor. The term "related party" includes any member of the immediate family of any person identified above.
- A. If any of the costs proposed arise from a transaction between the Contractor and a related party, the Contractor shall notify the Owner of the specific nature of the contemplated transaction, including the identity of the related party and the anticipated cost to be incurred, before any such transaction is consummated or cost incurred.
    1. If the Owner, after such notification, authorizes the proposed transaction, the Contractor shall procure the work, equipment, goods, or service from the related party, as a Subcontractor, according to the terms of this agreement.
    2. If the Owner fails to authorize the transaction, the Contractor shall procure the work, equipment, goods, or service from some person or entity other than a related party according to the terms of this agreement.

- 1.25 **Direct Purchase:** If requested, the proposer shall include in its proposal the cost of any equipment, materials, or labor. GCPS shall be allowed to purchase any number of items it chooses to directly, as allowed by *Section 212.08(6) F.S.* for tax savings. The Contract and Purchase Order, in such case, shall be amended by change order.
- 1.26 **Execution of Proposal:** RFP's must contain an original manual signature of an authorized representative. Failure to properly sign the RFP may invalidate it. **Any illegible entries, pencil proposals, or corrections not initialed may not be considered.** The original conditions and specifications cannot be changed or altered in any way. Altered proposals will not be considered. Clarification of proposals submitted shall be in letterform, signed by the proposer and attached to the RFP.
- 1.27 **Number of Copies:** The proposer shall submit one (1) original complete and signed Package as specified on page two (2).
- 1.28 **Preparation Costs:** GCPS shall not be liable for any expenses incurred in connection with the preparation of a response to this RFP.
- 1.29 **Due Date and Time:** The date and time will be carefully observed. Proposals received after the specified date and time shall be returned unopened. GCPS will not be responsible for late deliveries or delayed mail. The time stamp located at the reception desk of the Administration building shall serve as the official authority to determine lateness of any proposal.
- 1.30 **Delays in Schedule:** GCPS, at its sole discretion, may delay the scheduled due dates indicated above if it is to the advantage of the district to do so. GCPS will notify all registered proposers of all changes in scheduled due dates by written addendum.
- 1.31 **Additional Information:** No additional information may be submitted, or follow-up performed by any proposer after the stated due date unless specifically requested by GCPS.
- 1.32 **Affirmation:** The submission of a proposal affirms that the proposer has made it without prior understanding, agreement, or connection with any corporation, firm, or person submitting a proposal for the same materials, supplies, equipment, or services, and is in all respects fair and without collusion or fraud. The proposer agrees to abide by all terms and conditions of this RFP and the resulting contract. No outside terms and conditions will be considered unless approved by GCPS.
- 1.33 **Advertising:** In submitting a proposal, the proposer agrees not to use the results there from as a part of any commercial advertising unless permission in writing is granted by the Gadsden County School Board.
- 1.34 **Accuracy of Information:** Any proposal submitted to the Owner which is determined to contain information that is substantially inaccurate, misleading, exaggerated, or incorrect, shall be disqualified from consideration.
- 1.35 **Opening:** The Owner will publicly open and read each RFP as required by *255.0518 F.S.* and defined in the Schedule of Events. Incomplete or non-responsive proposals will be removed from consideration.

- 1.36 **Review:** Once each proposal has been read, at the owner's leisure, the review committee will review all proposals for compliance and score each section as indicated.
- A. The Owner reserves the right to contact a proposer for clarification if needed in determining compliance.
  - B. The review committee will select one Contractor to recommend to the Board for award and reserves the right not to base award exclusively on price.
- 1.37 **Acceptance/Rejection of Proposals:** The Owner reserves the right to waive minor irregularities in any proposal or to reject any and all proposals in whole or in part, with or without cause, and/or to accept the proposal that in its judgment will be in the best interest of GCPS. Minor irregularities are defined to be a variation from the terms and conditions which do not affect the price or give the vendor an advantage or benefit not enjoyed by other vendors or does not adversely impact the interest of GCPS.
- 1.38 **Disqualification:** Any or all proposals will be rejected if there is reason to believe that collusion exists between proposers. Proposals in which the prices obviously are unbalanced will be subject to rejection. Proposers not acknowledging all addenda may be rejected. Incomplete or illegible proposals will be rejected.
- 1.39 **Posting of Results:** Bid tabulations with recommended invitations will be posted for review by interested parties in the main lobby window of the Administration Building located at 35 Martin Luther King Jr. Blvd., Quincy, Florida 32351, on the date specified in the Schedule of Events and will remain posted for a period of 72 hours.
- A. The Owner will also post all recommended awards and addenda to the District's website: <http://www.gcps.k12.fl.us/?DivisionID=21299&ToggleSideNav=>
- 1.40 **Protests:** In the case of any doubt or difference of opinion as to the items or services to be furnished hereunder, the decision of the Owner shall be final and binding on both parties. Any person who is adversely affected by the terms, conditions and specifications contained in a solicitation, including any provisions governing the methods for ranking bids, proposals, or replies, awarding contracts, reserving rights of further negotiation, or modifying or amending any contract shall file a notice of protest in writing within 72 hours (Saturdays, Sundays and state holidays excluded) after the posting of the solicitation. Any person adversely affected by a decision or intended decision shall file a written protest within 72 hours (Saturdays, Sundays and state holidays excluded) after posting of the decision or intended decision. **Failure to file a protest within the time prescribed in Section 120.57(3), Florida Statutes, shall constitute a waiver of proceedings under Chapter 120, Florida Statutes.**
- 1.41 **Public Records:** Upon award or ten (10) days after opening, whichever is earlier, proposals become "public record" and shall be subject to public disclosure consistent with *chapter 119.07(3) (m), F.S.* Proposers must invoke the exemptions to disclosure provided by law in the response to the proposal, and must identify the data or other materials to be protected, and must state reasons why such exclusion from public disclosure is necessary. Any financial statements that are submitted are exempt from becoming public record. *Section 119.07 F.S.*
- 1.42 **Invoicing and Payment:** Payment will be made by the Owner upon completion of negotiated benchmarks.

A. Payment negotiation shall occur prior to signing of Agreement and shall become part of the Agreement.

- 1.43 **Indemnification:** To the fullest extent permitted by law, the proposer shall indemnify, hold harmless and defend the District, its Trustees, officers, agents, servants, and employees, from and against all claims, damages, losses, and expenses including, but not limited to, attorneys' fees and other legal costs such as those for paralegal, investigative, and legal support services, and the actual cost incurred for expert witness testimony, arising out of or resulting from the performance of services required under this Contract, provided that same is caused by the negligence, recklessness, or intentional wrongful conduct of the proposer or other person utilized by the proposer in the performance of the services. Nothing herein shall be deemed to affect the rights, privileges, and immunities of the District as set forth in Section 768.28, Florida Statutes.

The proposer, without exemption, shall indemnify and hold harmless the District, its employees and/or any of its Board of Trustees Members from liability of any nature or kind, including cost and expenses for or on account of any copyrighted, patented, or non-patented invention, process or item manufactured by the proposer. If the proposer used any design, device, or materials covered by letters, patent or copyright, it is mutually agreed and understood, without exception, that the proposer shall include all royalties or cost arising from the use of such design, device, or materials in any way involved in the work.

- 1.44 **Withdrawal of Proposal:** A written request for withdrawal, signed by the vendor, on the Vendor's company letterhead, may be considered if received by the GCPS purchasing officer within 72 hours after the proposal opening time and date indicated in the schedule of events. A request received in accordance with this provision may be granted by the department upon proof of the impossibility to perform based upon obvious error on the part of the vendor.

*End of Part One*

**PART 2 – RFP REQUIRED FORMATTING**

- 2.1 The proposer shall submit their proposal on 8.5 in. x 11 in. paper or same size electronically in PDF formatting, arranged in the same order as listed in this RFP. With the exception of headers and footers, font size shall not be smaller than 10. **All items listed in section 2.1 are mandatory.**
- A. **Cover Page: (5 points)** The cover page shall identify
    - 1. Company Name
    - 2. Due date and time
    - 3. RFP number
    - 4. The Owner's name, Gadsden County School Board
  - B. **Insurance: (5 points)** Copy of all certificates of insurance shall be provided. Include copy of DBPR license status from their web page if applicable and if available a BBB report.
  - C. **Bonding: (5 points)** Provide a letter of intent from a surety company acknowledging the firm may be bonded for the maximum amount of the project.
  - D. **Addendum to Bid: (5 points)** Print and sign all addenda.
  - E. **Drug Free Work Place Form: (5 points)** Include a signed copy.
  - F. **Public Entity Crimes Form: (5 points)** Include a signed copy.
  - G. **Minority and Woman Owned Businesses Form: (5 points)** Include a signed copy.
  - H. **Debarment Certification Form: (5 points)** Include a signed copy.
  - I. **Conflict of Interest Form: (5 points)** Include a signed copy.
  - J. **Vendor Registration/W-9 Form: (5 points)** Include a signed copy.
  - K. **Bid Proposal Form: (50 points)**
- 2.2 Once the proposal is ready to submit, it should be sealed in an envelope or boxed for ease of delivery and storage. It is required that the proposer label the outside of the envelope or box using the label provided herein. The number of proposal copies is specified in section 1.27.
- 2.3 Include in the Bid Proposal Form individual cost for each door set that includes materials, and labor.
- 2.4 **Substitutions:** Any substitutions must be submitted and approved by the Owner prior to submitting proposal. Sufficient information must accompany the request for substitution.
- 2.5 **Required Forms:**

# ADDENDUM TO SOLICITATION DOCUMENTS

Gadsden County Schools  
35 Martin Luther King Jr. Blvd.  
Quincy, Florida 32351

Solicitation Addendum No. \_\_\_\_\_

Date: \_\_\_\_\_

RFP No. \_\_\_\_\_

Project Name: \_\_\_\_\_

### NOTICE TO ALL BIDDERS

The following addendum shall be made part of the Contract Documents and the Bidder shall acknowledge receipt on the Bid Form. It is being issued for the purpose of clarifying the intent of the Contract Documents. Each Bidder is instructed to incorporate this addendum into their Bid Documents and bid accordingly.

### PRE-BID QUESTIONS and ANSWERS

1	Q	
	A	
2	Q	
	A	
3	Q	
	A	
4	Q	
	A	
5	Q	
	A	
6	Q	
	A	
7	Q	
	A	
8	Q	
	A	

\_\_\_\_\_  
Preparer's Name

\_\_\_\_\_  
Date

\_\_\_\_\_  
Authorizing Agent

\_\_\_\_\_  
Date

**NOTE: This document must be signed and included with your Bid**

**FORM 00450**

**DRUG-FREE WORK PLACE**

Drug-Free Work Place:    Yes \_\_\_\_\_                      N/A \_\_\_\_\_

If **yes** please complete the form.

The undersigned vendor in accordance with Florida Statute 287.087 hereby certifies that  
\_\_\_\_\_ does:

(Name of Business)

Publish statement notifying employees that the unlawful manufacture, distribution, dispensing, possession, or use of a controlled substance is prohibited in the workplace and specifying the actions that will be taken against employees for violations of such prohibition.

Inform employees about the dangers of drug abuse in the workplace, the business’s policy of maintaining a drug-free workplace, any available drug counseling, rehabilitation, and employee assistance programs, and the penalties that may be imposed upon employees for drug abuse violations.

Give each employee engaged in providing the commodities or contractual services that are proposed a copy of the statement specified in subsection (1).

In the statement specified in subsection (1), notify the employees that, as a condition of working on the commodities or contractual services that are under bid, the employee will abide by the terms of the statement and will notify the employer of any conviction of, or plea of guilty or nolo contendere to, any violation of Chapter 893 or of any controlled substance law of the United States or any state, for a violation occurring in the workplace no later than five (5) days after such conviction.

Impose a sanction on, or required the satisfactory participation in a drug abuse assistance or rehabilitation program is such is available in the employee’s community, by any employee who is so convicted.

Make a good faith effort to continue to maintain a drug-free workplace through implementation of this section.

As the person authorized to sign the statement, I certify that this firm complies fully with the above requirements.

\_\_\_\_\_  
*Proposer’s Signature*

\_\_\_\_\_  
*Date*

FORM 00451

SWORN STATEMENT UNDER SETION 287.133 (3) (A)
FLORIDA STATUTE ON PUBLIC ENTITY CRIMES

THIS FORM MUST BE SIGNED IN THE PRESENCE OF A NOTARY PUBLIC OR OTHER OFFICER AUTHORIZED TO ADMINISTER OATHS.

1. This sworn statement is submitted with Bid, Proposal or Contract for:
\_\_\_\_\_

2. This sworn statement is submitted by, \_\_\_\_\_, whose business address is, \_\_\_\_\_, and (if applicable) Federal Employer Identification Number (FEIN) is \_\_\_\_\_ (if the entity has no FEIN, include the Social Security Number of the individual signing this sworn statement).

3. My name is \_\_\_\_\_ and my relationship to the entity named above is \_\_\_\_\_ (title).

4. I understand that a "public entity crime" as defined in paragraph 287.133 (1) (g) Florida Statute, means a violation of any state or federal law by a person with respect to and directly related to the transaction of business with any public entity or with an agency or political subdivision of any other state or with the United States including, but not limited to , any bid or contract for goods or services to be provided to any public entity or any agency or public subdivision of any other state or of the United States and involved antitrust, fraud, theft, bribery, collusion, racketeering, conspiracy or material misrepresentation.

5. I understand that "convicted" or "convicted" as defined in paragraph 287.133 (1) (b), Florida Statutes, means a finding of guilt or a conviction of a public entity crime with or without an adjudication of guilt, in any federal or state trial court of records relating to charges brought by indictment or information after July 1, 1989, as a result of a jury verdict, non-jury trial, or entry of a plea of guilty or nolo contendere.

6. I understand that an "affiliate" as defined in Paragraph 287 .133 (1) (a), Florida Statutes, means:

- a. A predecessor or successor of a person convicted of a public entity crime; or
b. An entity under the control of any natural person who is active in the management of the entity and who has been convicted of a public entity crime. The term "affiliate" includes those officers, directors, executives, partners, shareholders, employees, members, and agents who are active in the management of an affiliate. The ownership by one of shares constituting a controlling income among persons when not for fair interest in another person, or a pooling of equipment or income among persons when not for fair market value under an length agreement, shall be a prima facie case that one person controls another person. A person who knowingly convicted of a public entity crime, in Florida during the preceding 36 months shall be considered an affiliate.

7. I understand that a "person" as defined in paragraph 287 .133 (1) (e), Florida Statutes, means any natural person or entity organized under the laws of the state or of the United States with the legal power to enter into a binding contract provision of goods or services let by a public entity, or which otherwise transacts or applies to transact business with a public entity. The term "person" includes those officers, directors, executives, partners, shareholders, employees, members, and agents who are active in management of an entity.

8. Based on information and belief, the statement which I have marked below is true in relation to the entity submitting this sworn statement. (Please indicate which statement applies)



Neither the entity submitting this sworn statement, nor any officers, directors, executive, partners, shareholders, employees, member, or agents who are active in management of the entity, nor affiliate of the entity have been charged with and convicted of a public entity crime subsequent to July 1, 1989.

The entity submitting this sworn statement, or one or more of the officers, directors, executives, partners, shareholders, employees, members, or agents who are active in management of the entity, or an affiliate of the entity has been charged with and convicted of a public entity crime subsequent to July 1, 1989 And (please attach a copy of the final order)

The person or affiliate was placed on the convicted vendor list. There has been a subsequent proceeding before a hearing officer of the State of Florida, Division of Administrative Hearings. The final order entered by the hearing officer determined that it was in public interest to remove the person or affiliate from the convicted vendor list. (Please attach a copy of the final order)

The person or affiliate has not been placed on the convicted vendor list. (Please describe any action taken by, or pending with, the department of General Services)

\_\_\_\_\_  
Signature

\_\_\_\_\_  
Date

PERSONALLY APPEARED BEFORE ME, the undersigned authority, who, after first being sworn by me, affixed his/her signature at the space provided above on this day of \_\_\_\_\_, 20\_\_\_\_, and is personally known to me, or has provided \_\_\_\_\_ as identification.

STATE OF FLORIDA

COUNTY OF: \_\_\_\_\_

My Commission expires: \_\_\_\_\_

Notary Public

**FORM 00452**

**MINORITY AND WOMAN OWNED BUSINESS DECLARATION FORM**

Minority/Woman Owned Business: Yes  N/A

If yes, please complete the form.

Proposer hereby declares that it is a Minority/Woman Owned Business Enterprises, as defined by section 288.703. Florida Statutes, by virtue of the following:

Type of Business (check applicable area):

- African American
- Hispanic American
- Native Americans
- Asian American
- American Woman

**Note: Minority Business Enterprises, Small Businesses, and Minority Businesses terms are defined in Chapter 288.703, Florida Statutes, and are included below. Chapter 287.094, Florida Statutes, states that it is unlawful for any individual to falsely represent any entity as a minority business enterprise. A person in violation of 287.094, Florida Statutes, is guilty of a felony of the second degree.**

Proposer:
Certified by (Name of Public Entity, if applicable):
Certificate Number/Attach Copy:
Signature & Date:

Florida Statues 288.703 definitions – As used in section 288.703, the following words, and terms shall have the following meanings unless the content shall indicate another meaning or intent:

- (1) “Small business” means an independently owned and operated business concern that employee 200 or fewer permanent full-time employees and that, together with its affiliates, has a net worth of not more than \$5 million or any firm based in this state which has a Small Business Administration 8(a)

certification. As applicable to sole proprietorships, the \$5 million net worth requirement shall include both personal and business investments.

- (2) “Minority Business Enterprises” means any small business concern as defined in subsection (1) which is organized to engage in commercial transactions, which is domiciled in Florida, and which is at least 51% owned by minority persons who are members of an insular group that is of a particular racial, ethnic, or gender make-up or national origin, which has been subjected historically to disparate treatment due to identification in and with that group resulting in an under-representation of commercial enterprises under the group’s control, and whose management and daily operations are controlled by such persons. A minority business enterprise may primarily involve the practice of a profession. Ownership by a minority person does not include ownership which is the result of a transfer from a nonminority person to a minority person within a related immediate family group if the combined total net asset value of all members of such family group exceeds \$1 million. For purposes of this subsection, the term “related immediate family group” means one or more children less than 16 years of age and a parent of such children or the spouse of such parent residing in the same house or living unit.
- (3) “Minority person” means a lawful, permanent resident of Florida who is:
- a. An African American, a person having origins in any of the black racial groups of the African Diaspora, regardless of cultural origin.
  - b. A Hispanic American, a person of Spanish or Portuguese culture with origins in Spain, Portugal, Mexico, South America, Central America, or the Caribbean, regardless of race.
  - c. An Asian American, a person having origins in any of the original peoples of the Far East, Southeast Asia, the Indian Subcontinent, or the Pacific Islands, including the Hawaiian Islands prior to 1778.
  - d. A Native American, a person who has origins in any of the Indian Tribes of North America prior to 1835, upon presentation of proper documentation thereof as established by rule of the Department of Management Services.
  - e. An American woman.
- (4) “Certified minority business enterprise” means a business which has been certified by the certifying organization or jurisdiction in accordance with s. [287.0943](#)(1) and (2).
- (5) “Department” means the Department of Management Services.
- (6) “Ombudsman” means an office or individual whose responsibilities include coordinating with the Office of Supplier Diversity for the interests of and providing assistance to small and minority business enterprises in dealing with governmental agencies and in developing proposals for changes in state agency rules.
- (7) “Financial institution” means any bank, trust company, insurance company, savings and loan association, credit union, federal lending agency, or foundation.
- (8) “Secretary” means the secretary of the Department of Management Services.
- It is unlawful for any individual to falsely claim to be a minority business enterprise for purposes of qualifying for certification with any governmental certifying organization as a minority business enterprise in order to participate under a program of a state agency which is designed to assist certified minority business enterprises in the receipt of contracts with the agency for the provision of goods or services. The certification of any contractor, firm, or individual obtained by such false representation shall be permanently revoked, and the entity shall be barred from doing business with state government for a period of 36 months. Any person who violates this section is guilty of a felony of the second degree, punishable as provided in s. [775.082](#), s. [775.083](#), or s. [775.084](#).

**FORM 00453****INSTRUCTIONS FOR DEBARMENT CERTIFICATION**

---

1. By signing and submitting this form, the prospective lower tier participant is providing the certification set out herein in accordance with these instructions.
2. The certification in this clause is a material representation of fact upon which reliance was placed when this transaction was entered into. If it is later determined that the prospective lower tier participant knowingly rendered an erroneous certification, in addition to other remedies available to the Federal Government, the department of agency with which this transaction originated may pursue available remedies, including suspension and/or debarment.
3. The prospective lower tier participant shall provide immediate written notice to the person to whom this proposal is submitted if at any time the prospective lower tier participant learns that its certification was erroneous when submitted or has become erroneous by reason of changed circumstances.
4. The terms “covered transaction”, “debarred”, “suspended”, “ineligible”, “lower tier covered transaction”, “participant”, “person”, “primary covered transaction”, “principal”, “proposal”, “voluntarily exclude”, as used in this clause, have the meanings set out in the Definitions and Coverage sections of rules implementing Executive Order 12549. You may contact the person to which this proposal is submitted for assistance in obtaining a copy of these regulations.
5. The prospective lower tier participant agrees by submitting this form that, should the proposed covered transaction be entered into, it shall not knowingly enter into any lower tier covered transaction with a person who is debarred, suspended, declared ineligible, or voluntarily excluded from participation in this covered transaction, unless authorized by the department or agency with which this transaction originated.
6. The prospective lower tier participant further agrees by submitting this form that it will include this clause titled “Certification Regarding Debarment, Suspension, Ineligibility and Voluntary Exclusion – Lower Tier Covered Transactions”, without modification in all lower tier covered transactions and in all solicitations for lower tier covered transactions.
7. A participant in a covered transaction may rely upon a certification of a prospective participant in a lower tier covered transaction that it is not debarred, suspended, ineligible, or voluntarily excluded from the covered transaction, unless it knows that the certification is erroneous. A participant may, but is not required to check the Non-Procurement List.
8. Nothing contained in the foregoing shall be construed to require establishment of a system of records in order to render in good faith the certification required by this clause. The knowledge and information of a participant is not required to exceed that which is normally possessed by a prudent person in the ordinary course of business dealings.

Except for transactions authorized under paragraph 5 of these instructions, if a participant in a covered transaction knowingly enters into a lower tier covered transaction with a person who is suspended,

debarred, ineligible, or voluntarily excluded from participation in this transaction may pursue available remedies, including suspension and/or debarment.

**CERTIFICATION REGARDING DEBARMENT**  
**Suspension, Ineligibility, and voluntary exclusion**  
**Lower tier covered transactions**

---

This certification is required by the regulations implementing *Executive Order 12549, Debarment and Suspension, 7 CFR Part 3017, Section 3017.510 Participants responsibilities*. The regulations were published as **Part IV of the January 30, 1989, Federal Register (pages 4722-4733)**.

\*\*\*\*\* BEFORE COMPLETING CERTIFICATION, READ INSTRUCTIONS ON NEXT PAGE \*\*\*\*\*

(1) The Prospective lower tier participant certifies, by submission of this proposal, that neither it nor its principals is presently debarred, suspended, proposed for debarment, declared ineligible, or voluntarily excluded from participation in this transaction by any Federal department of agency.

(2) Where the prospective lower tier participant is unable to certify to any of the statements in this certification, such prospective participant shall attach an explanation to this proposal.

\_\_\_\_\_  
*Organization Name*

\_\_\_\_\_  
*Printed Names and Title*

\_\_\_\_\_  
*Signature*

\_\_\_\_\_  
*Date*

**FORM 00454**

**CONFLICT OF INTEREST STATEMENT**

I HEREBY CERTIFY that

1. I, *(printed name)* \_\_\_\_\_, am the  
*(Title)* \_\_\_\_\_ and the duly authorized representative of the firm of  
*(Firm Name)* \_\_\_\_\_ whose address is  
 \_\_\_\_\_,  
*Address* \_\_\_\_\_, *City* \_\_\_\_\_, *State* \_\_\_\_\_, *Zip Code* \_\_\_\_\_

and that I possess the Legal authority to make this affidavit on behalf of myself and the firm for which I am acting;

2. Except as listed below, no employee, officer, or agent of the firm have any conflicts of interest, real or apparent, due to ownership, other clients, contracts, or interests associated with this project; and,

3. This Bid Submittal is made without prior understanding, agreement, or connection with any corporation, firm, or person submitting a bid for the dame services, and is in all respects fair and without collusion or fraud.

EXCEPTIONS to items above (List): \_\_\_\_\_

Signature: \_\_\_\_\_

Printed Name \_\_\_\_\_

Firm Name: \_\_\_\_\_

Date: \_\_\_\_\_

STATE OF \_\_\_\_\_

COUNTY OF \_\_\_\_\_

Sworn to and subscribed before me this \_\_\_\_\_ day of \_\_\_\_\_, 20\_\_\_\_\_, by  
\_\_\_\_\_, who is personally known to me or who has produced  
\_\_\_\_\_ as identification.

\_\_\_\_\_  
Notary Public – State of \_\_\_\_\_

Type or print name: \_\_\_\_\_

(Seal)

Commission No.: \_\_\_\_\_

Commission Expires: \_\_\_\_\_

<p><b>Form W-9</b> (Rev. October 2007) Department of the Treasury Internal Revenue Service</p>	<p><b>Request for Taxpayer Identification Number and Certification</b></p>	<p><b>Give form to the requester. Do not send to the IRS.</b></p>
--	--	---

Print or type See Specific Instructions on page 2.	Name (as shown on your income tax return)	
	Business name, if different from above	
	Check appropriate box: <input type="checkbox"/> Individual/Sole proprietor <input type="checkbox"/> Corporation <input type="checkbox"/> Partnership <input type="checkbox"/> Limited liability company. Enter the tax classification (D=disregarded entity, C=corporation, P=partnership) ▶ ..... <input type="checkbox"/> Exempt payee <input type="checkbox"/> Other (see instructions) ▶	
	Address (number, street, and apt. or suite no.)	Requester's name and address (optional)
	City, state, and ZIP code	
List account number(s) here (optional)		

**Part I Taxpayer Identification Number (TIN)**

Enter your TIN in the appropriate box. The TIN provided must match the name given on Line 1 to avoid backup withholding. For individuals, this is your social security number (SSN). However, for a resident alien, sole proprietor, or disregarded entity, see the Part I instructions on page 3. For other entities, it is your employer identification number (EIN). If you do not have a number, see *How to get a TIN* on page 3.

Social security number : : : : : : : : :	or	Employer identification number : : : : : : : : :
---	----	---

**Note.** If the account is in more than one name, see the chart on page 4 for guidelines on whose number to enter.

**Part II Certification**

Under penalties of perjury, I certify that:

- The number shown on this form is my correct taxpayer identification number (or I am waiting for a number to be issued to me), and
- I am not subject to backup withholding because: (a) I am exempt from backup withholding, or (b) I have not been notified by the Internal Revenue Service (IRS) that I am subject to backup withholding as a result of a failure to report all interest or dividends, or (c) the IRS has notified me that I am no longer subject to backup withholding, and
- I am a U.S. citizen or other U.S. person (defined below).

**Certification instructions.** You must cross out item 2 above if you have been notified by the IRS that you are currently subject to backup withholding because you have failed to report all interest and dividends on your tax return. For real estate transactions, item 2 does not apply. For mortgage interest paid, acquisition or abandonment of secured property, cancellation of debt, contributions to an individual retirement arrangement (IRA), and generally, payments other than interest and dividends, you are not required to sign the Certification, but you must provide your correct TIN. See the instructions on page 4.

<b>Sign Here</b>	Signature of U.S. person ▶	Date ▶
------------------	----------------------------	--------

**General Instructions**

Section references are to the Internal Revenue Code unless otherwise noted.

**Purpose of Form**

A person who is required to file an information return with the IRS must obtain your correct taxpayer identification number (TIN) to report, for example, income paid to you, real estate transactions, mortgage interest you paid, acquisition or abandonment of secured property, cancellation of debt, or contributions you made to an IRA.

Use Form W-9 only if you are a U.S. person (including a resident alien), to provide your correct TIN to the person requesting it (the requester) and, when applicable, to:

- Certify that the TIN you are giving is correct (or you are waiting for a number to be issued),
- Certify that you are not subject to backup withholding, or
- Claim exemption from backup withholding if you are a U.S. exempt payee. If applicable, you are also certifying that as a U.S. person, your allocable share of any partnership income from a U.S. trade or business is not subject to the withholding tax on foreign partners' share of effectively connected income.

**Note.** If a requester gives you a form other than Form W-9 to request your TIN, you must use the requester's form if it is substantially similar to this Form W-9.

**Definition of a U.S. person.** For federal tax purposes, you are considered a U.S. person if you are:

- An individual who is a U.S. citizen or U.S. resident alien,
- A partnership, corporation, company, or association created or organized in the United States or under the laws of the United States,
- An estate (other than a foreign estate), or
- A domestic trust (as defined in Regulations section 301.7701-7).

**Special rules for partnerships.** Partnerships that conduct a trade or business in the United States are generally required to pay a withholding tax on any foreign partners' share of income from such business. Further, in certain cases where a Form W-9 has not been received, a partnership is required to presume that a partner is a foreign person, and pay the withholding tax. Therefore, if you are a U.S. person that is a partner in a partnership conducting a trade or business in the United States, provide Form W-9 to the partnership to establish your U.S. status and avoid withholding on your share of partnership income.

The person who gives Form W-9 to the partnership for purposes of establishing its U.S. status and avoiding withholding on its allocable share of net income from the partnership conducting a trade or business in the United States is in the following cases:

- The U.S. owner of a disregarded entity and not the entity,

# BID DOOR REPLACEMENT PROJECT – GREENSBORO ELEMENTARY SCHOOL

(TO BE COPIED BY THE BIDDER ON THEIR LETTERHEAD AND SUBMITTED)

TO: Gadsden County School Board  
35 Martin Luther King Jr. Blvd.  
Quincy, Florida 32351

FROM: \_\_\_\_\_  
\_\_\_\_\_  
\_\_\_\_\_  
Office: \_\_\_\_\_  
Cell: \_\_\_\_\_  
E-mail: \_\_\_\_\_

Vendor ID: \_\_\_\_\_

Gentlemen:

I have received the Project Documents entitled “\_\_\_\_\_”  
dated \_\_\_\_\_ as prepared by \_\_\_\_\_. I have also received the  
following Addenda numbers \_\_\_\_\_, \_\_\_\_\_, \_\_\_\_\_, \_\_\_\_\_, \_\_\_\_\_, \_\_\_\_\_, and have included their provisions in my proposal.  
I have examined all the Project Documents and the site and submit the following BID. \$ \_\_\_\_\_

Set # 1 \$ \_\_\_\_\_ Set # 2 \$ \_\_\_\_\_ Set # 3 \$ \_\_\_\_\_ Set # 4 \$ \_\_\_\_\_  
Set # 5 \$ \_\_\_\_\_ Set # 6 \$ \_\_\_\_\_ Set # 7 \$ \_\_\_\_\_ Set # 8 \$ \_\_\_\_\_  
Set # 9 \$ \_\_\_\_\_

By submitting this proposal, I agree:

- 1 To enter into and execute a contract within ten (10) calendar days after notice of award, and to furnish performance bonds and labor and material payment bonds in accordance with section 1.12 of the general conditions.
- 2 To accomplish the work in accordance with the Project Documents and to commence such work on the date to be specified by the written “Notice to Proceed” and to substantially complete the project on or before the date specified in the Contract Documents.

*I (We), the undersigned, hereby certify that I (We) have carefully examined the foregoing Proposal after the same was completed and have verified each item placed thereon; and I (We) agree to indemnify, defend and save harmless, GADSDEN COUNTY SCHOOL BOARD and their agents, against any cost, damage or expense which it may incur or be caused by an error in my (our) preparation of same.*

*In witness whereof, the Bidder has hereunto set his signature and affixed his seal this \_\_\_\_\_ day of \_\_\_\_\_, A.D., 20 \_\_\_\_\_.*

\_\_\_\_\_  
*Authorizing Signature*

(SEAL)

\_\_\_\_\_  
*Date*



**FORM 00457**

**IDENTIFICATION LABEL**

**NOTICE TO ALL PROPOSERS:** A label has been provided to properly identify your bid. Place the proposal in a sealed envelope, complete the label, and affix it to the front of the box.

The Superintendent’s office is open 8 a.m. – 5:00 p.m. Monday through Friday. If you hand deliver a proposal, a representative will be available to time/date stamp your submittal during these hours.

Cut out the label below and attach it to your envelope or box.

<b>SEALED PROPOSAL – DO NOT OPEN</b>		<b>SEALED PROPOSAL – DO NOT OPEN</b>	
<b>Proposal Title:</b>	_____		
<b>RFQ Number:</b>	_____		
<b>Opened Date:</b>	_____		
<b>From:</b>	_____		
<b>Address:</b>	_____		
	_____		
<b>Deliver To:</b>	<b>School Board of Gadsden County</b> <b>Finance / Purchasing Department</b> <b>35 Martin Luther King Jr. Blvd.</b> <b>Quincy, Florida 32351</b>		
<b>SEALED PROPOSAL – DO NOT OPEN</b>		<b>SEALED PROPOSAL – DO NOT OPEN</b>	

*End of Part Two*

## PART 3 – GENERAL REQUIREMENTS

3.1 **Summary:** The purpose of this solicitation is to establish a contract with a qualified Door and Hardware Contractor to provide DOOR AND HARDWARE REPLACEMENT AS SPECIFIED IN THE PROJECT DOCUMENTS. The proposal shall include all specified or implied materials and equipment necessary for a complete turnkey installation.

3.2 **Scope of Work:** General requirements for the scope of work include:

- A. **Hours:** It shall be assumed, all work taking place during active school hours will be coordinated around student activities. Disruptive work will be scheduled outside normal school hours.
- B. **Safety and Security:** The Safety and Security of the immediate work site shall be the Contractor's responsibility. While the Owner will make every effort to work with the Contractor, there will be times such as change of class where the Contractor will be required to pause work to allow student traffic.
  - 1. On site materials do not become the responsibility of the Owner until fully installed.
  - 2. On-site storage will be allowed only in Owner designated areas and shall be fenced.
  - 3. The Contractor shall assure project doors can be secured at the end of each day before leaving the site.
- C. **Demolition:** This project includes demolition and disposal of existing doors and associated hardware as specified elsewhere.
  - 1. The Contractor shall be required, prior to the disposal, to remove all hardware from doors and turn over to the Owner to salvage any useful items. Hardware not salvaged by the Owner will be disposed of by the Contractor.
- D. **Installation:** The Contractor will work with the Owner in retrofitting the existing door openings. The contractor shall demonstrate satisfactory operation of the doors and hardware prior to final payment. All inspections shall be performed by the Director of Facilities for the Gadsden County School Board or his designee.
  - 1. It shall be the contractor's responsibility to remove and reinstall any security system contacts or wiring that may be involved in the door replacement.
- E. **Toilet Facilities: Use of the schools restrooms is strictly prohibited.** The Contractor shall provide temporary toilet facilities for their workers. Location shall be coordinated with the Owner.
- F. **Site Cleanup:** Site cleanup shall be done daily. The Contractor is responsible for providing their own dumpster. **Use of the schools dumpster is strictly prohibited.**

3.3 **Project Specifications:**

A. **Door Schedule**

# GREENSBORO ELEMENTARY SCHOOL

320-003-0003

559 Greensboro Hwy  
Quincy, FL 32351

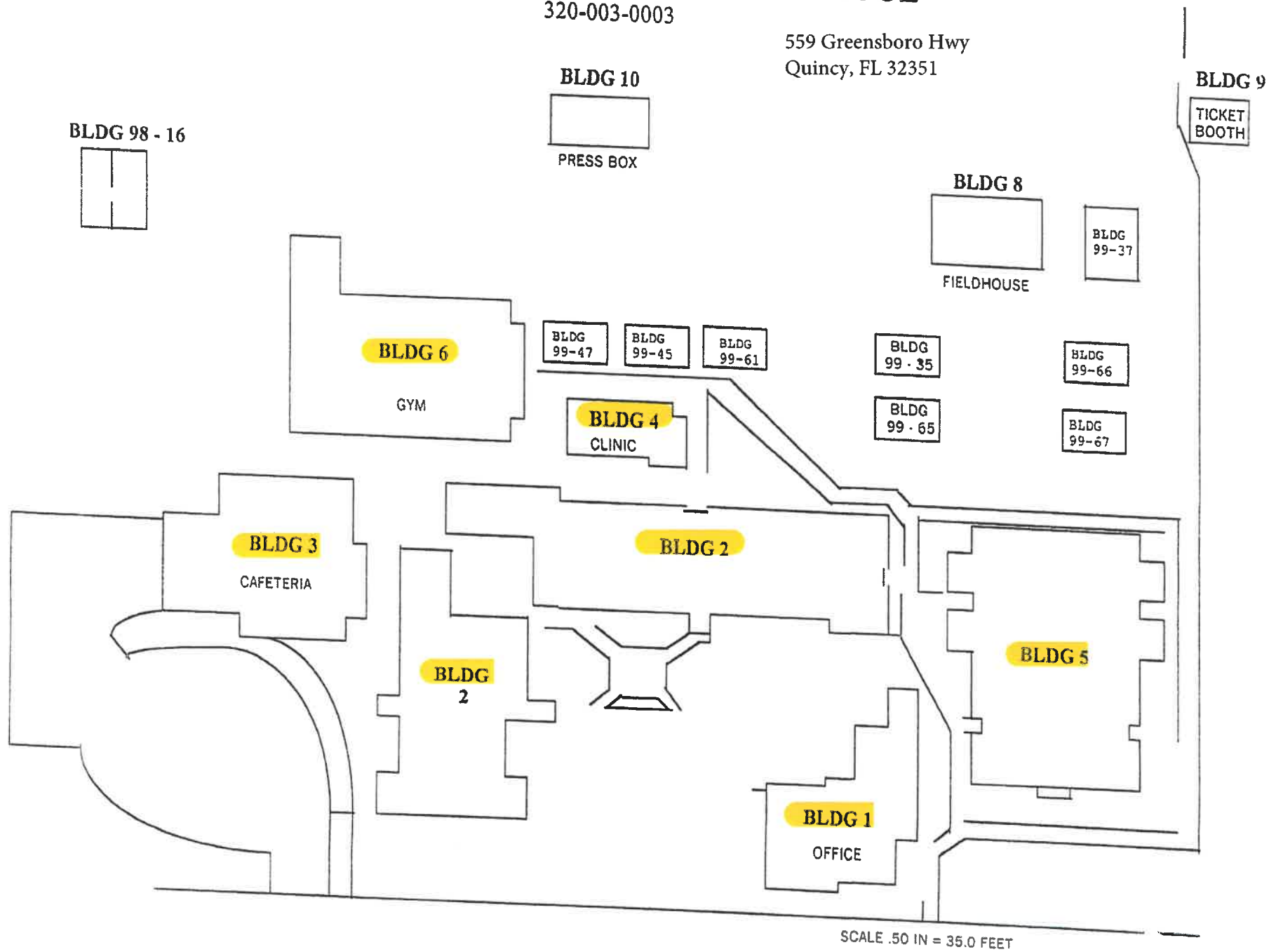

SCALE .50 IN = 35.0 FEET

# GREENSBORO ELEMENTARY HIGH

320-003-0003

## BLDG 1

ADMINISTRATION

Doors 100  
100A

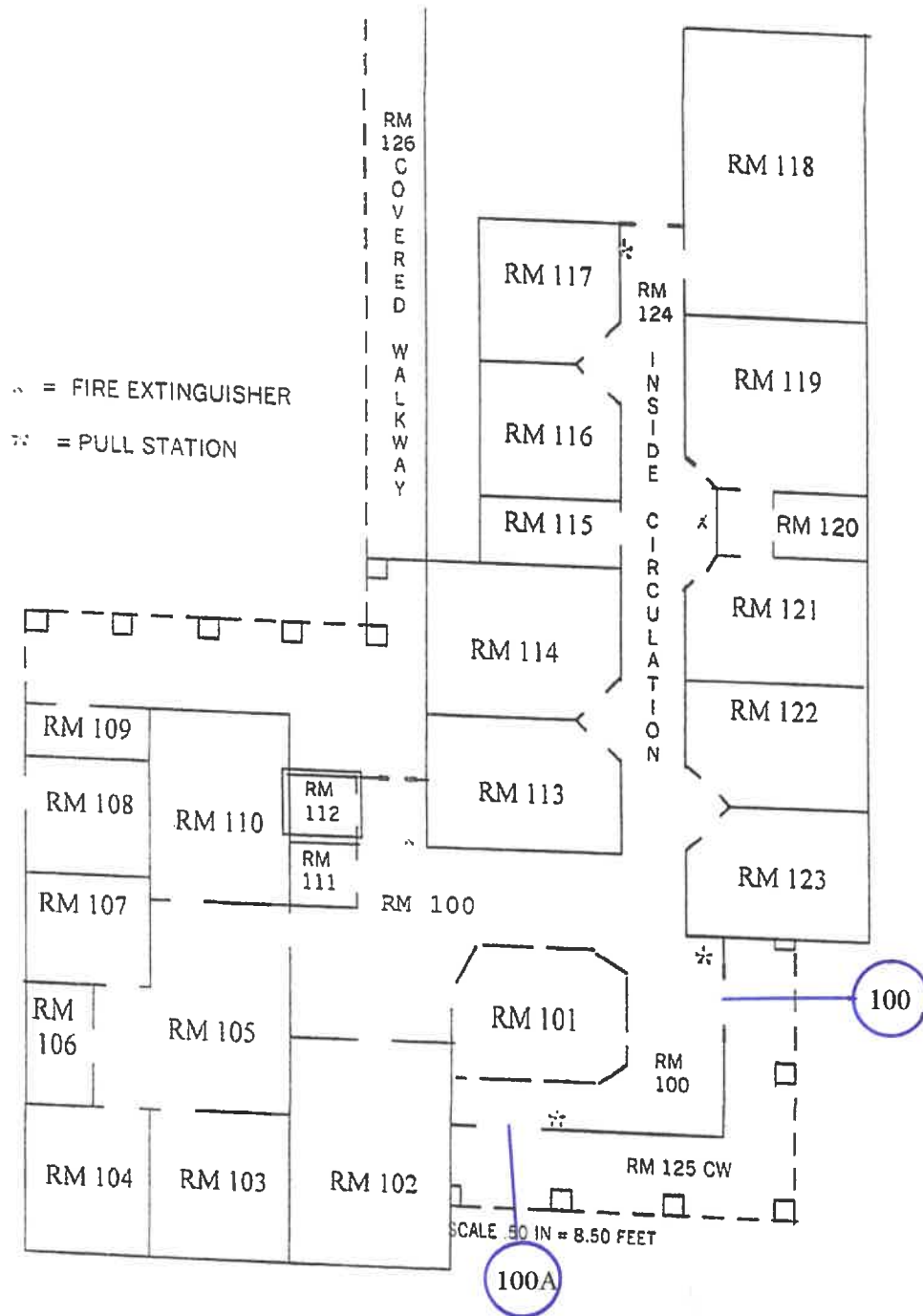

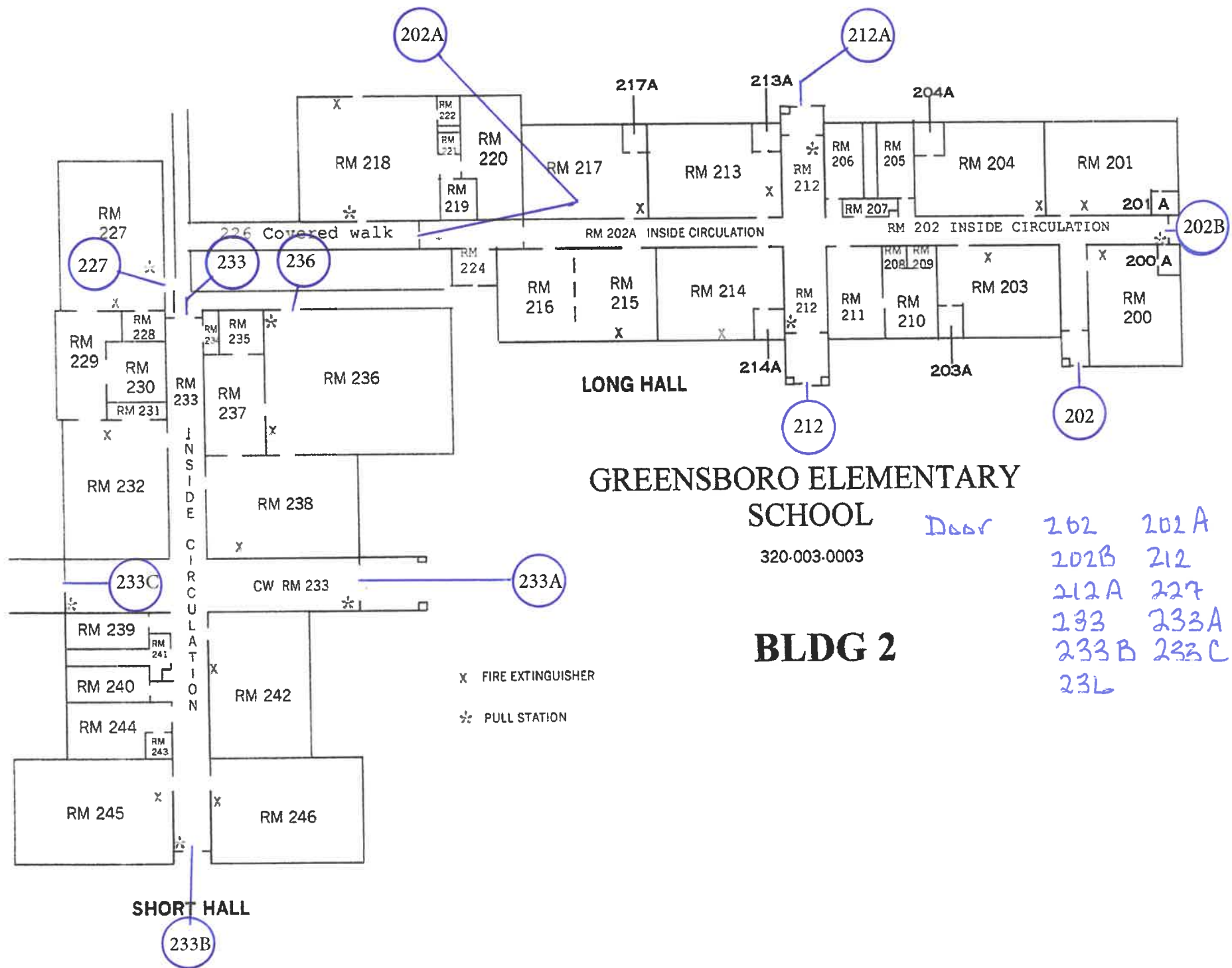

Door 202 202A  
202B 212  
212A 227  
233 233A  
233B 233C  
233L

# GREENSBORO ELEMENTARY SCHOOL

320-003-0003

DOORS: 300  
300 A  
300 B

## BLDG 3

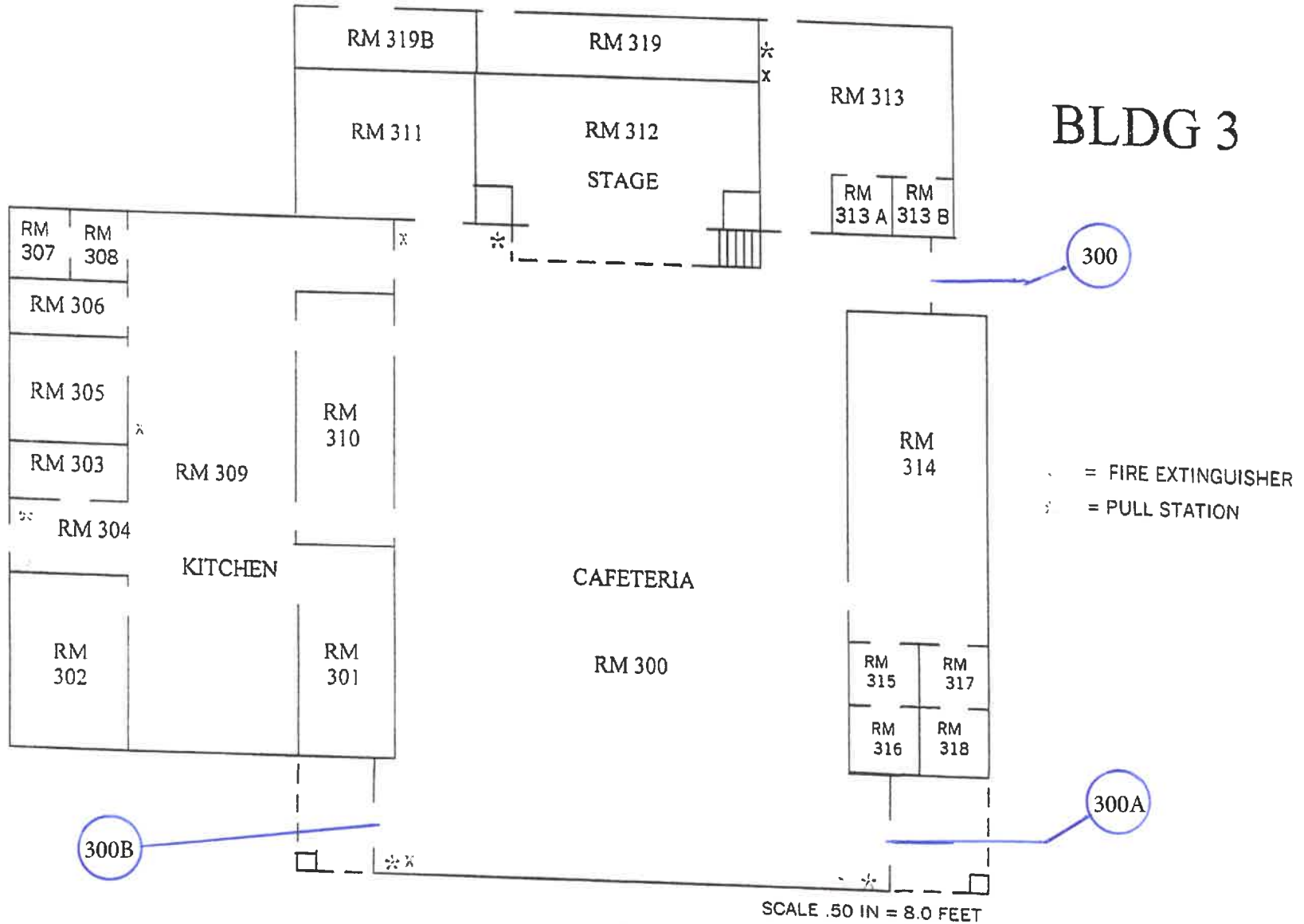

# GREENSBORO ELEMENTARY SCHOOL

320-003-0003

Doors: 407

## BLDG 4

### CLINIC

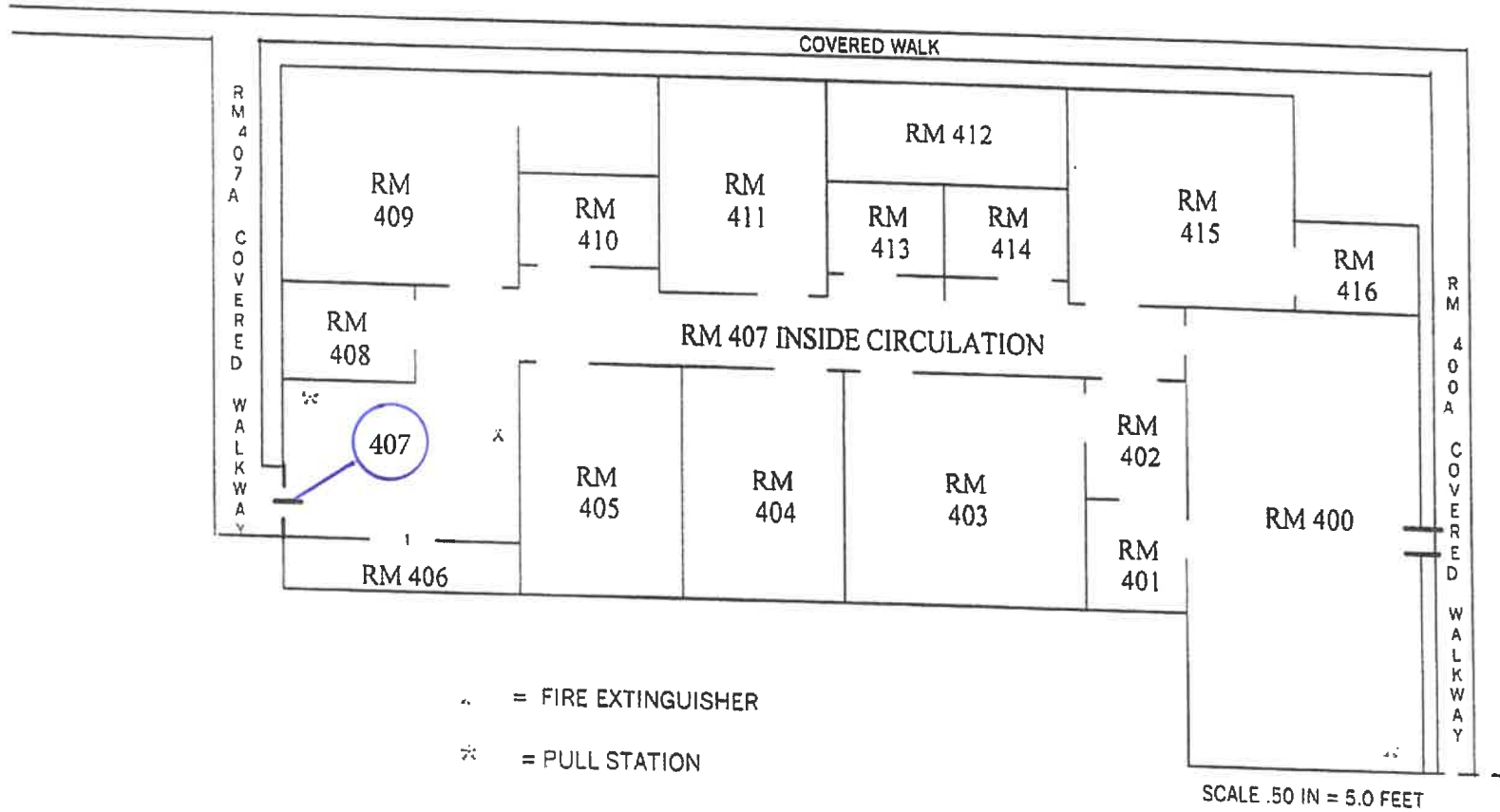

# GREENSBORO ELEMENTARY SCHOOL

320-003-0003

Doors: 516  
516A  
507A  
514A

## BLDG 5

LIBRARY / CLASSROOMS

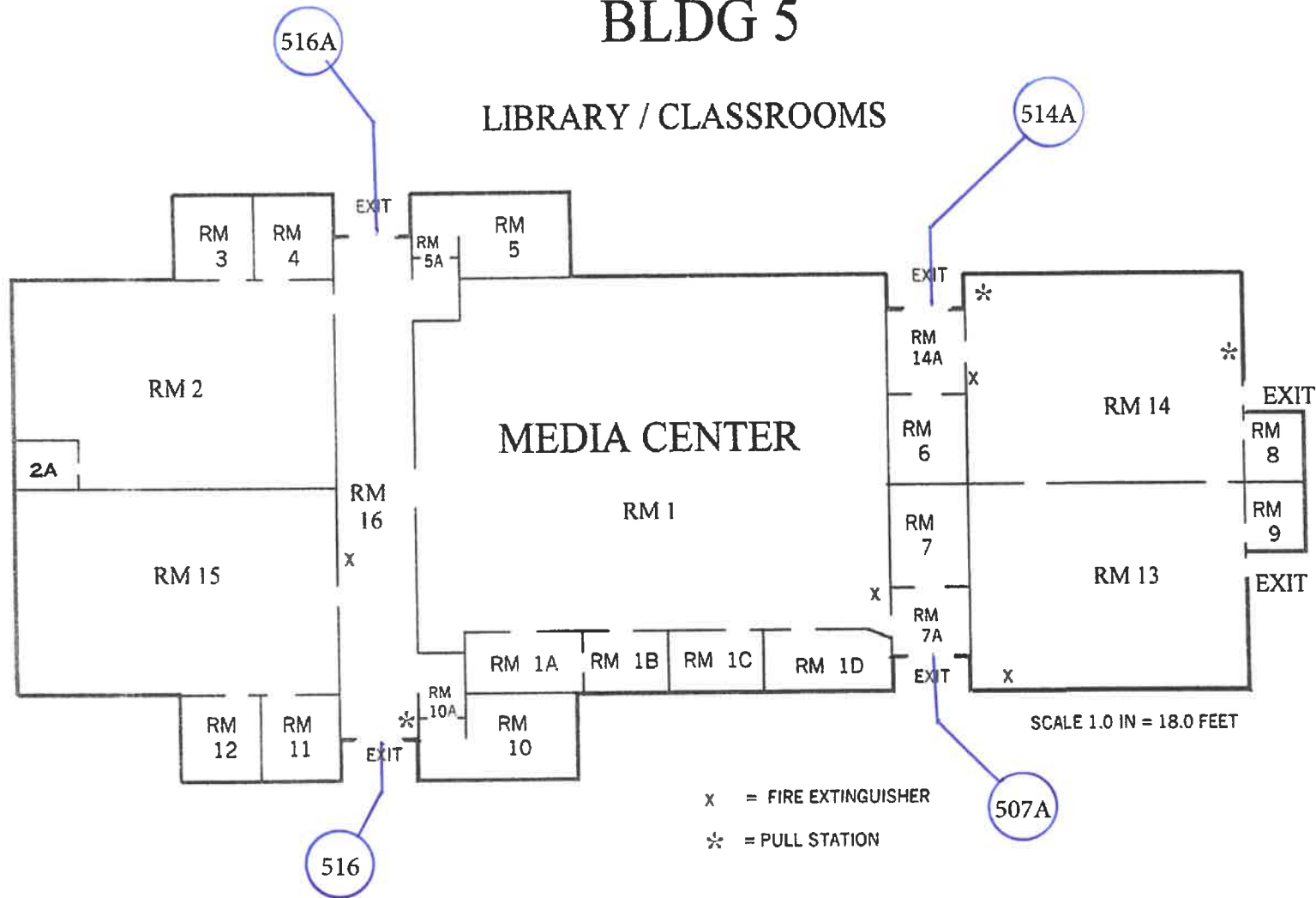



GREENSBORO ELEMENTARY  
SCHOOL

320-003-0003

BLDG 6

Doors  
601  
601A  
602  
603  
616  
617

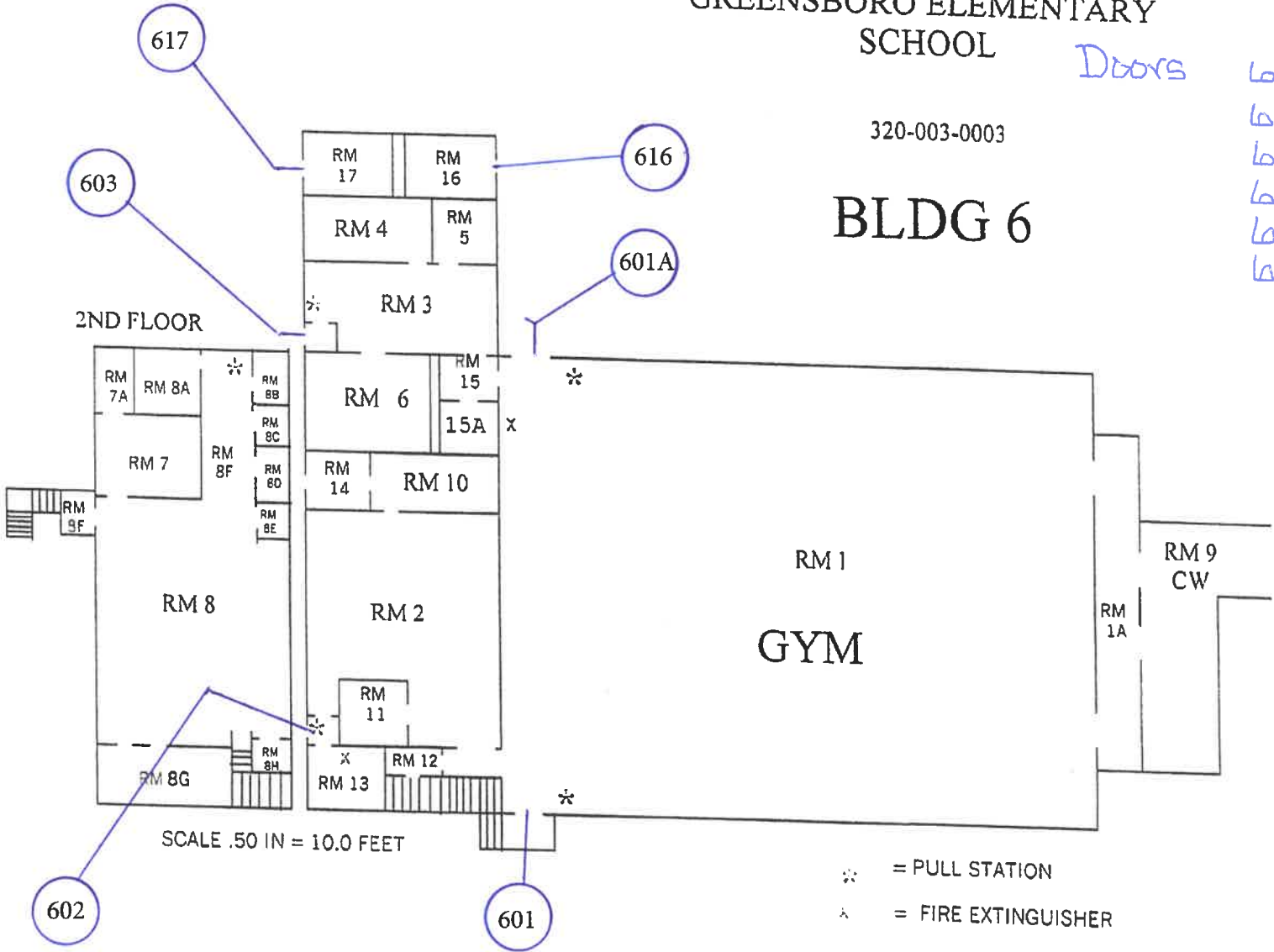

SCALE .50 IN = 10.0 FEET

- \* = PULL STATION
- X = FIRE EXTINGUISHER

**B. Hardware Schedule**

<b>Set # 1</b>	<b>Qt.</b>	<b>Description</b>
	-	Aluminum Jamb REMAINS, 6' opening
	1 Pair	HMD 18 GA 1 3/4, 6-0 x 6-8 GALV, A60 w/4" x 24" Light w/Glass RHR
	2	Pemko CFM79HD CLR Continuous Hinge
	1	Corbin Russwin CR 907 Mullion USP 84"
	2	Corbin Russwin ED 5200 TH955ET M54 630 Rim Panic w/ 0 Bitted N4 Cylinder
	2	Corbin Russwin DC 6210 M54 689 TRI PACK Door Closer
	2	Pemko 216 AV 36" Mill Finish Door Bottom
	1 Set	Pemko 303 AV 7284 Mill Finish Weather Stripping

Doors with Set #1:

100	100A	202	202A	202B	212	212A	224	233	233A
233B	233C	300	300A	300B	407				

<b>Set # 2</b>	<b>Qt.</b>	<b>Description</b>
	-	Aluminum Jamb REMAINS, single door
	1	HMD 18 GA 1 3/4, 6-0 x 6-8 GALV, A60 w/4" x 24" Light w/Glass LHR
	1	Pemko CFM79HD CLR Continuous Hinge
	1	Corbin Russwin DC 6210 M54 689 TRI PACK Door Closer
	1	Corbin Russwin CL3352 NZD 626 Intruder classroom w/ 0 Bitted Core
	1	Pemko 216 AV 36" Mill Finish Door Bottom
	1 Set	Pemko 303 AV 7284 Mill Finish Weather Stripping

Doors with Set #2:

218	227								
-----	-----	--	--	--	--	--	--	--	--

<b>Set # 3</b>	<b>Qt.</b>	<b>Description</b>
	-	Aluminum Jamb REMAINS, single door
	1	HMD 18 GA 1 3/4, 6-0 x 6-8 GALV, A60 w/4" x 24" Light w/Glass RHR
	1	Pemko CFM79HD CLR Continuous Hinge
	1	Corbin Russwin DC 6210 M54 689 TRI PACK Door Closer
	1	Corbin Russwin CL3352 NZD 626 Intruder classroom w/ 0 Bitted Core
	1	Pemko 216 AV 36" Mill Finish Door Bottom
	1 Set	Pemko 303 AV 7284 Mill Finish Weather Stripping

Doors with Set #3:

236									
-----	--	--	--	--	--	--	--	--	--

Set # 4	Qt.	Description
-		Steel Jamb REMAINS, 6' opening
1 Pair		HMD 18 GA 1 3/4, 6-0 x 7-0 GALV, A60 w/4" x 24" Light w/Glass RHR
2		Pemko CFM83HD CLR Continuous Hinge
1		Corbin Russwin CR 907 Mullion USP 84"
2		Corbin Russwin ED 5200 TH955ET M54 630 Rim Panic w/ 0 Bitted N4 Cylinder
2		Corbin Russwin DC 6210 M54 689 TRI PACK Door Closer
2		Pemko 216 AV 36" Mill Finish Door Bottom
1 Set		Pemko 303 AV 7284 Mill Finish Weather Stripping

Doors with Set #4:

516	516A	514	507A						
-----	------	-----	------	--	--	--	--	--	--

Set # 5	Qt.	Description
-		REMOVE & REPLACE Steel Jamb, 3' opening
1		Steelcraft F, 16GA, 4(1 3/4"), 5 3/4", 3-0 x 6-8, RH frame, CYL(2 3/4" strike prep), 3 hinge prep
1		HMD 18 GA 1 3/4, 3-0 x 6-8 GALV, A60, LHR 3 hinge prep
Set of 3		McKinney MPB, 4 1/2" x 4 1/2", US32D NRP full mortise butt hinge for exterior outswing doors
1		Corbin Russwin DC 6210 M54 689 TRI PACK Door Closer
1		Corbin Russwin CL3355 NZD 626 classroom w/ 0 Bitted Core
1		Pemko 271A 36" Mill Finish Threshold
1		Pemko 216 AV 36" Mill Finish Door Bottom

Doors with Set #5:

616									
-----	--	--	--	--	--	--	--	--	--

Set # 6	Qt.	Description
-		REMOVE & REPLACE Steel Jamb, 3' opening
1		Steelcraft F, 16GA, 4(1 3/4"), 5 3/4", 3-0 x 6-8, LH frame, CYL(2 3/4" strike prep), 3 hinge prep
1		HMD 18 GA 1 3/4, 3-0 x 6-8 GALV, A60, RHR 3 hinge prep
Set of 3		McKinney MPB, 4 1/2" x 4 1/2", US32D NRP full mortise butt hinge for exterior outswing doors
1		Corbin Russwin DC 6210 M54 689 TRI PACK Door Closer
1		Corbin Russwin CL3355 NZD 626 classroom w/ 0 Bitted Core
1		Pemko 271A 36" Mill Finish Threshold
1		Pemko 216 AV 36" Mill Finish Door Bottom

Doors with Set #6:

617									
-----	--	--	--	--	--	--	--	--	--

Set # 7	Qt.	Description
	-	REMOVE & REPLACE Wood Jamb, 6' opening
	1	Steelcraft F, 16GA, 4(1 3/4"), 5 3/4", 6-0 x 7-0, LH frame, CYL(2 3/4" strike prep), 6 hinge prep
	1 Pair	HMD 18 GA 1 3/4, 6-0 x 7-0 GALV, A60 w/4" x 24" Light w/Glass RHR
	Set of 6	McKinney MPB, 4 1/2" x 4 1/2", US32D NRP full mortise butt hinge for exterior outswing doors
	1	Corbin Russwin CR 907 Mullion USP 84"
	2	Corbin Russwin ED 5200 TH955ET M54 630 Rim Panic w/ 0 Bitted N4 Cylinder
	2	Corbin Russwin DC 6210 M54 689 TRI PACK Door Closer
	1	Pemko 271A 72" Mill Finish Threshold
	2	Pemko 216 AV 36" Mill Finish Door Bottom
	1 Set	Pemko 303 AV 7284 Mill Finish Weather Stripping

Doors with Set #7:

601	601A								
-----	------	--	--	--	--	--	--	--	--

Set # 8	Qt.	Description
	-	REMOVE & REPLACE Steel Jamb, 3' opening
	1	Steelcraft F, 16GA, 4(1 3/4"), 5 3/4", 3-0 x 6-8, RH frame, CYL(2 3/4" strike prep), 3 hinge prep
	1	HMD 18 GA 1 3/4, 3-0 x 6-8 GALV, A60, LHR 3 hinge prep
	Set of 3	McKinney MPB, 4 1/2" x 4 1/2", US32D NRP full mortise butt hinge for exterior outswing doors
	1	Corbin Russwin DC 6210 M54 689 TRI PACK Door Closer
	1	Corbin Russwin ED 5200 TH955ET M54 630 Rim Panic w/ 0 Bitted N4 Cylinder
	1	Pemko 216 AV 36" Mill Finish Door Bottom
	1	Pemko 271A 36" Mill Finish Threshold
	1 Set	Pemko 303 AV 7284 Mill Finish Weather Stripping

Doors with Set #8:

602									
-----	--	--	--	--	--	--	--	--	--

Set # 9	Qt.	Description
	-	REMOVE & REPLACE Steel Jamb, 3' opening
	1	Steelcraft F, 16GA, 4(1 3/4"), 5 3/4", 3-0 x 6-8, LH frame, CYL(2 3/4" strike prep), 3 hinge prep
	1	HMD 18 GA 1 3/4, 3-0 x 6-8 GALV, A60, RHR 3 hinge prep
	Set of 3	McKinney MPB, 4 1/2" x 4 1/2", US32D NRP full mortise butt hinge for exterior outswing doors
	1	Corbin Russwin DC 6210 M54 689 TRI PACK Door Closer
	1	Corbin Russwin ED 5200 TH955ET M54 630 Rim Panic w/ 0 Bitted N4 Cylinder
	1	Pemko 216 AV 36" Mill Finish Door Bottom
	1	Pemko 271A 36" Mill Finish Threshold
	1 Set	Pemko 303 AV 7284 Mill Finish Weather Stripping

Doors with Set #9:

603									
-----	--	--	--	--	--	--	--	--	--

End of Part Three