

WILMER ELEMENTARY SCHOOL

Mobile, Alabama

SPECIFICATIONS

PLAYGROUND EQUIPMENT AND INSTALLATION

BSC #23-22



AUGUST 23, 2023

**THE BOARD OF SCHOOL COMMISSIONERS
OF MOBILE COUNTY**

P. O. Box 180069

Mobile, AL 36618

Purchasing Dept. – 251/221-4473

NEW BUILDING ENTRANCE

FOR

“PURCHASING DEPARTMENT”

Please note the entrance to Building “E” (1 Magnum Pass) has changed. You will need to enter Building “E” as shown on the following diagram where you will be checked in by a security officer and then directed to the Purchasing Department.

Please allow sufficient time for this change if you are dropping off a bid on the same day as the bid closes. MCPSS will NOT be responsible for any late bids.



Mobile County
PUBLIC SCHOOLS

SCHILLINGERS ROAD

HOWELLS FERRY ROAD

MAGNUM PASS

ENTRANCE
TO BUILDING
"E"

PARKING

PURCHASING DEPT.
(BUILDING "E")

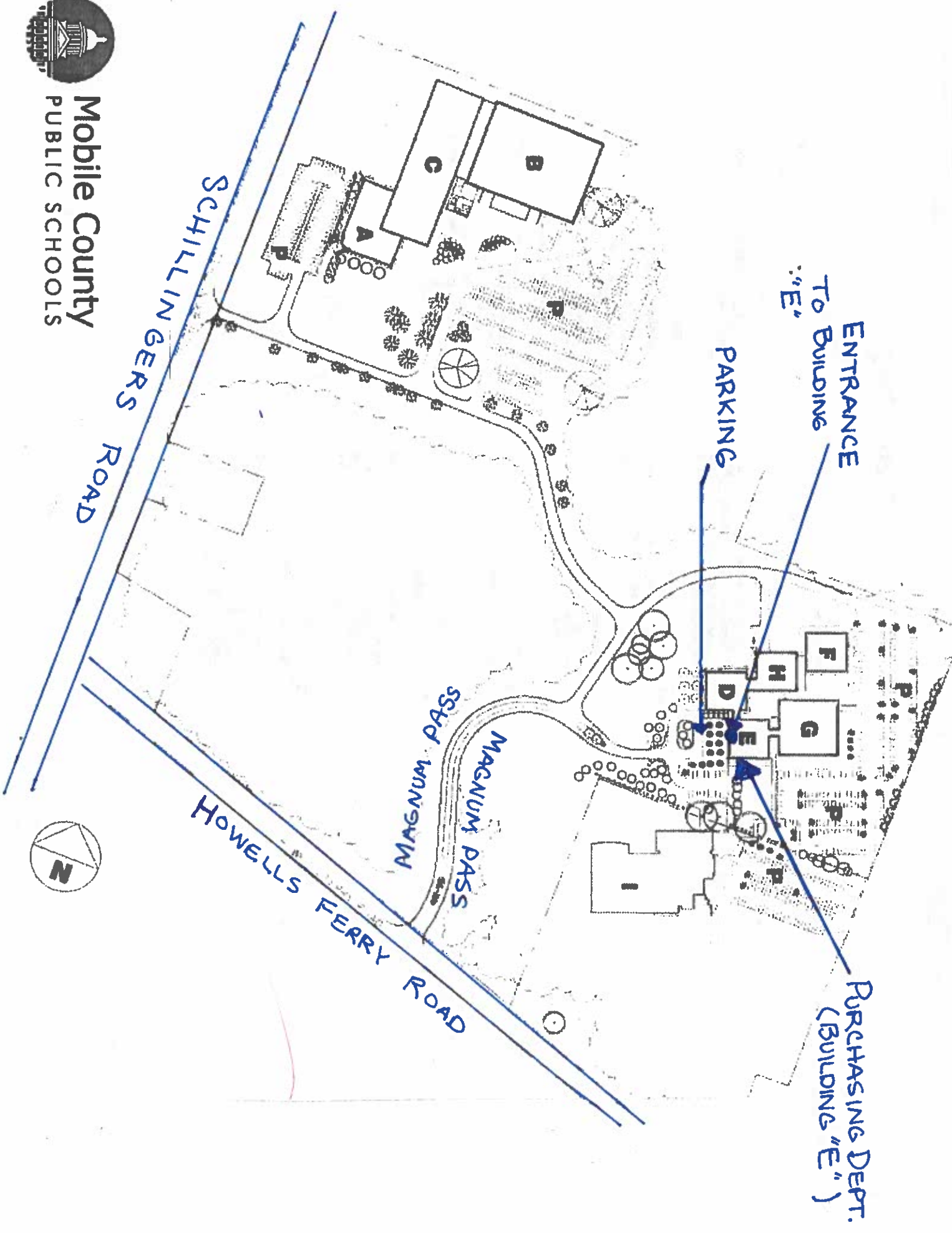

Directory

A Building A Student Services Building

Student Services 4245
 Health Services 4292
 Microcomputer Services 5142
 STI Off ice/Classroom Software Support 6201
 Hardware Support 6223
 Network Support 6222

B Building B

Professional Development 5200
 General Receiving/Distribution 5115
 Textbooks 5198
 JRCITC 5100
 Print Shop 6273
 Archives 4658
 Make & Take 5223
 Mail Services 3400

C Building C Environmental Services

4703

D Building D Executive Building

Office of the Superintendent 4304
 Chief Financial Office 4434
 Comptroller 4494
 Budget Office 4506
 Child Nutrition Program 4374

E Building E Business Building

Security Office 4108
 Purchasing 4473
 Accounting 4445
 Accounts Payable 4438
 Local School Accounting 4427

F Building F Facilities Office

4822

G Building G Human Resources Office, Payroll Office, TV Studio

4543
 4449
 3118

H Building H Technology Building

Information Technology Services 4525
 Instructional Technology 4210
 Office of Communications 8622

I Building I Academic Affairs Building

Board Offices & Board Meeting Room 4387
 Academic Affairs 4159
 Curriculum & Instruction 4141
 Federal Programs 5220
 Special Education 4220
 Career/Technical Education 4019
 Public Board Meetings

P Building - Public and Employees

LET'S LOAD THE BASES!

Miracle League of West Mobile: Schmidt Family Park



Our community is coming together to build baseball fields and a playground for children with special needs. The Miracle League of West Mobile: Schmidt Family Park will be constructed on Johnson Road, about two miles southwest of the intersection of Airport Boulevard and Snow Road.

You have the opportunity to help us create a miracle in Mobile County! If you hit a Single, Double, Triple, Home Run, or Grand Slam, you, your family, your business or your organization will be recognized at the park.

Several community organizations have already stepped up to the plate, donating land, providing funds to pave the road, and more. The key players thus far are: the Alabama Pecan Development Company, Inc., Schmidt-Barton Family Fund, South Alabama Utilities, Mobile County Public Schools and the Mobile County Commission. The Alabama Pecan Development Company, Inc., has donated more than 24 acres to the project and South Alabama Utilities has donated more than 4 acres. The Schmidt-Barton Family Fund is donating up to \$1 million in matching funds toward the estimated \$5 million in total construction costs.

Donations are now being accepted at mcpss.com/miracleleague to cover the remaining costs associated with the park.

Why should you donate?

Currently, many Mobile County youths with mental and physical disabilities are unable to play baseball in existing parks due to the lack of facilities that meet their needs. The Miracle League of West Mobile: Schmidt Family Park will be open to children from the entire county and surrounding areas. Approximately 8,300 children with disabilities would be able to play here.

Single

\$1,000-\$9,999

Double

\$10,000-\$49,000

Triple

\$50,000-\$99,999

Home Run

\$100,000-\$249,999

Grand Slam

\$250,000 +

**ALABAMA PECAN
DEVELOPMENT
CO. INC**

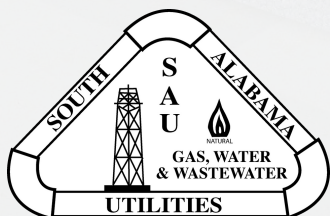

**Mobile County
PUBLIC SCHOOLS**

MIRACLE LEAGUE OF WEST MOBILE: SCHMIDT FAMILY PARK

MCPSS.COM/MIRACLELEAGUE

We are working directly with The Miracle League, which is based in Georgia and has 240 fields across the United States and in Puerto Rico and Canada, on this project. Why? So our children with mental and physical disabilities can experience the joy of America's favorite pastime. It's more than just a game. The Miracle League is about making new friends, building self-esteem and being treated just like other athletes.

The Miracle League baseball field will feature a synthetic rubberized turf that accommodates wheelchairs and other assistive devices while helping to prevent injuries. The field will have double-wide lanes, allowing the players more space as they round the bases. The park will also include a regular baseball field for children who are middle-school-aged. The hope is to one day build a school on the site to serve special-needs and autistic students.

This will be the first Miracle League field in Mobile County. The project will progress in phases as funding becomes available, with the Miracle Field and Playground as the major components of the first phase.

The first phase of the plan will cost approximately \$2.3 million. We still need to raise \$1 million to fund all facets of Phase 1, which we hope to complete in the fall of 2022.

Mobile County Public Schools is overseeing the financing of the project. We are applying for various grants and accepting donations at: mcpss.com/miracleleague.

We appreciate your support as we make a miracle happen in west Mobile!

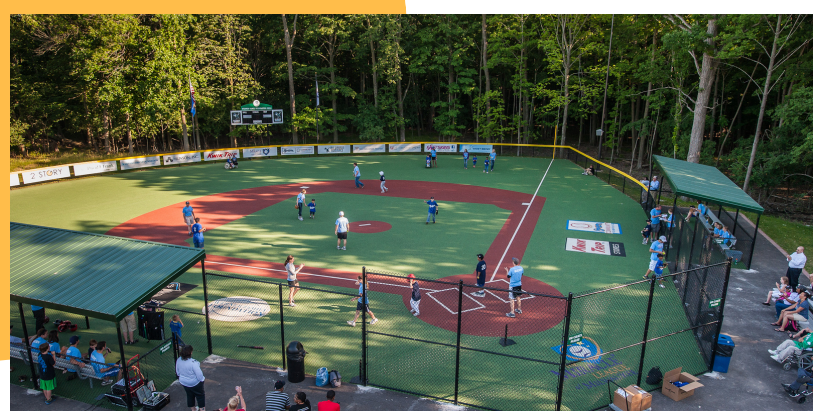

**Certification Regarding Debarment, Suspension, and Other
Responsibility Matters - Primary Covered Transactions**

This certification is required by the regulations implementing Executive Order 12549, Debarment and Suspension, 7 CFR Part 3017, Section 3017.510, Participants' responsibilities. The regulations were published as Part IV of the January 30, 1989, Federal Register (pages 1722-1733). Copies of the regulations may be obtained by contacting the Department of Agriculture agency offering the proposed covered transaction.

(BEFORE COMPLETING CERTIFICATION, READ INSTRUCTIONS ON REVERSE)

- (1) The prospective primary participant certifies to the best of its knowledge and belief, that it and its principals:
- (a) are not presently debarred, suspended, proposed for debarment, declared ineligible, or voluntarily excluded from covered transactions by any Federal department or agency;
 - (b) have not within a three-year period preceding this proposal been convicted of or had a civil judgment rendered against them for commission of fraud or a criminal offense in connection with obtaining, attempting to obtain, or performing a public (Federal, State or local) transaction or contract under a public transaction; violation of Federal or State antitrust statutes or commission of embezzlement, theft, forgery, bribery, falsification or destruction of records, making false statements, or receiving stolen property;
 - (c) are not presently indicted for or otherwise criminally or civilly charged by a governmental entity (Federal, State or local) with commission of any of the offenses enumerated in paragraph (1) (b) of this certification; and
 - (d) have not within a three-year period preceding this application/proposal had one or more public transactions (Federal, State or local) terminated for cause or default.
- (2) Where the prospective primary participant is unable to certify to any of the statements in this certification, such prospective participant shall attach an explanation to this proposal.

Organization Name

PR/Award Number of Project Name

Name(s) and Title(s) of Authorized Representative(s)

Signature(s)

Date

INSTRUCTIONS FOR CERTIFICATION

1. By signing and submitting this form, the prospective primary participant is providing the certification set out on the reverse side in accordance with these instructions.
2. The inability of a person to provide the certification required below will not necessarily result in denial of participation in this covered transaction. The prospective participant shall submit an explanation of why it cannot provide the certification set out on this form. The certification or explanation will be considered in connection with the department or agency's determination whether to enter into this transaction. However, failure of the prospective primary participant to furnish a certification or an explanation shall disqualify such person from participation in this transaction.
3. The certification in this clause is a material representation of fact upon which reliance was placed when the department or agency determined to enter into this transaction. If it is later determined that the prospective primary participant knowingly rendered an erroneous certification, in addition to other remedies available to the Federal Government, the department or agency may terminate this transaction for cause or default.
4. The prospective primary participant shall provide immediate written notice to the department or agency to whom this proposal is submitted if at any time the prospective primary participant learns that its certification was erroneous when submitted or has become erroneous by reasons of changed circumstances.
5. The terms "covered transaction," "debarred," "suspended," "ineligible," "lower tier covered transaction", "participant," "primary covered transaction," "principal," "proposal," and "voluntarily excluded," as used in this clause, have the meanings set out in the Definitions and Coverage sections of the rules implementing Executive Order 12549. You may contact the department or agency to which this proposal is being submitted for assistance in obtaining a copy of those regulations.
6. The prospective primary participant agrees by submitting this form that, should the proposed covered transaction be entered into, it shall not knowingly enter into any lower tier covered transaction with a person who is debarred, suspended, declared ineligible, or voluntarily excluded from participation in this covered transaction, unless authorized by the department or agency entering into this transaction.
7. The prospective primary participant further agrees by submitting this form that it will include the clause titled "Certification Regarding Debarment, Suspension, Ineligibility and Voluntary Exclusion - Lower Tier Covered Transactions," provided by the department or agency entering into this covered transaction, without modification, in all lower tier covered transactions and in all solicitations for lower tier covered transactions.
8. A participant in a covered transaction may rely upon a certification of a prospective participant in a lower tier covered transaction that it is not debarred, suspended, ineligible or voluntarily excluded from the covered transaction, unless it knows that the certification is erroneous. A participant may decide the method and frequency by which it determines the eligibility of its principals. Each participant may, but is not required to, check the Nonprocurement List.
9. Nothing contained in the foregoing shall be construed to require establishment of a system of records in order to render in good faith the certification required by this clause. The knowledge and information of a participant is not required to exceed that which is normally possessed by a prudent person in the ordinary course of business dealings.
10. Except for transactions authorized under paragraph 6 of these instructions, if a participant in a covered transaction knowingly enters into a lower tier covered transaction with a person who is suspended, debarred, ineligible, or voluntarily excluded from participation in this transaction, in addition to other remedies available to the Federal Government, the department or agency may terminate this transaction for cause or default.

REQUIRED FEDERAL PROVISIONS FOR PROCUREMENT IN CNP PROGRAMS

Title 2: Grants and Agreements

PART 200—UNIFORM ADMINISTRATIVE REQUIREMENTS, COST PRINCIPLES, AND AUDIT REQUIREMENTS FOR FEDERAL AWARDS

Subpart F—Audit Requirements Appendix II to Part 200—Contract Provisions for Non-Federal Entity Contracts Under Federal Awards

In addition to other provisions required by the Federal agency or non-Federal entity, all contracts made by the non-Federal entity under the Federal award must contain provisions covering the following, as applicable.

(A) Contracts for more than the simplified acquisition threshold currently set at \$150,000, which is the inflation adjusted amount determined by the Civilian Agency Acquisition Council and the Defense Acquisition Regulations Council (Councils) as authorized by 41 U.S.C. 1908, must address administrative, contractual, or legal remedies in instances where contractors violate or breach contract terms, and provide for such sanctions and penalties as appropriate.

(B) All contracts in excess of \$10,000 must address termination for cause and for convenience by the non-Federal entity including the manner by which it will be effected and the basis for settlement.

(C) Equal Employment Opportunity. Except as otherwise provided under 41 CFR Part 60, all contracts that meet the definition of “federally assisted construction contract” in 41 CFR Part 60-1.3 must include the equal opportunity clause provided under 41 CFR 60-1.4(b), in accordance with Executive Order 11246, “Equal Employment Opportunity” (30 FR 12319, 12935, 3 CFR Part, 1964-1965 Comp., p. 339), as amended by Executive Order 11375, “Amending Executive Order 11246 Relating to Equal Employment Opportunity,” and implementing regulations at 41 CFR part 60, “Office of Federal Contract Compliance Programs, Equal Employment Opportunity, Department of Labor.”

(D) Davis-Bacon Act, as amended (40 U.S.C. 3141-3148). When required by Federal program legislation, all prime construction contracts in excess of \$2,000 awarded by non-Federal entities must include a provision for compliance with the Davis-Bacon Act (40 U.S.C. 3141-3144, and 3146-3148) as supplemented by Department of Labor regulations (29 CFR Part 5, “Labor Standards Provisions Applicable to Contracts Covering Federally Financed and Assisted Construction”). In accordance with the statute, contractors must be required to pay wages to laborers and mechanics at a rate not less than the prevailing wages specified in a wage determination made by the Secretary of Labor. In addition, contractors must be required to pay wages not less than once a week. The non-Federal entity must place a copy of the current prevailing wage determination issued by the Department of Labor in each solicitation. The decision to award a contract or subcontract must be conditioned upon the acceptance of the wage determination. The non-Federal entity must report all suspected or reported violations to the Federal awarding agency. The contracts must also include a provision for compliance with the Copeland “Anti-Kickback” Act (40 U.S.C. 3145), as supplemented by Department of Labor regulations (29 CFR Part 3, “Contractors and Subcontractors on Public Building or Public Work Financed in Whole or in Part by Loans or Grants from the United States”). The Act provides that each contractor or subrecipient must be prohibited from inducing, by any means, any person employed in the construction, completion, or repair of public work, to give up any part of the compensation to which he or she is otherwise entitled. The non-Federal entity must report all suspected or reported violations to the Federal awarding agency.

(E) Contract Work Hours and Safety Standards Act (40 U.S.C. 3701-3708). Where applicable, all contracts awarded by the non-Federal entity in excess of \$100,000 that involve the employment of mechanics or laborers must include a provision for compliance with 40 U.S.C. 3702 and 3704, as supplemented by Department of Labor regulations (29 CFR Part 5). Under 40 U.S.C. 3702 of the Act, each contractor must be required to compute the wages of every mechanic and laborer on the basis of a standard work week of 40 hours. Work in excess of the standard work week is permissible provided that the worker is compensated at a rate of not less than one and a half times the basic rate of pay for all hours worked in excess of 40 hours in the work week. The requirements of 40 U.S.C. 3704 are applicable to construction work and provide that no laborer or mechanic must be required to work in surroundings or under working conditions which are unsanitary, hazardous or dangerous. These requirements do not apply to the purchases of supplies or materials or articles ordinarily available on the open market, or contracts for transportation or transmission of intelligence.

(F) Rights to Inventions Made Under a Contract or Agreement. If the Federal award meets the definition of “funding agreement” under 37 CFR §401.2 (a) and the recipient or subrecipient wishes to enter into a contract with a small business firm or nonprofit organization regarding the substitution of parties, assignment or performance of experimental, developmental, or research work under that “funding agreement,” the recipient or subrecipient must comply with the requirements of 37 CFR Part 401, “Rights to Inventions Made by Nonprofit Organizations and Small Business Firms Under Government Grants, Contracts and Cooperative Agreements,” and any implementing regulations issued by the awarding agency.

(G) Clean Air Act (42 U.S.C. 7401-7671q.) and the Federal Water Pollution Control Act (33 U.S.C. 1251-1387), as amended—Contracts and subgrants of amounts in excess of \$150,000 must contain a provision that requires the non-Federal award to agree to comply with all applicable standards, orders or regulations issued pursuant to the Clean Air Act (42 U.S.C. 7401-7671q) and the Federal Water Pollution Control Act as amended (33 U.S.C. 1251-1387). Violations must be reported to the Federal awarding agency and the Regional Office of the Environmental Protection Agency (EPA).

(H) Debarment and Suspension (Executive Orders 12549 and 12689)—A contract award (see 2 CFR 180.220) must not be made to parties listed on the governmentwide exclusions in the System for Award Management (SAM), in accordance with the OMB guidelines at 2 CFR 180 that implement Executive Orders 12549 (3 CFR part 1986 Comp., p. 189) and 12689 (3 CFR part 1989 Comp., p. 235), “Debarment and Suspension.” SAM Exclusions contains the names of parties debarred, suspended, or otherwise excluded by agencies, as well as parties declared ineligible under statutory or regulatory authority other than Executive Order 12549.

(I) Byrd Anti-Lobbying Amendment (31 U.S.C. 1352)—Contractors that apply or bid for an award exceeding \$100,000 must file the required certification. Each tier certifies to the tier above that it will not and has not used Federal appropriated funds to pay any person or organization for influencing or attempting to influence an officer or employee of any agency, a member of Congress, officer or employee of Congress, or an employee of a member of Congress in connection with obtaining any Federal contract, grant or any other award covered by 31 U.S.C. 1352. Each tier must also disclose any lobbying with non-Federal funds that takes place in connection with obtaining any Federal award. Such disclosures are forwarded from tier to tier up to the non-Federal award.

(J) See §200.322 Procurement of recovered materials. A non-Federal entity that is a state agency or agency of a political subdivision of a state and its contractors must comply with section 6002 of the Solid Waste Disposal Act, as amended by the Resource Conservation and Recovery Act. The requirements of Section 6002 include procuring only items designated in guidelines of the Environmental Protection Agency (EPA) at 40 CFR part 247 that contain the highest percentage of recovered materials practicable, consistent with maintaining a satisfactory level of competition, where the purchase price of the item exceeds \$10,000 or the value of the quantity acquired during the preceding fiscal year exceeded \$10,000; procuring solid waste management services in a manner that maximizes energy and resource recovery; and establishing an affirmative procurement program for procurement of recovered materials identified in the EPA guidelines.

REQUIRED FEDERAL PROVISIONS FOR PROCUREMENT IN CNP PROGRAMS

Title 7: Agriculture

PART 210—NATIONAL SCHOOL LUNCH PROGRAM

Subpart E—State Agency and School Food Authority Responsibilities §210.21 Procurement.

(d) Buy American—

(1) Definition of domestic commodity or product. In this paragraph (d), the term ‘domestic commodity or product’ means—

- (i) An agricultural commodity that is produced in the United States; and
- (ii) A food product that is processed in the United States substantially using agricultural commodities that are produced in the United States.

(2) Requirement.

(i) In general. Subject to paragraph (d)(2)(ii) of this section, the Department shall require that a school food authority purchase, to the maximum extent practicable, domestic commodities or products.

(ii) Limitations. Paragraph (d)(2)(i) of this section shall apply only to—

- (A) A school food authority located in the contiguous United States; and
- (B) A purchase of domestic commodity or product for the school lunch program under this part.

(f) Cost reimbursable contracts—

(1) Required provisions. The school food authority must include the following provisions in all cost reimbursable contracts, including contracts with cost reimbursable provisions, and in solicitation documents prepared to obtain offers for such contracts:

(i) Allowable costs will be paid from the nonprofit school food service account to the contractor net of all discounts, rebates and other applicable credits accruing to or received by the contractor or any assignee under the contract, to the extent those credits are allocable to the allowable portion of the costs billed to the school food authority;

(ii) (A) The contractor must separately identify for each cost submitted for payment to the school food authority the amount of that cost that is allowable (can be paid from the nonprofit school food service account) and the amount that is unallowable (cannot be paid from the nonprofit school food service account); or

(B) The contractor must exclude all unallowable costs from its billing documents and certify that only allowable costs are submitted for payment and records have been established that maintain the visibility of unallowable costs, including directly associated costs in a manner suitable for contract cost determination and verification;

(iii) The contractor's determination of its allowable costs must be made in compliance with the applicable Departmental and Program regulations and Office of Management and Budget cost circulars;

(iv) The contractor must identify the amount of each discount, rebate and other applicable credit on bills and invoices presented to the school food authority for payment and individually identify the amount as a discount, rebate, or in the case of other applicable credits, the nature of the credit. If approved by the State agency, the school food authority may permit the contractor to report this information on a less frequent basis than monthly, but no less frequently than annually;

(v) The contractor must identify the method by which it will report discounts, rebates and other applicable credits allocable to the contract that are not reported prior to conclusion of the contract; and

(vi) The contractor must maintain documentation of costs and discounts, rebates and other applicable credits, and must furnish such documentation upon request to the school food authority, the State agency, or the Department.

(2) Prohibited expenditures. No expenditure may be made from the nonprofit school food service account for any cost resulting from a cost reimbursable contract that fails to include the requirements of this section, nor may any expenditure be made from the nonprofit school food service account that permits or results in the contractor receiving payments in excess of the contractor's actual, net allowable costs.

(g) Geographic preference.

(1) A school food authority participating in the Program, as well as State agencies making purchases on behalf of such school food authorities, may apply a geographic preference when procuring unprocessed locally grown or locally raised agricultural products. When utilizing the geographic preference to procure such products, the school food authority making the purchase or the State agency making purchases on behalf of such school food authorities have the discretion to determine the local area to which the geographic preference option will be applied;

(2) For the purpose of applying the optional geographic procurement preference in paragraph (g)(1) of this section, “unprocessed locally grown or locally raised agricultural products” means only those agricultural products that retain their inherent character. The effects of the following food handling and preservation techniques shall not be considered as changing an agricultural product into a product of a different kind or character: Cooling; refrigerating; freezing; size adjustment made by peeling, slicing, dicing, cutting, chopping, shucking, and grinding; forming ground products into patties without any additives or fillers; drying/dehydration; washing; packaging (such as placing eggs in cartons), vacuum packing and bagging (such as placing vegetables in bags or combining two or more types of vegetables or fruits in a single package); the addition of ascorbic acid or other preservatives to prevent oxidation of produce; butchering livestock and poultry; cleaning fish; and the pasteurization of milk.

In accordance with Federal civil rights law and U.S. Department of Agriculture (USDA) civil rights regulations and policies, the USDA, its Agencies, offices, and employees, and institutions participating in or administering USDA programs are prohibited from discriminating based on race, color, national origin, sex, disability, age, or reprisal or retaliation for prior civil rights activity in any program or activity conducted or funded by USDA.

Persons with disabilities who require alternative means of communication for program information (e.g. Braille, large print, audiotope, American Sign Language, etc.), should contact the Agency (State or local) where they applied for benefits. Individuals who are deaf, hard of hearing or have speech disabilities may contact USDA through the Federal Relay Service at (800) 877-8339. Additionally, program information may be made available in languages other than English.

To file a program complaint of discrimination, complete the USDA Program Discrimination Complaint Form, (AD-3027) found online at: http://www.ascr.usda.gov/complaint_filing_cust.html, and at any USDA office, or write a letter addressed to USDA and provide in the letter all of the information requested in the form. To request a copy of the complaint form, call (866) 632-9992. Submit your completed form or letter to USDA by:

(1) mail: U.S. Department of Agriculture
Office of the Assistant Secretary for Civil Rights
1400 Independence Avenue, SW
Washington, D.C. 20250-9410;

(2) fax: (202) 690-7442; or

(3) email: program.intake@usda.gov.

This institution is an equal opportunity provider.

WILMER ELEMENTARY SCHOOL

Wilmer, AL

PLAYGROUND EQUIPMENT AND INSTALLATION

BSC #23-22

TABLE OF CONTENTS

	<u>No. of Pages</u>
DCM Form C-1 - ADVERTISEMENT FOR BIDS.....	1
DCM Form C-2 - INSTRUCTIONS TO BIDDERS.....	9
DCM Form C-3 - PROPOSAL FORM.....	2
DCM Form C-3A - ACCOUNTING OF SALES TAX (Attachment to DCM Form C-3).....	6
DCM Form C-4 - FORM OF BID BOND.....	1
- VENDOR MINORITY QUESTIONNAIRE.....	1
- IMMIGRATION LAW COMPLIANCE DOCUMENT.....	1
- AOC/REGIONS BANK VENDOR ENROLLMENT FORM.....	2
- CONTRACTORS STATEMENT.....	1
- COVENANT AGAINST CONTINGENT FEES.....	1
- LIST OF SUBCONTRACTORS.....	1
- DISCLOSURE STATEMENT.....	2
- SPECIAL NOTICE.....	1
DCM Form C-5 - CONSTRUCTION CONTRACT.....	2
DCM Form C-6 - PERFORMANCE BOND.....	3
DCM Form C-7 - PAYMENT BOND.....	2
DCM Form C-8 - GENERAL CONDITIONS OF THE CONTRACT FOR CONSTRUCTION	54
DCM Form C-8 - EXCERPT FROM DCM FORM C-8.....	4
DCM Form C-10 - APPLICATION AND CERTIFICATE FOR PAYMENT.....	1
DCM Form C10SM - INVENTORY OF STORED MATERIALS.....	1
DCM Form C10SOV - SCHEDULE OF VALUES.....	1
DCM Form C-11 - PROGRESS SCHEDULE REPORT.....	1
DCM Form B-11 - CHANGE ORDER JUSTIFICATION.....	2
DCM Form C-12 - CONTRACT CHANGE ORDER.....	2
DCM Form C-13 - CERTIFICATE OF SUBSTANTIAL COMPLETION.....	2
DCM Form C-14 - FORM OF ADVERTISEMENT FOR COMPLETION.....	1
DCM Form C-15 - DETAIL OF PROJECT SIGN.....	1
DCM Form C-18 - CONTRACTOR'S AFFIDAVIT PAYMENT OF DEBTS AND CLAIMS	1
DCM Form C-19 - CONTRACTOR'S AFFIDAVIT OF RELEASE OF LIENS.....	1
DCM Form C-20 - CONSENT OF SURETY TO FINAL PAYMENT.....	1
<hr/>	
- SPECIFICATIONS	8
- DRAWINGS	5

ADVERTISEMENT FOR BIDS

Sealed proposals will be received by the Board of School Commissioners of Mobile, County at the Purchasing Department, 1 Magnum Pass, Mobile, AL 36618 until **Wednesday, September 27, 2023 @ 2:00 P.M.** for

**WILMER ELEMENTARY SCHOOL
PLAYGROUND EQUIPMENT AND INSTALLATION
BSC #23-22**

at which time and place they will be publicly opened and read.

A cashier's check or bid bond payable to the Board of School Commissioners of Mobile County in an amount not less than five (5) percent of the amount of the bid, but in no event more than \$10,000, must accompany the bidder's proposal. Performance and Payment Bonds and evidence of insurance required in the bid documents will be required at the signing of the Contract.

Drawings and specifications may be downloaded at our website: www.mcps.com; F. W. Dodge Plan Rooms in Montgomery and Birmingham; CMD Group, Attn: Document Processing Center, 30 Technology Parkway South, Suite 500, Norcross, GA 30092-21912; and through SCAN.

A MANDATORY PRE-BID MEETING is scheduled to be held at approximately **10:00 A.M.** on **Tuesday, September 19, 2023 @ Wilmer Elementary School, 7456 Wilmer Georgetown Road, Wilmer, AL 36587.** Mandatory attendance is required for **all** prospective bidders. **No bid will be accepted from any bidder who is not represented at the pre-bid meeting.** It is the bidder's responsibility to register his/her attendance at the pre-bid meeting.

Bid Documents will be available for purchase from the OWNER at a non-refundable cost of **\$-N/A-** per set.

Bids must be submitted on proposal forms furnished by the Board of School Commissioners of Mobile County or copies thereof. All bidders bidding in amounts exceeding that established by the State Licensing Board for General Contractors must be licensed under the Provision of Title 34, Chapter 8, Code of Alabama, 1975, AND MUST SHOW EVIDENCE OF LICENSE BEFORE BIDDING OR BID WILL NOT BE RECEIVED OR CONSIDERED BY THE OWNER; THE BIDDER SHALL SHOW SUCH EVIDENCE BY CLEARLY DISPLAYING HIS OR HER CURRENT LICENSE NUMBER ON THE OUTSIDE OF THE SEALED ENVELOPE IN WHICH THE PROPOSAL IS DELIVERED. No bid may be withdrawn after the scheduled closing time for receipt of bids for a period of thirty (30) days. The Owner reserves the right to reject any or all proposals and to waive technical errors if, in the Owner's judgment, the best interests of the Owner will thereby be promoted.

BOARD OF SCHOOL COMMISSIONERS OF MOBILE COUNTY

RUSSELL HUDSON, Purchasing Director

NOTE: For projects exceeding \$50,000, this notice must be run once a week for three successive weeks in a newspaper of general circulation in the county or counties in which the project, or any part of the project, is to be performed. If the project involves an estimated amount exceeding \$500,000, this notice must also be run at least once in three newspapers of general circulation throughout the state. Proof of publication is required.

INSTRUCTIONS TO BIDDERS

CONTENTS

1. Bid Documents
2. General Contractor's State Licensing Requirements
3. Qualifications of Bidders and Prequalification Procedures
4. Preference to Resident Contractors
5. Examination of Bid Documents and the Site of the Work
6. Explanations and Interpretations
7. Substitutions
8. Preparation and Delivery of Bids
9. Withdrawal or Revision of Bids
10. Opening of Bids
11. Incomplete and Irregular Bids
12. Bid Errors
13. Disqualification of Bidders
14. Consideration of Bids
15. Determination of Low Bidder by Use of Alternates
16. Unit Prices
17. Award of Contract

1. BID DOCUMENTS:

The Bid Documents consist of the Advertisement for Bids, these Instructions to Bidders, any supplements to these Instructions to Bidders, the Proposal Form and the Accounting of Sales Tax, and the proposed Contract Documents. The proposed Contract Documents consist of the Construction Contract, the Performance Bond and Payment Bond, the Conditions of the Contract (General, Supplemental, and other Conditions), Drawings, Specifications and all addenda issued prior to execution of the Construction Contract. Bid Documents may be obtained or examined as set forth in the Advertisement for Bids.

2. GENERAL CONTRACTOR'S STATE LICENSING REQUIREMENTS:

When the amount bid for a contract exceeds \$50,000, the bidder must be licensed by the State Licensing Board for General Contractors and must show the Architect evidence of license before bidding or the bid will not be received by the Architect or considered by the Awarding Authority. A bid exceeding the bid limit stipulated in the bidder's license, or which is for work outside of the type or types of work stipulated in the bidder's license, will not be considered. In case of a joint venture of two or more contractors, the amount of the bid shall be within the maximum bid limitation as set by the State Licensing Board for General Contractors of the combined limitations of the partners to the joint venture.

3. QUALIFICATIONS of BIDDERS and PREQUALIFICATION PROCEDURES:

a. Any special qualifications required of general contractors, subcontractors, material suppliers, or fabricators are set forth in the Bid Documents.

b. The Awarding Authority may have elected to prequalify bidders. Parties interested in bidding for this contract are directed to the Advertisement for Bids and Supplemental Instructions to Bidders to determine whether bidders must be prequalified and how they may obtain copies of the Awarding Authority's published prequalification procedures and criteria.

c. Release of Bid Documents by the Architect to a prospective bidder will not constitute any determination by the Awarding Authority or Architect that the bidder has been found to be qualified, prequalified, or responsible.

4. PREFERENCE to RESIDENT CONTRACTORS:

(If this project is federally funded in whole or in part, this Article shall not apply.)

a. In awarding the Contract, preference will be given to Alabama resident contractors and a nonresident bidder domiciled in a state having laws granting preference to local contractors shall be awarded the Contract only on the same basis as the nonresident bidder's state awards contracts to Alabama contractors bidding under similar circumstances.

b. A nonresident bidder is a contractor which is neither organized and existing under the laws of the State of Alabama, nor maintains its principal place of business in the State of Alabama. A nonresident contractor which has maintained a permanent office within the State of Alabama for at least five continuous years shall not thereafter be deemed to be a non-resident contractor so long as the contractor continues to maintain a branch office within Alabama.

5. EXAMINATION of BID DOCUMENTS and the SITE of the WORK:

Before submitting a bid for the Work, the bidders shall carefully examine the Bid Documents, visit the site, and satisfy themselves as to the nature and location of the Work, and the general and local conditions, including weather, the general character of the site or building, the character and extent of existing work within or adjacent to the site and any other work being performed thereon at the time of submission of their bids. They shall obtain full knowledge as to transportation, disposal, handling, and storage of materials, availability of water, electric power, and all other facilities in the area which will have a bearing on the performance of the Work for which they submit their bids. The submission of a bid shall constitute a representation by the bidder that the bidder has made such examination and visit and has judged for and satisfied himself or herself as to conditions to be encountered regarding the character, difficulties, quality, and quantities of work to be performed and the material and equipment to be furnished, and as to the contract requirements involved.

6. EXPLANATIONS and INTERPRETATIONS:

a. Should any bidder observe any ambiguity, discrepancy, omission, or error in the drawings and specifications, or in any other bid document, or be in doubt as to the intention and meaning of these documents, the bidder should immediately report such to the Architect and request clarification.

b. Clarification will be made only by written Addenda sent to all prospective bidders. Neither the Architect nor the Awarding Authority will be responsible in any manner for verbal answers or instructions regarding intent or meaning of the Bid Documents.

c. In the case of inconsistency between drawings and specifications or within either document, a bidder will be deemed to have included in its bid the better quality or greater quantity of the work involved unless the bidder asked for and obtained the Architect's written clarification of the requirements before submission of a bid.

7. SUBSTITUTIONS:

a. The identification of any product, material, system, item of equipment, or service in the Bid Documents by reference to a trade name, manufacturer's name, model number, etc. (hereinafter referred to as "source"), is intended to establish a required standard of performance, design, and quality and is not intended to limit competition unless the provisions of paragraph "d" below apply.

b. When the Bid Documents identify only one or two sources, or three or more sources followed by "or approved equal" or similar wording, the bidder's proposal may be based on a source not identified but considered by the bidder to be equal to the standard of performance, design and quality as specified; however, such substitutions must ultimately be approved by the Architect. If the bidder elects to bid on a substitution without "Pre-bid Approval" as described below, then it will be understood that proof of compliance with specified requirements is the exclusive responsibility of the bidder.

c. When the Bid Documents identify three or more sources and the list of sources is not followed by "or approved equal" or similar wording, the bidder's proposal shall be based upon one of the identified sources, unless the bidder obtains "Pre-bid Approval" of another source as described below. Under these conditions it will be expressly understood that no product, material, system, item of equipment, or service that is not identified in the Bid Documents or granted "Pre-Bid Approval" will be incorporated into the Work unless such substitution is authorized and agreed upon through a Contract Change Order.

d. If the Bid Documents identify only one source and expressly provide that it is an approved sole source for the product, material, system, item of equipment, or service, the bidder's proposal must be based upon the identified sole source.

e. Procedures for "Pre-bid Approval". If it is desired that a product, material, system, piece of equipment, or service from a source different from those sources identified in the Bid Documents be approved as an acceptable source, application for the approval of such source must reach the hands of the Architect at least ten days prior to the date set for the opening of bids. At the Architect's discretion, this ten day provision may be waived. The application for approval of a proposed source must be accompanied by technical data which the applicant desires to submit in support of the application. The Architect will give consideration to reports from reputable independent testing laboratories, verified experience records showing the reputation of the proposed source with previous users, evidence of reputation of the source for prompt delivery, evidence of reputation of the source for efficiency in servicing its products, or any other pertinent written information. The application to the Architect for approval of a proposed source must be accompanied by a schedule setting forth in which respects the materials or equipment submitted for consideration differ from the materials or equipment designated in the Bid Documents. The burden of proof of the merit of the proposed substitution is upon the proposer. To be approved, a proposed source must also meet or exceed all express requirements of the Bid Documents. Approval, if granted, shall not be effective until published by the Architect in an addendum to the Bid Documents.

8. PREPARATION and DELIVERY of BIDS:

a. DCM Form C-3: Proposal Form:

- (1) Bids must be submitted on the Proposal Form as contained in the Bid Documents; only one copy is required to be submitted. A completed DCM Form C-3A: Accounting of Sales Tax must be submitted with the Proposal Form.
- (2) All information requested of the bidder on the Proposal Form must be filled in. The form must be completed by typewriter or hand-printed in ink.
- (3) Identification of Bidder: On the first page of the Proposal Form the bidder must be fully identified by completing the spaces provided for:
 - (a) the legal name of the bidder,
 - (b) the state under which laws the bidder's business is organized and existing,
 - (c) the city (and state) in which the bidder has its principal offices,
 - (d) the bidder's business organization, i.e., corporation, partnership, or individual (to be indicated by marking the applicable box and writing in the type of organization if it is not one of those listed), and
 - (e) the partners or officers of the bidder's organization, if the bidder is other than an individual. If the space provided on the Proposal Form is not adequate for this listing, the bidder may insert "See Attachment" in this space and provide the listing on an attachment to the Proposal Form.
- (4) Where indicated by the format of the Proposal Form, the bidder must specify lump sum prices in both words and figures. In case of discrepancy between the prices shown in words and in figures, the words will govern.
- (5) All bid items requested in the Proposal Form, including alternate bid prices and unit prices for separate items of the Work, must be bid. If a gross sum of bid items is requested in the Proposal Form, the gross sum shall be provided by the bidder.
- (6) In the space provided in the Proposal Form under "Bidder's Alabama License", the bidder must insert his or her current general contractor's state license number, current bid limit, and type(s) of work for which bidder is licensed.
- (7) The Proposal Form shall be properly signed by the bidder. If the bidder is:
 - (a) **an individual**, that individual or his or her "authorized representative" must sign the Proposal Form;
 - (b) **a partnership**, the Proposal Form must be signed by one of the partners or an "authorized representative" of the Partnership;
 - (c) **a corporation**, the president, vice-president, secretary, or "authorized representative" of the corporation shall sign and affix the corporate seal to the Proposal Form.

As used in these Instructions to Bidders, "authorized representative" is defined as a person to whom the bidder has granted written authority to conduct business in the bidder's behalf by signing and/or modifying the bid. Such written authority shall be signed by the bidder (the individual proprietor, or a member of the Partnership, or an officer of the Corporation) and shall be attached to the Proposal Form.

(8) Interlineation, alterations or erasures on the Proposal Form must be initialed by the bidder or its “authorized representative”.

b. DCM Form C-3A: Accounting of Sales Tax

A completed DCM Form C-3A: Accounting of Sales Tax must be submitted with DCM Form C-3: Proposal Form. Submission of DCM Form C-3A is required, it is not optional. A proposal shall be rendered non-responsive if an Accounting of Sales Tax is not provided.

c. Bid Guaranty

(1) The Proposal Form must be accompanied by a cashier’s check, drawn on an Alabama bank, or a Bid Bond, executed by a surety company duly authorized and qualified to make such bonds in the State of Alabama, payable to the Awarding Authority.

(2) If a Bid Bond is provided in lieu of a cashier’s check, the bond shall be on the Bid Bond form as stipulated in the Bid Documents.

(3) The amount of the cashier’s check or Bid Bond shall not be less than five percent of the contractor’s bid, but is not required to be in an amount more than ten thousand dollars.

d. Delivery of Bids:

(1) Bids will be received until the time set, and at the location designated, in the Advertisement for Bids unless notice is given of postponement. Any bid not received prior to the time set for opening bids will be rejected absent extenuating circumstances and such bids shall be rejected in all cases where received after other bids are opened.

(2) Each bid shall be placed, together with the bid guaranty, in a sealed envelope. On the outside of the envelope the bidder shall write in large letters “Proposal”, below which the bidder shall identify the Project and the Work bid on, the name of the bidder, and the bidder’s current general contractor’s state license number.

(3) Bids may be delivered in person, or by mail if ample time is allowed for delivery. When sent by mail, the sealed envelope containing the bid, marked as indicated above, shall be enclosed in another envelope for mailing.

9. WITHDRAWAL or REVISION of BIDS:

a. A bid may be withdrawn prior to the time set for opening of bids, provided a written request, executed by the bidder or the bidder’s “authorized representative”, is filed with the Architect prior to that time. The bid will then be returned to the bidder unopened.

b. A bid which has been sealed in its delivery envelope may be revised by writing the change in price on the outside of the delivery envelope over the signature of the bidder or the bidder’s “authorized representative”. In revising the bid in this manner, the bidder must only write the amount of the change in price on the envelope **and must not reveal the bid price.**

c. Written communications, signed by the bidder or its “authorized representative”, to revise bids will be accepted if received by the Architect prior to the time set for opening bids. The Architect will record the instructed revision upon opening the bid. Such written communication may be by facsimile if so stipulated in Supplemental Instructions to Bidders. In revising the bid in this manner, the bidder must only write the amount of the change in price **and must not reveal the bid price.**

d. Except as provided in Article 12 of these Instructions to Bidders, no bid shall be withdrawn, modified, or corrected after the time set for opening bids.

10. OPENING of BIDS:

a. Bids will be opened and read publicly at the time and place indicated in the Advertisement for Bids. Bidders or their authorized representatives are invited to be present.

b. A list of all proposed major subcontractors and suppliers will be submitted by Bidders to the Architect at a time subsequent to the receipt of bids as established by the Architect in the Bid Documents but in no event shall this time exceed twenty-four (24) hours after receipt of bids. If the list includes a fire alarm contractor and/or fire sprinkler contractor, Bidders will also submit a copy of the fire alarm contractor’s and/or fire sprinkler contractor’s permits from the State of Alabama Fire Marshal’s Office.

11. INCOMPLETE and IRREGULAR BIDS:

A bid that is not accompanied by data required by the Bid Documents, or a bid which is in any way incomplete, may be rejected. Any bid which contains any uninitialed alterations or erasures, or any bid which contains any additions, alternate bids, or conditions not called for, or any other irregularities of any kind, will be subject to rejection.

12. BID ERRORS:

a. **Errors and Discrepancies in the Proposal Form.** In case of error in the extension of prices in bids, the unit price will govern. In case of discrepancy between the prices shown in the figures and in words, the words will govern.

b. **Mistakes within the Bid.** If the low bidder discovers a mistake in its bid, the low bidder may seek withdrawal of its bid without forfeiture of its bid guaranty under the following conditions:

(1) **Timely Notice:** The low bidder must notify the Awarding Authority and Architect in writing, within three working days after the opening of bids, that a mistake was made. This notice must be given within this time frame whether or not award has been made.

(2) **Substantial Mistake:** The mistake must be of such significance as to render the bid price substantially out of proportion to the other bid prices.

(3) **Type of Mistake:** The mistake must be due to calculation or clerical error, an inadvertent omission, or a typographical error which results in an erroneous sum. A mistake of law, judgment, or opinion shall not constitute a valid ground for withdrawal without forfeiture.

(4) Documentary Evidence: Clear and convincing documentary evidence of the mistake must be presented to the Awarding Authority and the Architect as soon as possible, but no later than three working days after the opening of bids.

The Awarding Authority's decision regarding a low bidder's request to withdraw its bid without penalty shall be made within 10 days after receipt of the bidder's evidence or by the next regular meeting of the Awarding Authority. Upon withdrawal of bid without penalty, the low bidder shall be prohibited from (1) doing work on the project as a subcontractor or in any other capacity and (2) bidding on the same project if it is re-bid.

13. DISQUALIFICATION of BIDDERS:

Any bidder(s) may be disqualified from consideration for contract award for the following reasons:

a. Collusion. Any agreement or collusion among bidders or prospective bidders in restraint of freedom of competition to bid at a fixed price or to refrain from bidding or otherwise shall render the bids void and shall cause the bidders or prospective bidders participating in such agreement or collusion to be disqualified from submitting further bids to the Awarding Authority on future lettings. (See § 39-2-6, Code of Alabama 1975, for possible criminal sanctions.)

b. Advance Disclosure. Any disclosure in advance of the terms of a bid submitted in response to an Advertisement for Bids shall render the proceedings void and require re-advertisement and rebid.

c. Failure to Settle Other Contracts. The Awarding Authority may reject a bid from a bidder who has not paid, or satisfactorily settled, all bills due for labor and material on other contracts in force at the time of letting.

14. CONSIDERATION of BIDS:

a. After the bids are opened and read publicly, the bid prices will be compared and the results of this comparison will be available to the public. Until the final award of the contract, however, the Awarding Authority shall have the right to reject any or all bids, and it shall have the right to waive technical errors and irregularities if, in its judgment, the bidder will not have obtained a competitive advantage and the best interests of the Awarding Authority will be promoted.

b. If the Bid Documents request bids for projects or parts of projects in combination or separately, the Bid Documents must include supplements to, these Instructions to Bidders setting forth applicable bid procedures. Award or awards will be made to the lowest responsible and responsive bidder or bidders in accordance with such bid procedures.

15. DETERMINATION of LOW BIDDER by USE of ALTERNATES:

a. The Awarding Authority may request alternate bid prices (alternates) to facilitate either reducing the base bid to an amount within the funds available for the project or adding items to the base bid within the funds available for the project. Alternates, if any, are listed in the

Proposal Form in the order in which they shall cumulatively deduct from or add to the base bid for determining the lowest bidder.

b. If alternates are included in the Proposal Form, the Awarding Authority shall determine the dollar amount of funds available and immediately prior to the opening of bids shall announce publicly the funds available for the project. The dollar amount of such funds shall be used to determine the lowest bidder as provided herein below, notwithstanding that the actual funds available for the project may subsequently be determined to be more or less than the expected funds available as determined immediately prior to the time of the opening of bids.

c. If the base bid of the lowest bidder exceeds the funds available and alternate bid prices will reduce the base bids to an amount that is within the funds available, the lowest bidder will be determined by considering, in order, the fewest number of the alternates that produces a price within the funds available. If the base bid of the lowest bidder is within the funds available and alternate bid prices will permit adding items to the base bid, the lowest bidder will be determined by considering, in order, the greatest number of the alternates that produces a price within the funds available.

d. After the lowest bidder has been determined as set forth above, the Awarding Authority may award that bidder any combination of alternates, provided said bidder is also the low bidder when only the Base Bid and such combination of alternates are considered.

16. UNIT PRICES:

a. Work Bid on a Unit Price Basis. Where all, or part(s), of the planned Work is bid on a unit price basis, both the unit prices and the extensions of the unit prices constitute a basis of determining the lowest responsible and responsive bidder. In cases of error in the extension of prices of bids, the unit price will govern. A bid may be rejected if any of the unit prices are obviously unbalanced or non-competitive.

b. Unit Prices for Application to Change Orders. As a means of predetermining unit costs for changes in certain elements of the Work, the Bid Documents may require that the bidders furnish unit prices for those items in the Proposal Form. Unit prices for application to changes in the work are not a basis for determining the lowest bidder. Non-competitive unit prices proposed by the successful bidder may be rejected and competitive prices negotiated by the Awarding Authority prior to contract award. Unit prices for application to changes in the work are not effective unless specifically included and agreed upon in the Construction Contract.

17. AWARD of CONTRACT:

a. The contract shall be awarded to the lowest responsible and responsive bidder unless the Awarding Authority finds that all the bids are unreasonable or that it is not in the best interest of the Awarding Authority to accept any of the bids. A responsible bidder is one who, among other qualities determined necessary for performance, is competent, experienced, and financially able to perform the contract. A responsive bidder is one who submits a bid that complies with the terms and conditions of the Advertisement for Bids and the Bid Documents. Minor irregularities in the bid shall not defeat responsiveness.

b. A bidder to whom award is made will be notified by telegram, confirmed facsimile, or letter to the address shown on the Proposal Form at the earliest possible date. Unless other

time frames are stipulated in Supplemental Instructions to Bidders, the maximum time frames allowed for each step of the process between the opening of bids and the issuance of an order to proceed with the work shall be as follows:

(1) Award of contract by Awarding Authority	30 calendar days after the opening of bids
(2) Contractor's return of the fully executed contract, with bonds and evidence of insurance, to the Awarding Authority	15 calendar days after the contract has been presented to the contractor for signature (from the Lead Design Professional)
(3) Awarding Authority's approval of the contractor's bonds and evidence of insurance and completion of contract execution	20 calendar days after the contractor presents complete and acceptable documents to the Architect
(4) Notice To Proceed issued to the contractor along with distribution of the fully executed construction contract to all parties.	15 calendar days after final execution of contract by the Awarding Authority, by various State Agencies if required and by the Governor if his or her signature on the contract is required by law

The time frames stated above, or as otherwise specified in the Bid Documents, may be extended by written agreement between the parties. Failure by the Awarding Authority to comply with the time frames stated above or stipulated in Supplemental Instructions to Bidders, or agreed extensions thereof, shall be just cause for the withdrawal of the contractor's bid and contract without forfeiture of bid security.

c. Should the successful bidder or bidders to whom the contract is awarded fail to execute the Construction Contract and furnish acceptable Performance and Payment Bonds and satisfactory evidence of insurance within the specified period, the Awarding Authority shall retain from the bid guaranty, if it is a cashier's check, or recover from the principal or the sureties, if the guaranty is a bid bond, the difference between the amount of the contract as awarded and the amount of the bid of the next lowest responsible and responsive bidder, but not more than \$10,000. If no other bids are received, the full amount of the bid guaranty shall be so retained or recovered as liquidated damages for such default. Any sums so retained or recovered shall be the property of the Awarding Authority.

d. All bid guaranties, except those of the three lowest bona fide bidders, will be returned immediately after bids have been checked, tabulated, and the relation of the bids established. The bid guaranties of the three lowest bidders will be returned as soon as the contract bonds and the contract of the successful bidder have been properly executed and approved. When the award is deferred for a period of time longer than 15 days after the opening of the bids, all bid guaranties, except those of the potentially successful bidders, shall be returned. If no award is made within the specified period, as it may by agreement be extended, all bids will be rejected, and all guaranties returned. If any potentially successful bidder agrees in writing to a stipulated extension in time for consideration of its bid and its bid was guaranteed with a cashier's check, the Awarding Authority may permit the potentially successful bidder to substitute a satisfactory bid bond for the cashier's check.

PROPOSAL FORM

To: _____ Date: _____
(Awarding Authority)

In compliance with the Advertisement for Bids and subject to all the conditions thereof, the undersigned

(Legal Name of Bidder)

hereby proposes to furnish all labor and materials and perform all work required for the construction of
WORK _____

in accordance with Drawings and Specifications, dated _____, prepared by
_____, Architect/Engineer.

The Bidder, which is organized and existing under the laws of the State of _____,
having its principal offices in the City of _____,
is: a Corporation a Partnership an Individual (other) _____.

LISTING OF PARTNERS OR OFFICERS: If Bidder is a Partnership, list all partners and their addresses; if Bidder is a Corporation, list the names, titles, and business addresses of its officers:

BIDDER'S REPRESENTATION: The Bidder declares that it has examined the site of the Work, having become fully informed regarding all pertinent conditions, and that it has examined the Drawings and Specifications (including all Addenda received) for the Work and the other Bid and Contract Documents relative thereto, and that it has satisfied itself relative to the Work to be performed.

ADDENDA: The Bidder acknowledges receipt of Addenda Nos. _____ through _____ inclusively.

BASE BID: For construction complete as shown and specified, the sum of _____ Dollars (\$ _____)

ALTERNATES: If alternates as set forth in the Bid Documents are accepted, the following adjustments are to be made to the Base Bid:

- For Alternate No. 1 (.....) (add) (deduct) \$ _____
(Insert key word for Alternate)
- For Alternate No. 2 (.....) (add) (deduct) \$ _____
- For Alternate No. 3 (.....) (add) (deduct) \$ _____
- For Alternate No. 4 (.....) (add) (deduct) \$ _____
- For Alternate No. 5 (.....) (add) (deduct) \$ _____
- For Alternate No. 6 (.....) (add) (deduct) \$ _____

UNIT PRICES - (Attach to this Proposal Form the unit prices, if any, on a separate sheet.)

BID SECURITY: The undersigned agrees to enter into a Construction Contract and furnish the prescribed Performance and Payment Bonds and evidence of insurance within fifteen calendar days, or such other period stated in the Bid Documents, after the contract forms have been presented for signature, provided such presentation is made within 30 calendar days after the opening of bids, or such other period stated in the Bid Documents. As security for this condition, the undersigned further agrees that the funds represented by the Bid Bond (or cashier's check) attached hereto may be called and paid into the account of the Awarding Authority as liquidated damages for failure to so comply.

Attached hereto is a: *(Mark the appropriate box and provide the applicable information.)*

Bid Bond, executed by _____ as Surety,
 a cashier's check on the _____ Bank of _____,
for the sum of _____
Dollars (\$ _____) made payable to the Awarding Authority.

BIDDER'S ALABAMA LICENSE:

State License for General Contracting: _____
License Number Bid Limit Type(s) of Work

CERTIFICATIONS: The undersigned certifies that he or she is authorized to execute contracts on behalf of the Bidder as legally named, that this proposal is submitted in good faith without fraud or collusion with any other bidder, that the information indicated in this document is true and complete, and that the bid is made in full accord with State law. Notice of acceptance may be sent to the undersigned at the address set forth below.

The Bidder also declares that a list of all proposed major subcontractors and suppliers will be submitted at a time subsequent to the receipt of bids as established by the Architect in the Bid Documents but in no event shall this time exceed twenty-four (24) hours after receipt of bids.

Legal Name of Bidder _____

Mailing Address _____

* **By (Legal Signature)** _____

* Name & Title (print) _____ (Seal)

Telephone Number _____

Email Address _____

* If other than the individual proprietor, or an above named member of the Partnership, or the above named president, vice-president, or secretary of the Corporation, attach written authority to bind the Bidder. Any modification to a bid shall be over the initials of the person signing the bid, or of an authorized representative.

Note: A completed DCM Form C-3A: Accounting of Sales Tax must be submitted with DCM Form C-3: Proposal Form. Submission of DCM Form C-3A is required, it is not optional. A proposal shall be rendered non-responsive if an Accounting of Sales Tax is not provided.

ACCOUNTING OF SALES TAX

Attachment to DCM Form C-3: Proposal Form

To: _____ Date: _____
(Awarding Authority)

NAME OF PROJECT _____

SALES TAX ACCOUNTING

Pursuant to Act 2013-205, Section 1(g) the Contractor accounts for the sales tax NOT included in the bid proposal form as follows:

ESTIMATED SALES TAX AMOUNT

BASE BID: \$ _____

Alternate No. 1 (.....) (add) (deduct) \$ _____
(Insert key word for Alternate)

Alternate No. 2 (.....) (add) (deduct) \$ _____

Alternate No. 3 (.....) (add) (deduct) \$ _____

Alternate No. 4 (.....) (add) (deduct) \$ _____

Alternate No. 5 (.....) (add) (deduct) \$ _____

Alternate No. 6 (.....) (add) (deduct) \$ _____

Failure to provide an accounting of sales tax shall render the bid non-responsive. Other than determining responsiveness, sales tax accounting shall not affect the bid pricing nor be considered in the determination of the lowest responsible and responsive bidder.

Legal Name of Bidder _____

Mailing Address _____

***By (Legal Signature)** _____

*Name (type or print) _____ (Seal)

*Title _____

Telephone Number _____

Email Address _____

Note: A completed DCM Form C-3A: Accounting of Sales Tax must be submitted with DCM Form C-3: Proposal Form. Submission of DCM Form C-3A with DCM Form C-3 is required, it is not optional. A proposal shall be rendered non-responsive if an Accounting of Sales Tax is not provided.



ALABAMA DEPARTMENT OF REVENUE
 SALES AND USE TAX DIVISION
 P.O. Box 327710 • Montgomery, AL 36132-7710

ST: EXC-01
 8/18

Application For Sales and Use Tax Certificate of Exemption

FOR GOVERNMENT ENTITY PROJECT

This Certificate of Exemption will be limited to purchases which qualify for an exemption of sales and use taxes pursuant to Rule No. 810-6-3-.77

PROJECT INFORMATION:

PROJECT NAME		PROJECT OWNER'S FEIN (EXEMPT ENTITY)	
STREET ADDRESS OF PROJECT (CITY AND COUNTY INCLUDED)	CITY	ZIP	COUNTY

APPLICANT'S INFORMATION:

RELATION: (CHOOSE ONE)
 Government Entity General Contractor Subcontractor

APPLICANT'S LEGAL NAME	FEIN
DBA	CONSUMER'S USE TAX ACCOUNT NUMBER
MAILING ADDRESS: STREET	CITY STATE ZIP COUNTY
CONTACT PERSON	BUSINESS TELEPHONE NUMBER ()
EMAIL ADDRESS	

PROJECT START DATE (PROVIDED BY GENERAL CONTRACTOR)	PROJECT COMPLETION DATE (PROVIDED BY GENERAL CONTRACTOR)
ESTIMATED START DATE (FOR APPLICANT)	ESTIMATED COMPLETION DATE (FOR APPLICANT)
WILL THE APPLICANT HAVE ANY SUBCONTRACTORS ON THIS JOB? <input type="checkbox"/> Yes <input type="checkbox"/> No If yes, please attach list.	NAME OF PARTY TO THE CONTRACT
JOB DESCRIPTION	

WILL ANY POLLUTION CONTROL EXEMPTION BE APPLICABLE? <input type="checkbox"/> Yes <input type="checkbox"/> No	ESTIMATED POLLUTION CONTROL COST \$
---	--

TOTAL PROJECT BID AMOUNT (APPLICANT'S PORTION OF PROJECT) \$	LABOR COST (APPLICANT'S PORTION OF PROJECT) \$	MATERIAL COST (APPLICANT'S PORTION OF PROJECT) \$
--	--	---

REVENUE DEPARTMENT USE ONLY

PENDING DOCUMENTATION / INFORMATION:
 GCL SBL Contract / NTP / LOI LOS Project Dates / Breakdown of Costs

Contact Dates: _____ Received Date: _____
 _____ Forwarded for Denial: _____

PROJECT NAME

PROJECT OWNER'S FEIN (EXEMPT ENTITY)

FORM OF OWNERSHIP:

Individual Partnership Corporation Multi member LLC Single member LLC Government Entity

If applicant is a corporation, a copy of the certified certificate of incorporation, amended certificate of incorporation, certificate of authority, or articles of incorporation should be attached. If the applicant is a limited liability company or a limited liability partnership, a copy of the certified articles of organization should be attached.

OWNERSHIP INFORMATION:

Corporations – give name, title, home address, and Social Security Number of each officer.

Partnerships – give name, home address, Social Security Number or FEIN of each partner.

Sole Proprietorships – give name, home address, Social Security Number of owner.

LLC – give name, home address, and Social Security Number or FEIN of each member.

LLP – give name, home address, and Social Security Number or FEIN of each partner.

NAME (PLEASE PRINT)

SIGNATURE

TITLE

DATE

REVENUE DEPARTMENT USE ONLY

PENDING OTHER:

Government Entity General Contractor Not on LOS

Contact Dates: _____ Received Date: _____

Forwarded for Denial: _____

Examiner's Remarks _____

Examiner _____ Date _____

Instructions For Preparation of Form ST: EXC-01

Sales and Use Tax Certificate of Exemption for Government Entity Project

NOTE: Exemption Certificates will be issued as of the project start date or the received date of the application. If, upon receipt of the application, the project has already commenced, the certificate will be issued as of the received date of the application. Any purchases made prior to the issuance of a certificate will not be exempt.

***** Please allow 10 to 14 business days for your application to be processed. *****

In order to expedite the processing of your application, please include the following documentation when submitting your application:

Exempt Entity:

1. Signed Application
2. Copy of Executed/Signed Contract, Letter of Intent, Notice of Award, and/or Notice to Proceed

General Contractor:

1. Signed Application
2. Copy of Executed/Signed Contract, Letter of Intent, Notice of Award, and/or Notice to Proceed
3. List of Subcontractors
4. Alabama Board of General Contractor's License
5. State/County Business License (usually obtained through county probate office)
6. Any other municipal business licenses associated with the project

Subcontractor:

1. Signed Application
2. Alabama Board of General Contractor's License
3. State/County Business License (usually obtained through county probate office)
4. Any other municipal business licenses associated with the project
5. List of Subcontractors (if any)

General contractors and subcontractors:

- Any additions and/or deletions to the list of subcontractors working on a project must be submitted to the Department within 30 days of occurrence.
- If an extension is needed for a project, please contact the Department of Revenue at the address, number, or email listed below. Extension requests should be submitted no more than 30 days after expiration date.
- Subcontractor's Estimated Start Date should be the date they will begin working on the project and ordering materials instead of the General Contractor's Estimated Start Date for the project.

THERE IS A FILING REQUIREMENT IF YOUR APPLICATION IS APPROVED. The return will be filed through the Consumer's Use Tax account. Please see the following page for detailed instructions and general information regarding the reporting requirements.

The application and required documentation may be mailed, faxed, or emailed to the following:

Fax: (334) 353-7867

Email: STExemptionUnit@revenue.alabama.gov

Mailing Address: ATTN: Contractor's Exemption
Alabama Department of Revenue
Sales & Use Tax Division
Room 4303
PO Box 327710
Montgomery, AL 36132-7710

General Information and Instructions Regarding the Reporting Requirements for Contractors Awarded an Exemption Certificate

A contractor's exemption certificate for a Government Entity project is needed in order to purchase materials tax exempt for the qualified project. Once the exemption certificate has been applied for and awarded, there is a monthly filing requirement to report the purchases that have been made for each exempt project. The Consumer's Use (CNU) tax account is used to report the tax-exempt purchases made with each certificate for each exempt project for each month.

The consumer's use tax return must be filed for each of the months covered by the exemption certificate. (For example, if the certificate's effective date is June 29, 2014 and the expected completion date is October 1, 2014, a consumer's use tax return must be filed for each of the following months: June, July, August, September, and October.) A return MUST be filed each month to report the monthly purchases. Therefore, all active exemption certificates must be included on the monthly report even if the monthly purchases for a specific project was \$0.

If a CNU tax account is not already open under the taxpayer/business name, one will automatically be assigned at the time the exemption certificate is generated. Electronic filing is required through the Department's online filing system, My Alabama Taxes (MAT). A letter containing the online filing information will be mailed to the address on file within a few days after the new CNU tax account has been assigned. This letter will contain all the information needed to create your online filing account in MAT. For questions relating to setting up the account on www.myalabamataxes.alabama.gov, please contact Business Registration at 334-242-1584 or the Sales Tax Division at 1-866-576-6531.

Once the MAT account is set up, please log in and file the monthly CNU tax return. There is a table located at the bottom left hand corner labeled "Contractor's Exemption for Government Construction Projects." All three fields in the table are required to be completed: exemption number, project number, and total amount of purchases for that specific project for the month. Additional projects may be added on the additional rows that appear as data is added; the table will allow the addition of more projects.

***Please do not use lines 1 through 9 of the return for reporting exempt project information. Leave these lines blank unless taxable purchases were made outside of the state of Alabama that need to be reported and tax remitted. (Lines 1 through 9 do not have anything to do with the exemption reporting requirements).

When the certificate expires (upon the project's completion) and the CNU tax account is no longer needed, please contact the Business Registration Unit at 334-242-1584 and close the CNU tax account. Please be advised that if there are multiple government entity projects open, the consumer's use tax account should remain open until the last project completion date. For example, if Project EXC00ABCD ends in June of 2014 but Project EXC00EFGH ends January of 2015, the CNU tax account must remain open until the end of January 2015. A return for Project EXC00EFGH must be filed all the way through January 2015.

If the applicant already has a CNU tax account and it is currently set up online, please use this account to report exempt project purchases through www.myalabamataxes.alabama.gov using the instructions provided above. The return may then be filed as usual.

***All Consumer's Use Tax returns are due on the 20th of the month following the month in which purchases were made (i.e., the return for the month of June is due July 20th, etc. There are 20 days to file the return before it is deemed late.)

***Any penalty waiver requests may be directed to the Sales and Use Tax Division at 1-866-576-6531. Only one waiver per 18 month period is allowed.



ALABAMA DEPARTMENT OF FINANCE
 REAL PROPERTY MANAGEMENT
 Division of Construction Management

www.dcm.alabama.gov, 334-242-4082, inspections@realproperty.alabama.gov

Revised August 2020

Department Use Only
Invoice # _____
Date Paid _____
Confirmation # _____

PERMIT FEE & PERMIT RE-INSPECTION FEE CALCULATON WORKSHEET

DCM (BC) # _____	Date _____
Project Name; Owner/Architect/Engineer Project # & Phase/Package # _____	
Owner Entity Name _____	
Architect/Engineer Firm Name _____	
Contractor Company Name _____	
Awarded Contract Sum _____	
Select <u>ONE</u> of the following:	Basic Permit Fee Permit Re-Inspection Fee
Email address(es) for Payment Receipt: _____	

BASIC PERMIT FEE CALCULATION:

Awarded Contract Sum is less than \$1,000 N/A

Awarded Contract Sum is \$1,001 - \$50,000

Contract Sum less \$1,000= _____ /1,000 x \$5.00= _____ +\$15.00= _____

Awarded Contract Sum is \$50,001 - \$100,000

Contract Sum less \$50,000= _____ /1,000 x \$4.00= _____ +\$260.00= _____

Awarded Contract Sum is \$100,001 - \$500,000

Contract Sum less \$100,000= _____ /1,000 x \$3.00= _____ +\$460.00= _____

Awarded Contract Sum is \$500,001 and up

Contract Sum less \$500,000= _____ /1,000 x \$2.00= _____ +\$1,660.00= _____

PERMIT RE-INSPECTION FEE:

Flat fee of \$1,500.00 per occurrence

TOTAL DUE: _____

Basic Permit Fee: Covers all required inspections by the DCM Inspector during construction. This fee is due when a construction contract or self-performance letter is received by DCM and must be paid before the required Pre-Construction Conference is scheduled with the DCM Inspector.

Permit Re-Inspection Fee: May be charged if (A) the contractor has not completed the work required for the particular inspection as detailed in DCM Form B-8: Pre-Construction Conference Checklist, or (B) the inspection is canceled or rescheduled without the required minimum 48 hours notice to all parties.

Make check payable to: "Finance - Construction Management," include the DCM (BC) Project # on the check and attach the fee worksheet. Mail payment to: Finance - Construction Management, P.O. Box 301150, Montgomery, AL 36130-1150.

State agency inter-fund transfer and payments using Public School and College Authority (PSCA) funds: contact Jennie Jones at 334-242-4808 or jennie.jones@realproperty.alabama.gov.

Fees may be paid online at www.dcm.alabama.gov (in which case a completed fee worksheet is not required).

The Basic Permit Fee is subject to the Final Reconciliation of Fees at the close of construction.

BID BOND

The **PRINCIPAL** (*Bidder's company name and address*)

Name:
Address:

The **SURETY** (*Company name and primary place of business*)

Name:
Address:

The **OWNER** (*Entity name and address*)

Name:
Address:

The **PROJECT** for which the Principal's Bid is submitted: (*Project name as it appears in the Bid Documents*)

WILMER ELEMENTARY SCHOOL - PLAYGROUND EQUIPMENT & INSTALLATION
BSC #23-22

KNOW ALL MEN BY THESE PRESENTS, that we, the undersigned Principal and Surety, jointly and severally, hereby bind ourselves, our heirs, executors, administrators, successors, and assigns to the Owner in the **PENAL SUM of five percent (5%) of the amount of the Principal's bid, but in no event more than Ten-thousand Dollars (\$10,000.00).**

THE CONDITION OF THIS OBLIGATION is that the Principal has submitted to the Owner the attached bid, which is incorporated herein by reference, for the Project identified above.

NOW, THEREFORE, if, within the terms of the Bid Documents, the Owner accepts the Principal's bid and the Principal thereafter either:

- (a) executes and delivers a Construction Contract with the required Performance and Payment Bonds (each in the form contained in the Bid Documents and properly completed in accordance with the bid) and delivers evidence of insurance as prescribed in the Bid Documents, or
- (b) fails to execute and deliver such Construction Contract with such Bonds and evidence of insurance, but pays the Owner the difference, not to exceed the Penal Sum of this Bond, between the amount of the Principal's Bid and the larger amount for which the Owner may award a Construction Contract for the same Work to another bidder, **then**, this obligation shall be null and void, otherwise it shall remain in full force and effect.

The Surety, for value received, hereby stipulates and agrees that the obligation of the Surety under this Bond shall not in any manner be impaired or affected by any extension of the time within which the Owner may accept the Principal's bid, and the Surety does hereby waive notice of any such extension.

SIGNED AND SEALED this _____ day of _____, _____.

ATTEST:

PRINCIPAL:

By _____

Name and Title

SURETY:

By _____

Name and Title

ATTEST:

BOARD OF SCHOOL COMMISSIONERS
MOBILE COUNTY PUBLIC SCHOOLS

VENDOR MINORITY QUESTIONNAIRE

BSC NO#: 23-22

Please complete this form and return it with your bid proposal. Should you choose not to bid at this time, please complete this form and forward back to our office as soon as possible. It is necessary that you check all categories that apply to your company. Failure to comply could result in rejection of your proposal and/or removal of your name from our bidder's list, as we are now required to provide this information to the State Department.

VENDOR NAME: _____

ADDRESS: _____

PHONE #: _____

FAX #: _____

IS THE COMPANY MINORITY OWNED?: ___ YES ___ NO

IS THE COMPANY OWNED BY: ___ MALE ___ FEMALE ___ BOTH

IS THE COMPANY INCORPORATED ___ YES ___ NO

ETHNICITY OF OWNERSHIP:

___ ASIAN AMERICAN

___ AMERICAN INDIAN

___ BLACK

___ DISABLED

___ HISPANIC

___ OTHER (PLEASE SPECIFY): _____

SIGNATURE: _____

PRINT NAME: _____

TITLE: _____

DATE: _____

IMMIGRATION LAW COMPLIANCE

CONFIRMATION REQUEST: AFFIDAVIT OF ALABAMA IMMIGRATION COMPLIANCE

Vendor Information

Name: _____

Address: _____

Street Address

Suite/Unit #

City

State

ZIP Code

Phone: () _____ Alternate Phone: () _____

Please Read the attached Immigration Notice and Select one (1) of the Following:

The Alabama Immigration Law **DOES NOT** apply to the above named company. Please explain:

The Alabama Immigration Law **DOES** apply to the above named company and the documents are on file with Mobile County School System

The Alabama Immigration Law **DOES** apply to the above named company and the **AFFIDAVIT OF ALABAMA IMMIGRATION COMPLIANCE DOCUMENTS** are ATTACHED with the Bid Response

The documents are available at www.mcps.com/immigrataion and www.dhs.gov/e-verify

Employee Signature

Date

Mobile County School Board Accounts Payable Department

What is a Virtual Credit Card?

The District has adopted the use of a VISA Virtual Credit Card powered by AOC/Regions Bank. AOC receives invoice and purchase order details from Accounts Payable and assigns a one-time use credit card number.

The VISA Virtual Credit Card allows the District to pay vendors via a credit card and turn around a vendor payment in a shorter time frame than the current paper check you now receive.

How Does Virtual Credit Card Work?

- After goods are delivered and/or services rendered, vendors submit invoices to the Account Payable Department according to the current process.
- When Accounts Payable has authorization of a match (purchase order and invoice) and the invoice(s) are due for payment according to your current payment terms with the District the payment process begins.
- The vendor then receives an email notification of the payment from the District
- The vendor then logs into a secure site from the email received and puts in the assigned PIN number. Each payment notification will include the card number, expiration date, security code, payment amount and invoice and/or PO numbers.
- Once the vendor receives the email, the credit card has been authorized to be charged for the amount listed in the email. When the vendor charges the card as authorized in the email, the virtual card will no longer be available for charges. When the next payment is provided the vendor will receive a new card number, security code and expiration date with invoice amount and/or PO number.

What are the Benefits to using the VISA Virtual Card?

- Receive payments 7 -10 days sooner; resulting in a quicker cash flow for day to day operations or investments.
- Reduce the cost of paper processing and employee time spent on preparing and making bank deposits.
- Void the risk of lost or stolen checks
- Quickly reduce outstanding accounts receivable balances.

How do I Participate in the VISA Virtual Card Program?

Simply contact the Mobile County School Board Accounts Payable Department at (251)221-4437 and request to be enrolled in the VISA Virtual Card Program through AOC/Regions Bank.

AOC/Regions Bank

VISA Virtual Card Vendor Enrollment Data Elements

1. Vendor Number (Internal Use Only- MCPSS)
2. Vendor Name
3. Vendor Address
4. Accounts Receivable Contact Name
5. Accounts Receivable Contact Email
6. Accounts Receivable Contact Phone Number

Vendor please provide and complete below:

Vendor Name

Vendor Address

Vendor A/R Contact Name

Vendor A/R Email Address

Vendor A/R Phone Number

If you have any questions please contact Chuck Harben in Accounts Payable 251-221-4437 or email charben@mcpss.com.

IMPORTANT

CONTRACTORS STATEMENT

The firm of _____ will complete all items on all forms as required in the contract documents and specifications. If any form is not completely filled in as required, I could expect my bid to be rejected, and considered as an inappropriate bid this _____ day of _____, 2023

Please complete this section in it's entirety.

} Signature: _____
} Print Name: _____
} Company Name: _____
> Street Address: _____
} _____
} Phone #: (_____) _____
} FAX #: (_____) _____

ATTENTION CONTRACTORS:

In an effort to assist contractor's in complying with the requirements of the front end documents on this bid, we are providing a check list of items that must be included in your bid proposal. Failure to include any of these items may result in rejection of your bid.

I. Proposal Form Items:

- _____ Filled out properly.
- _____ Addenda acknowledged (if applicable).
- _____ Bid security information.
- _____ Base bid (written amount and number amount are the same).
- _____ Alternates add/deduct (if applicable).
- _____ Unit prices (included, if called for in specifications).
- _____ Certifications - includes:
 - _____ Legal name of bidder
 - _____ Mailing address
 - _____ Legal signature
 - _____ Typed name
 - _____ Title
- _____ If a corporation, corporate seal is affixed. If a partnership, list all partners and addresses.
- _____ General contractor's state license number.
- _____ Current construction classification.
- _____ Type of work.

II. Other forms or requirements:

- _____ Any change to the base bid such as envelope adds/deducts, adds/deducts enclosed, or correction on bid have been signed or initialed.
- _____ Bid bond, cashiers check, or certified check enclosed.
- _____ Power of Attorney enclosed.
- _____ List of subcontractors enclosed.
- _____ Covenant Against Contingent Fees enclosed.
- _____ Any other special instructions or requirements.
- _____ Contractor's Statement.
- * _____ Place General Contractor's License No. on Outside of Bid Proposal Envelope.

IMPORTANT NOTE - PLEASE READ:

Bidder **must show evidence** of License **BEFORE** bidding by clearly displaying current License No. on the **OUTSIDE** of the sealed envelope in which the Proposal is delivered, (as now required by the State of Alabama), **OR bid will not be received or considered by the Owner.** (Please see "ADVERTISEMENT FOR BIDS", Paragraph #7. in Specifications Booklet.)

COVENANT AGAINST CONTINGENT FEES

The **CONTRACTOR** warrants that no person or agency has been employed or retained to solicit or obtain this contract upon an agreement or understanding for a contingent fee, except a bona fide employee or agency. For breach or violation of this warranty, the Board of School Commissioners of Mobile County shall have the right to annul this contract without liability or, in its discretion, to deduct from the contract price or consideration, or otherwise recover, the full amount of the contingent fee.

AUTHORIZED SIGNATURE

PRINT NAME

FOR (*COMPANY NAME*)

DATE

LIST OF SUBCONTRACTORS

NOTE: All categories shall be completed designating: General Contractor, Sub-contractors; Suppliers; or N/A (not applicable).

Each bidder (General Contractor) must submit with his proposal a list of the principal subcontractors/suppliers he proposes to use, listing the name in the category of work: **See "General Conditions, Article 40", and "Supplementary General Conditions; Subcontracts, Article 40"**.

In addition to the Architect/Owners' approval, after receipt of proposal, no changes in subcontractors will be made without written approval from the Board of School Commissioners of Mobile County, Purchasing Department.

1. Site Work: _____
2. Paving: _____
3. Brick/Concrete Unit Masonry: _____
4. Structural Steel: _____
5. Roofing: _____
6. Doors and Frames: _____
7. Windows: _____
8. Finish Hardware: _____
9. Ceramic, Quarry and Resilient Floor Tile: _____
10. Acoustical Treatment: _____
11. Gym Flooring: _____
12. Carpet: _____
13. Painting: _____
14. Plumbing: _____
15. HVAC: _____
16. Electrical: _____
17. Pre-Engineered Metal Bldg. Mfg.: _____
18. Pre-Engineered Metal Bldg. Erector: _____
19. Specialties: _____
20. Equipment: _____
21. Other subcontractors/suppliers as applicable: _____



State of Alabama Disclosure Statement

Required by Article 3B of Title 41, Code of Alabama 1975

ENTITY COMPLETING FORM

ADDRESS

CITY, STATE, ZIP

TELEPHONE NUMBER

STATE AGENCY/DEPARTMENT THAT WILL RECEIVE GOODS, SERVICES, OR IS RESPONSIBLE FOR GRANT AWARD

ADDRESS

CITY, STATE, ZIP

TELEPHONE NUMBER

This form is provided with:

Contract Proposal Request for Proposal Invitation to Bid Grant Proposal

Have you or any of your partners, divisions, or any related business units previously performed work or provided goods to any State Agency/Department in the current or last fiscal year?

Yes No

If yes, identify below the State Agency/Department that received the goods or services, the type(s) of goods or services previously provided, and the amount received for the provision of such goods or services.

STATE AGENCY/DEPARTMENT	TYPE OF GOODS/SERVICES	AMOUNT RECEIVED

Have you or any of your partners, divisions, or any related business units previously applied and received any grants from any State Agency/Department in the current or last fiscal year?

Yes No

If yes, identify the State Agency/Department that awarded the grant, the date such grant was awarded, and the amount of the grant.

STATE AGENCY/DEPARTMENT	DATE GRANT AWARDED	AMOUNT OF GRANT

1. List below the name(s) and address(es) of all public officials/public employees with whom you, members of your immediate family, or any of your employees have a family relationship and who may directly personally benefit financially from the proposed transaction. Identify the State Department/Agency for which the public officials/public employees work. (Attach additional sheets if necessary.)

NAME OF PUBLIC OFFICIAL/EMPLOYEE	ADDRESS	STATE DEPARTMENT/AGENCY

2. List below the name(s) and address(es) of all family members of public officials/public employees with whom you, members of your immediate family, or any of your employees have a family relationship and who may directly personally benefit financially from the proposed transaction. Identify the public officials/public employees and State Department/Agency for which the public officials/public employees work. (Attach additional sheets if necessary.)

NAME OF FAMILY MEMBER	ADDRESS	NAME OF PUBLIC OFFICIAL/ PUBLIC EMPLOYEE	STATE DEPARTMENT/ AGENCY WHERE EMPLOYED

If you identified individuals in items one and/or two above, describe in detail below the direct financial benefit to be gained by the public officials, public employees, and/or their family members as the result of the contract, proposal, request for proposal, invitation to bid, or grant proposal. (Attach additional sheets if necessary.)

Describe in detail below any indirect financial benefits to be gained by any public official, public employee, and/or family members of the public official or public employee as the result of the contract, proposal, request for proposal, invitation to bid, or grant proposal. (Attach additional sheets if necessary.)

List below the name(s) and address(es) of all paid consultants and/or lobbyists utilized to obtain the contract, proposal, request for proposal, invitation to bid, or grant proposal:

NAME OF PAID CONSULTANT/LOBBYIST	ADDRESS

By signing below, I certify under oath and penalty of perjury that all statements on or attached to this form are true and correct to the best of my knowledge. I further understand that a civil penalty of ten percent (10%) of the amount of the transaction, not to exceed \$10,000.00, is applied for knowingly providing incorrect or misleading information.

Signature Date

Notary's Signature Date Date Notary Expires

Article 3B of Title 41, Code of Alabama 1975 requires the disclosure statement to be completed and filed with all proposals, bids, contracts, or grant proposals to the State of Alabama in excess of \$5,000.

SPECIAL NOTICE

I.
GENERAL CONDITION OF THE CONTRACT, PARAGRAPH 49, Liquidated Damages. Liquidated damages will be assessed per the scale listed below. This information will be included in the agreement between the Contractor and Owner.

<u>CONTRACT PRICE</u>					<u>PENALTY</u>	
\$	0.	-	\$ 4,999. +	=	\$ 40.00	per day
\$	5,000.	-	\$ 9,000. +	=	\$ 50.00	per day
\$	10,000.	-	\$ 19,999. +	=	\$ 80.00	per day
\$	20,000.	-	\$ 99,999. +	=	\$ 125.00	per day
\$	100,000.	-	\$ 299,999. +	=	\$ 150.00	per day
\$	300,000.	-	up	=	\$ 200.00	per day

This scale supersedes that listed in the General conditions, Paragraph 51 of the contract, revised January 1, 1983.

II.
Section 1: In the letting of public contracts in which any state, county or municipal funds are utilized, except those, contracts funded in whole or in part with funds received from a federal agency, preference shall be given to resident contractors, and a nonresident bidder domiciled in a state having laws granting preference to local contractors shall be awarded Alabama public contracts only on the same basis as the nonresident bidder's state awards contracts to Alabama contractors bidding under similar circumstances; and resident contractors in Alabama as defined in Section 39-2-12, Code of Alabama 1975, be they corporate, individuals or partnerships, are to be granted preference over nonresidents in awarded of contracts in the same manner and to the same extent as provided by the laws of the state of domicile of the nonresident.

Section 2: Nonresident bidders must accompany any written bid documents with a written opinion of an attorney at law licensed to practice law in such nonresident bidders' state of domicile, as to the preferences, if any or none, granted by the law of that state to its own business entities whose principal places of business are in that state in the letting of any or all public contracts.

*Do not staple this form and/or attachments;
use clips. Print single-sided; do not submit
double-side printed documents.*

DCM (BC) Project No.

CONSTRUCTION CONTRACT

Numbers in margin correspond to "Checklist", DCM Form B-7

- (1) This Construction Contract is entered into this _____ day of _____ in the year of 2023
- (2) between the **OWNER**, BOARD OF SCHOOL COMMISSIONERS OF MOBILE COUNTY
Entity Name: 1 MAGNUM PASS
Address: MOBILE, AL 36618
Email & Phone #: jdmorgan@mcpss.com; (251) 221-4473
- (3) and the **CONTRACTOR**,
Company Name:
Address:
Email & Phone #:
- (4) for the **WORK** of the Project, identified as:
WILMER ELEMENTARY SCHOOL - PLAYGROUND EQUIPMENT & INSTALLATION
BSC #23-22
- (5) The **CONTRACT DOCUMENTS** are dated August 23, 2023 and have been amended by
- (6) **ADDENDA**
- (7) The **ARCHITECT** is N/A
Firm Name:
Address:
Email & Phone #:
- (8) The **CONTRACT SUM** is
Dollars (\$) _____) and is the sum of the Contractor's Base Bid for the Work and the following
- (9) **BID ALTERNATE PRICES:**
- (10) The **CONTRACT TIME** is ONE HUNDRED TWENTY (120) calendar days.

THE OWNER AND THE CONTRACTOR AGREE AS FOLLOWS: The Contract Documents, as defined in the General Conditions of the Contract (DCM Form C-8), are incorporated herein by reference. The Contractor shall perform the Work in accordance with the Contract Documents. The Owner will pay and the Contractor will accept as full compensation for such performance of the Work, the Contract Sum subject to additions and deductions (including liquidated damages) as provided in the Contract Documents. The Work shall commence on a date to be specified in a Notice to Proceed issued by the Owner or the Director, Alabama Division of Construction Management, and shall then be substantially completed within the Contract Time.

- (11) **LIQUIDATED DAMAGES** for which the Contractor and its Surety (if any) shall be liable and may be required to pay the Owner in accordance with the Contract Documents shall be equal to six percent interest per annum on the total Contract Sum unless a dollar amount is stipulated in the following space, in which case liquidated damages shall be determined at _____ dollars (\$ _____) per calendar day.

Numbers in margin correspond to "Checklist", DCM Form B-7

(13) **SPECIAL PROVISIONS** *(Special Provisions may be inserted here, such as acceptance or rejection of unit prices. If Special Provisions are continued in an attachment, identify the attachment below):*

(14) **STATE GENERAL CONTRACTOR'S LICENSE:** The Contractor does hereby certify that Contractor is currently licensed by the Alabama State Licensing Board for General Contractors and that the certificate for such license bears the following:

License No.: _____ Classification(s): _____
Bid Limit: _____

The Owner and Contractor have entered into this Construction Contract as of the date first written above and have executed this Construction Contract in sufficient counterparts to enable each contracting party to have an originally executed Construction Contract each of which shall, without proof or accounting for the other counterparts, be deemed an original thereof.

The Owner does hereby certify that this Construction Contract was let in accordance with the provisions of Title 39, Code of Alabama 1975, as amended, and all other applicable provisions of law, and that the terms and commitments of this Construction Contract do not constitute a debt of the State of Alabama in violation of Article 11, Section 213 of the Constitution of Alabama, 1901, as amended by Amendment Number 26.

(15)

APPROVAL

**ALABAMA STATE DEPARTMENT OF EDUCATION
(SDE)**
(Required for locally-funded, SDE projects)

By _____ Date _____
State Superintendent of Education

CONTRACTING PARTIES

Contractor Company

By _____
Signature

Name & Title _____

BOARD OF SCH COMMISSIONERS OF MOBILE CO
Owner Entity

By _____
Signature

Name(s) & Title(s) Chresal D. Threadgill, Superintendent

Review/Signature flow: Architect/Engineer (prepare documents) > Contractor (review and sign) > Architect/Engineer (review) > Owner (review and sign) > SDE (review, sign and distribute the fully executed Contract to all parties, and forward a copy to the Alabama Division of Construction Management [DCM]). Note: DCM does not sign fully locally-funded SDE project contract documents.

Numbers in margin correspond to second page of "Checklist", DCM Form B-7

(1) **PERFORMANCE BOND**

SURETY'S BOND NUMBER

Do not staple this form; use clips.

(2) **The PRINCIPAL** (*Company name and address of Contractor as appears in the Construction Contract*)

Name:
Address:

(3) **The SURETY** (*Company name and primary place of business*)

Name:
Address:

(4) **The OWNER** (*Entity name and address, same as appears in the Construction Contract*)

Name:
Address:

(5) **The PENAL SUM** of this Bond (the Contract Sum)

Dollars (\$) _____).

(6) **DATE** of the Construction Contract :

(7) **The PROJECT:** (*Same as appears in the Construction Contract*)

WILMER ELEMENTARY SCHOOL
PLAYGROUND EQUIPMENT & INSTALLATION
BSC #23-22

1. WE, THE PRINCIPAL (hereinafter "Contractor") AND THE SURETY, jointly and severally, hereby bind ourselves, our heirs, executors, administrators, successors, and assigns to the Owner in the Penal Sum stated above for the performance of the Contract, and Contract Change Orders, in accord with the requirements of the Contract Documents, which are incorporated herein by reference. If the Contractor performs the Contract, and Contract Change Orders, in accordance with the Contract Documents, then this obligation shall be null and void; otherwise it shall remain in full force and effect.

2. The Penal Sum shall remain equal to the Contract Sum as the Contract Sum is adjusted by Contract Change Orders. All Contract Change Orders involving an increase in the Contract Sum will require consent of Surety by endorsement of the Contract Change Order form. The Surety waives notification of any Contract Change Orders involving only extension of the Contract Time.

Numbers in margin correspond to second page of "Checklist": DCM Form B-7

3. Whenever the Architect gives the Contractor and the Surety, at their addresses stated above, a written Notice to Cure a condition for which the Contract may be terminated in accordance with the Contract Documents, the Surety may, within the time stated in the notice, cure or provide the Architect with written verification that satisfactory positive action is in process to cure the condition.
4. The Surety's obligation under this Bond becomes effective after the Contractor fails to satisfy a Notice to Cure and the Owner:
 - (a) gives the Contractor and the Surety, at their addresses stated above, a written Notice of Termination declaring the Contractor to be in default under the Contract and stating that the Contractor's right to complete the Work, or a designated portion of the Work, shall terminate seven days after the Contractor's receipt of the notice; and
 - (b) gives the Surety a written demand that, upon the effective date of the Notice of Termination, the Surety promptly fulfill its obligation under this Bond.
5. In the presence of the conditions described in Paragraph 4, the Surety shall, at its expense:
 - (a) On the effective date of the Notice of Termination, take charge of the Work and be responsible for the safety, security, and protection of the Work, including materials and equipment stored on and off the Project site, and
 - (b) Within twenty-one days after the effective date of the Notice of Termination, proceed, or provide the Owner with written verification that satisfactory positive action is in process to facilitate proceeding promptly, to complete the Work in accordance with the Contract Documents, either with the Surety's resources or through a contract between the Surety and a qualified contractor to whom the Owner has no reasonable objection.
6. As conditions precedent to taking charge of and completing the Work pursuant to Paragraph 5, the Surety shall neither require, nor be entitled to, any agreements or conditions other than those of this Bond and the Contract Documents. In taking charge of and completing the Work, the Surety shall assume all rights and obligations of the Contractor under the Contract Documents; however, the Surety shall also have the right to assert "Surety Claims" to the Owner in accordance with the Contract Documents. The presence or possibility of a Surety Claim shall not be just cause for the Surety to fail or refuse to promptly take charge of and complete the Work or for the Owner to fail or refuse to continue to make payments in accordance with the Contract Documents.
7. By accepting this Bond as a condition of executing the Construction Contract, and by taking the actions described in Paragraph 4, the Owner agrees that:
 - (a) the Owner shall promptly advise the Surety of the unpaid balance of the Contract Sum and, upon request, shall make available or furnish to the Surety, at the cost of reproduction, any portions of the Project Record, and
 - (b) as the Surety completes the Work, or has it completed by a qualified contractor, the Owner shall pay the Surety, in accordance with terms of payment of the Contract Documents, the unpaid balance of the Contract Sum, less any amounts that may be or become due the Owner from the Contractor under the Construction Contract or from the Contractor or the Surety under this Bond.
8. In the presence of the conditions described in Paragraph 4, the Surety's obligation includes responsibility for the correction of Defective Work, liquidated damages, and reimbursement of any reasonable expenses incurred by the Owner as a result of the Contractor's default under the Contract, including architectural, engineering, administrative, and legal services.

Numbers in margin correspond to second page of "Checklist", DCM Form B-7

9. Nothing contained in this Bond shall be construed to mean that the Surety shall be liable to the Owner for an amount exceeding the Penal Sum of this Bond, except in the event that the Surety should be in default under the Bond by failing or refusing to take charge of and complete the Work pursuant to Paragraph 5. If the Surety should fail or refuse to take charge of and complete the Work, the Owner shall have the authority to take charge of and complete the Work, or have it completed, and the following costs to the Owner, less the unpaid balance of the Contract Sum, shall be recoverable under this Bond:

- (a) the cost of completing the Contractor's responsibilities under the Contract, including correction of Defective Work;
- (b) additional architectural, engineering, managerial, and administrative services, and reasonable attorneys' fees incident to completing the Work;
- (c) interest on, and the cost of obtaining, funds to supplement the unpaid balance of the Contract Sum as may be necessary to cover the foregoing costs;
- (d) the fair market value of any reductions in the scope of the Work necessitated by insufficiency of the unpaid balance of the Contract Sum and available supplemental funds to cover the foregoing costs; and
- (f) additional architectural, engineering, managerial, and administrative services, and reasonable attorneys' fees incident to ascertaining and collecting the Owner's losses under the Bond.

10. All claims and disputes arising out of or related to this bond, or its breach, shall be resolved in accordance with Article 24, General Conditions of the Contract.

(8) **SIGNED AND SEALED** this _____ day of _____, _____.

(9 & 10)

SURETY:

CONTRACTOR as PRINCIPAL:

Company Name

By _____
Signature

Name and Title

Company Name

By _____
Signature

Name and Title

(11) NOTE: Original power of attorney for the Surety's signatory shall be furnished with each of the original six bond forms to be attached to each of the six contract forms per project.

Do not staple this form; use clips. Purpose: quickly and efficiently scan thousands of documents into DCM's database.

Numbers in margin correspond to second page of "Checklist", DCM Form B-7

(1) **PAYMENT BOND**

SURETY'S BOND NUMBER

Do not staple this form; use clips.

(2) The **PRINCIPAL** (*Company name and address of Contractor, same as appears in the Construction Contract*)

Name:
Address:

(3) The **SURETY** (*Company name and primary place of business*)

Name:
Address:

(4) The **OWNER(s)** (*Entity name and address, same as appears in the Construction Contract*)

Name:
Address:

(5) The **PENAL SUM** of this Bond (the Contract Sum)

Dollars (\$) _____).

(6) **DATE** of the Construction Contract:

(7) The **PROJECT**: (*Same as appears in the Construction Contract*)

WILMER ELEMENTARY SCHOOL
PLAYGROUND EQUIPMENT & INSTALLATION
BSC #23-22

1. **WE, THE PRINCIPAL (hereinafter "Contractor") AND THE SURETY**, jointly and severally, hereby bind ourselves, our heirs, executors, administrators, successors, and assigns to the Owner in the Penal Sum stated above to promptly pay all persons supplying labor, materials, or supplies for or in the prosecution of the Contract, which is incorporated herein by reference, and any modifications thereof by Contract Change Orders. If the Contractor and its Subcontractors promptly pay all persons supplying labor, materials, or supplies for or in the prosecution of the Contract and Contract Change Orders, then this obligation shall be null and void; otherwise to remain and be in full force and effect.
2. The Penal Sum shall remain equal to the Contract Sum as the Contract Sum is adjusted by Contract Change Orders. All Contract Change Orders involving an increase in the Contract Sum will require consent of Surety by endorsement of the Contract Change Order form. The Surety waives notification of any Contract Change Orders involving only extension of the Contract Time.

Numbers in margin correspond to second page of "Checklist", DCM Form B-7

- 3. Any person that has furnished labor, materials, or supplies for or in the prosecution of the Contract and Contract Change Orders for which payment has not been timely made may institute a civil action upon this Bond and have their rights and claims adjudicated in a civil action and judgment entered thereon. Notwithstanding the foregoing, a civil action may not be instituted on this bond until 45 days after written notice to the Surety of the amount claimed to be due and the nature of the claim. The civil action must commence not later than one year from the date of final settlement of the Contract. The giving of notice by registered or certified mail, postage prepaid, addressed to the Surety at any of its places of business or offices shall be deemed sufficient. In the event the Surety or Contractor fails to pay the claim in full within 45 days from the mailing of the notice, then the person or persons may recover from the Contractor and Surety, in addition to the amount of the claim, a reasonable attorney's fee based on the result, together with interest on the claim from the date of the notice.
- 4. Every person having a right of action on this bond shall, upon written application to the Owner indicating that labor, material, or supplies for the Work have been supplied and that payment has not been made, be promptly furnished a certified copy of this bond and the Construction Contract. The claimant may bring a civil action in the claimant's name on this Bond against the Contractor and the Surety, or either of them, in the county in which the Work is to be or has been performed or in any other county where venue is otherwise allowed by law.
- 5. This bond is furnished to comply with Code of Alabama, §39-1-1, and all provisions thereof shall be applicable to civil actions upon this bond.
- 6. All claims and disputes between Owner and either the Contractor or Surety arising out of or related to this bond, or its breach, shall be resolved in accordance with Article 24, General Conditions of the Contract.

(8) **SIGNED AND SEALED** this _____ day of _____, _____.

(9 & 10) **SURETY:**

CONTRACTOR as PRINCIPAL:

Company Name

By _____
Signature

Name and Title

Company Name

By _____
Signature

Name and Title

(11) **NOTE:** Original power of attorney for the Surety's signatory shall be furnished with each of the original six bond forms to be attached to each of the six contract forms per project.

Do not staple this form; use clips. Purpose: quickly and efficiently scan thousands of documents into DCM's database.

GENERAL CONDITIONS of the CONTRACT

CONTENTS

1. Definitions
2. Intent and Interpretation of the Contract Documents
3. Contractor's Representation
4. Documents Furnished to Contractor
5. Ownership of Drawings
6. Supervision, Superintendent, & Employees
7. Review of Contract Documents and Field Conditions by Contractor
8. Surveys by Contractor
9. Submittals
10. Documents and Samples at the Site
11. "As-built" Documents
12. Progress Schedule
13. Materials, Equipment & Substitutions
14. Safety & Protection of Persons & Property
15. Hazardous Materials
16. Inspection of the Work
17. Correction of Work
18. Deductions for Uncorrected Work
19. Changes in the Work
20. Claims for Extra Cost or Extra Work
21. Differing Site Conditions
22. Claims for Damages
23. Delays
24. Resolution of Claims and Disputes
25. Owner's Right to Correct Work
26. Owner's Right to Stop or Suspend the Work
27. Owner's Right to Terminate Contract
28. Contractor's Right to Suspend or Terminate
29. Progress Payments
30. Certification & Approvals for Payments
31. Payments Withheld
32. Substantial Completion
33. Occupancy or Use Prior to Completion
34. Final Payment
35. Contractor's Warranty
36. Indemnification Agreement
37. Insurance
38. Performance and Payment Bonds
39. Assignment
40. Construction by Owner or Separate Contracts
41. Subcontracts
42. Architect's Status
43. Cash Allowances
44. Permits, Laws and Regulations
45. Royalties, Patents and Copyrights
46. Use of the Site
47. Cutting and Patching
48. In-progress and Final Cleanup
49. Liquidated Damages
50. Use of Foreign Material
51. Sign

ARTICLE 1 DEFINITIONS

Whenever the following terms, or pronouns in place of them, are used in the Contract Documents, the intent and meaning shall be interpreted as follows:

- A. **ALABAMA DIVISION OF CONSTRUCTION MANAGEMENT:** The Technical Staff of the Alabama Division of Construction Management.
- B. **ARCHITECT:** The Architect is the person or entity lawfully licensed to practice architecture in the State of Alabama, who is under contract with the Owner as the primary design professional for the Project and identified as the Architect in the Construction Contract. The term "Architect" means the Architect or the Architect's authorized representative. If the employment of the Architect is terminated, the Owner shall employ a new Architect whose status under the Contract Documents shall be that of the former Architect. If the primary design professional for the Project is a Professional Engineer, the term "Engineer" shall be substituted for the term "Architect" wherever it appears in this document.

- C. COMMISSION:** The former Alabama Building Commission, for which the Alabama Division of Construction Management has been designated by the Legislature as its successor.
- D. CONTRACT:** The Contract is the embodiment of the Contract Documents. The Contract represents the entire and integrated agreement between the Owner and Contractor and supersedes any prior written or oral negotiations, representations or agreements that are not incorporated into the Contract Documents. The Contract may be amended only by a Contract Change Order or a Modification to the Construction Contract. The contractual relationship which the Contract creates between the Owner and the Contractor extends to no other persons or entities. The Contract consists of the following Contract Documents, including all additions, deletions, and modifications incorporated therein before the execution of the Construction Contract:
- (1) Construction Contract
 - (2) Performance and Payment Bonds
 - (3) Conditions of the Contract (General, Supplemental, and other Conditions)
 - (4) Specifications
 - (5) Drawings
 - (6) Contract Change Orders
 - (7) Modifications to the Construction Contract (applicable to PSCA Projects)
- E. CONTRACT SUM:** The Contract Sum is the total amount payable by the Owner to the Contractor for performance of the Work under the Contract Documents. The term "Contract Sum" means the Contract Sum stated in the Construction Contract as may have been increased or decreased by Change Order(s) in accordance with the Contract Documents.
- F. CONTRACT TIME:** The Contract Time is the period of time in which the Contractor must achieve Substantial Completion of the Work. The date on which the Contract Time begins is specified in the written Notice To Proceed issued to the Contractor by the Owner or Director. The Date of Substantial Completion is the date established in accordance with Article 32. The term "Contract Time" means the Contract Time stated in the Construction Contract as may have been extended by Change Order(s) in accordance with the Contract Documents. The term "day" as used in the Contract Documents shall mean calendar day unless otherwise specifically defined.
- G. CONTRACTOR:** The Contractor is the person or persons, firm, partnership, joint venture, association, corporation, cooperative, limited liability company, or other legal entity, identified as such in the Construction Contract. The term "Contractor" means the Contractor or the Contractor's authorized representative.
- H. DCM:** The Alabama Division of Construction Management.
- I. DCM PROJECT INSPECTOR:** The member of the Technical Staff of the Alabama Division of Construction Management to whom the Project is assigned relative to executing the respective inspections and authorities described in Article 16, Inspection of the Work.
- J. DEFECTIVE WORK:** The term "Defective Work" shall apply to: (1) any product, material, system, equipment, or service, or its installation or performance, which does not conform to the requirements of the Contract Documents, (2) in-progress or completed Work the workmanship of which does not conform to the quality specified or, if not specified, to the quality produced by skilled workers performing work of a similar nature on similar projects in the state, (3) substitutions and deviations not properly submitted and approved or otherwise authorized, (4) temporary

supports, structures, or construction which will not produce the results required by the Contract Documents, and (5) materials or equipment rendered unsuitable for incorporation into the Work due to improper storage or protection.

- K. DIRECTOR:** The Director of the Alabama Division of Construction Management.
- L. DRAWINGS:** The Drawings are the portions of the Contract Documents showing graphically the design, location, layout, and dimensions of the Work, in the form of plans, elevations, sections, details, schedules, and diagrams.
- M. NOTICE TO PROCEED:** A proceed order issued by the Owner or Director, as applicable, fixing the date on which the Contractor shall begin the prosecution of the Work, which is also the date on which the Contract Time shall begin.
- N. OWNER:** The Owner is the entity or entities identified as such in the Construction Contract and is referred to throughout the Contract Documents as if singular in number. The term "Owner" means the Owner or the Owner's authorized representative. The term "Owner" as used herein shall be synonymous with the term "Awarding Authority" as defined and used in Title 39 - Public Works, Code of Alabama, 1975, as amended.
- O. THE PROJECT:** The Project is the total construction of which the Work required by these Contract Documents may be the entirety or only a part with other portions to be constructed by the Owner or separate contractors.
- P. PROJECT MANUAL:** The Project Manual is the volume usually assembled for the Work which may include the Advertisement for Bids, Instructions to Bidders, sample forms, General Conditions of the Contract, Supplementary Conditions, and Specifications of the Work.
- Q. SPECIFICATIONS:** The Specifications are that portion of the Contract Documents which set forth in writing the standards of quality and performance of products, equipment, materials, systems, and services and workmanship required for acceptable performance of the Work.
- R. SUBCONTRACTOR:** A Subcontractor is a person or entity who is undertaking the performance of any part of the Work by virtue of a contract with the Contractor. The term "Subcontractor" means a Subcontractor or its authorized representatives.
- S. THE WORK:** The Work is the construction and services required by the Contract Documents and includes all labor, materials, supplies, equipment, and other items and services as are necessary to produce the required construction and to fulfill the Contractor's obligations under the Contract. The Work may constitute the entire Project or only a portion of it.

ARTICLE 2

INTENT and INTERPRETATION of the CONTRACT DOCUMENTS

A. INTENT

It is the intent of the Contract Documents that the Contractor shall properly execute and complete the Work described by the Contract Documents, and unless otherwise provided in the Contract, the

Contractor shall provide all labor, materials, equipment, tools, construction equipment and machinery, water, heat, utilities, transportation, and other facilities and services, whether temporary or permanent and whether or not incorporated or to be incorporated in the Work, in full accordance with the Contract Documents and reasonably inferable from them as being necessary to produce the indicated results.

B. COMPLEMENTARY DOCUMENTS

The Contract Documents are complementary. If Work is required by one Contract Document, the Contractor shall perform the Work as if it were required by all of the Contract Documents. However, the Contractor shall be required to perform Work only to the extent that is consistent with the Contract Documents and reasonably inferable from them as being necessary to produce the indicated results.

C. ORDER of PRECEDENCE

Should any discrepancy arise between the various elements of the Contract Documents, precedence shall be given to them in the following order unless to do so would contravene the apparent Intent of the Contract Documents stated in preceding Paragraph A:

- (1) The Construction Contract.
- (2) Addenda, with those of later date having precedence over those of earlier date.
- (3) Supplementary Conditions (or other Conditions which modify the General Conditions of the Contract).
- (4) General Conditions of the Contract.
- (5) The Specifications.
- (6) Details appearing on the Drawings; large scale details shall take precedence over smaller scale details.
- (7) The Drawings; large scale drawings shall take precedence over smaller scale drawings.

D. ORGANIZATION

Except as may be specifically stated within the technical specifications, neither the organization of the Specifications into divisions, sections, or otherwise, nor any arrangement of the Drawings shall control how the Contractor subcontracts portions of the Work or assigns Work to any trade.

E. INTERPRETATION

(1) The Contract Documents shall be interpreted collectively, each part complementing the others and consistent with the Intent of the Contract Documents stated in preceding Paragraph A. Unless an item shown or described in the Contract Documents is specifically identified to be furnished or installed by the Owner or others or is identified as "Not In Contract" ("N.I.C."), the Contractor's obligation relative to that item shall be interpreted to include furnishing, assembling, installing, finishing, and/or connecting the item at the Contractor's expense to produce a product or system that is complete, appropriately tested, and in operative condition ready for use or subsequent construction or operation of the Owner or separate contractors. The omission of words or phrases for brevity of the Contract Documents, the inadvertent omission of words or phrases, or obvious typographical or written errors shall not defeat such interpretation as long as it is reasonably inferable from the Contract Documents as a whole.

(2) Words or phrases used in the Contract Documents which have well-known technical or

construction industry meanings are to be interpreted consistent with such recognized meanings unless otherwise indicated.

(3) Except as noted otherwise, references to standard specifications or publications of associations, bureaus, or organizations shall mean the latest edition of the referenced standard specification or publication as of the date of the Advertisement for Bids.

(4) In the case of inconsistency between Drawings and Specifications or within either document not clarified by addendum, the better quality or greater quantity of Work shall be provided in accordance with the Architect's interpretation.

(5) Any portions of the Contract Documents written in longhand must be initialed by all parties..

(6) Any doubt as to the meaning of the Contract Documents or any obscurity as to the wording of them, shall be promptly submitted in writing to the Architect for written interpretation, explanation, or clarification.

F. SEVERABILITY.

The partial or complete invalidity of any one or more provision of this Contract shall not affect the validity or continuing force and effect of any other provision.

ARTICLE 3
CONTRACTOR'S REPRESENTATIONS

By executing the Construction Contract the Contractor represents to the Owner:

- A. The Contractor has visited the site of the Work to become familiar with local conditions under which the Work is to be performed and to evaluate reasonably observable conditions as compared with requirements of the Contract Documents.
- B. The Contractor shall use its best skill and attention to perform the Work in an expeditious manner consistent with the Contract Documents.
- C. The Contractor is an independent contractor and in performance of the Contract remains and shall act as an independent contractor having no authority to represent or obligate the Owner in any manner unless authorized by the Owner in writing.

ARTICLE 4
DOCUMENTS FURNISHED to CONTRACTOR

Unless otherwise provided in the Contract Documents, twenty sets of Drawings and Project Manuals will be furnished to the Contractor by the Architect without charge. Other copies requested will be furnished at reproduction cost.

ARTICLE 5
OWNERSHIP of DRAWINGS

All original or duplicated Drawings, Specifications, and other documents prepared by the Architect, and furnished to the Contractor are the property of the Architect and are to be used solely for this Project and not to be used in any manner for other work. Upon completion of the Work, all copies of Drawings and Specifications, with the exception of the Contractor's record set, shall be returned or accounted for by the Contractor to the Architect, on request.

ARTICLE 6
SUPERVISION, SUPERINTENDENT, and EMPLOYEES

A. SUPERVISION and CONSTRUCTION METHODS

- (1) The term "Construction Methods" means the construction means, methods, techniques, sequences, and procedures utilized by the Contractor in performing the Work. The Contractor is solely responsible for supervising and coordinating the performance of the Work, including the selection of Construction Methods, unless the Contract Documents give other specific instructions concerning these matters.
- (2) The Contractor is solely and completely responsible for job site safety, including the protection of persons and property in accordance with Article 14.
- (3) The Contractor shall be responsible to the Owner for acts and omissions of not only the Contractor and its agents and employees, but all persons and entities, and their agents and employees, who are performing portions of the Work for or on behalf of the Contractor or any of its Subcontractors.
- (4) The Contractor shall be responsible to inspect the in-progress and completed Work to verify its compliance with the Contract Documents and to insure that any element or portion of the Work upon which subsequent Work is to be applied or performed is in proper condition to receive the subsequent Work.

B. SUPERINTENDENT

- (1) The Contractor shall employ and maintain a competent level of supervision for the performance of the Work at the Project site, including a superintendent who shall:
 - (a) have full authority to receive instructions from the Architect or Owner and to act on those instructions and
 - (b) be present at the Project site at all times during which Work is being performed.
- (2) Before beginning performance of the Work, the Contractor shall notify the Architect in writing of the name and qualifications of its proposed superintendent so that the Owner may review the individual's qualifications. If, for reasonable cause, the Owner refuses to approve the individual, or withdraws its approval after once giving it, the Contractor shall name a different superintendent for the Owner's review and approval. Any disapproved superintendent will not perform in that capacity thereafter at the Project site.

C. EMPLOYEES

The Contractor shall permit only fit and skilled persons to perform the Work. The Contractor shall enforce safety procedures, strict discipline, and good order among persons performing the Work. The Contractor will remove from its employment on the Project any person who deliberately or persistently produces non-conforming Work or who fails or refuses to conform to reasonable rules of personal conduct contained in the Contract Documents or implemented by the Owner and delivered to the Contractor in writing during the course of the Work.

ARTICLE 7

REVIEW of CONTRACT DOCUMENTS and FIELD CONDITIONS by CONTRACTOR

- A.** In order to facilitate assembly and installation of the Work in accordance with the Contract Documents, before starting each portion of the Work, the Contractor shall examine and compare the relevant Contract Documents, and compare them to relevant field measurements made by the Contractor and any conditions at the site affecting that portion of the Work.
- B.** If the Contractor discovers any errors, omissions, or inconsistencies in the Contract Documents, the Contractor shall promptly report them to the Architect as a written request for information that includes a detailed statement identifying the specific Drawings or Specifications that are in need of clarification and the error, omission, or inconsistency discovered in them.
- (1)** The Contractor shall not be expected to act as a licensed design professional and ascertain whether the Contract Documents comply with applicable laws, statutes, ordinances, building codes, and rules and regulations, but the Contractor shall be obligated to promptly notify the Architect of any such noncompliance discovered by or made known to the Contractor. If the Contractor performs Work without fulfilling this notification obligation, the Contractor shall pay the resulting costs and damages that would have been avoided by such notification.
- (2)** The Contractor shall not be liable to the Owner for errors, omissions, or inconsistencies that may exist in the Contract Documents, or between the Contract Documents and conditions at the site, unless the Contractor knowingly fails to report a discovered error, omission, or inconsistency to the Architect, in which case the Contractor shall pay the resulting costs and damages that would have been avoided by such notification.
- C.** If the Contractor considers the Architect's response to a request for information to constitute a change to the Contract Documents involving additional costs and/or time, the Contractor shall follow the procedures of Article 20, Claims for Extra Cost or Extra Work.
- D.** If, with undue frequency, the Contractor requests information that is obtainable through reasonable examination and comparison of the Contract Documents, site conditions, and previous correspondence, interpretations, or clarifications, the Contractor shall be liable to the Owner for reasonable charges from the Architect for the additional services required to review, research, and respond to such requests for information.

ARTICLE 8
SURVEYS by CONTRACTOR

- A.** The Contractor shall provide competent engineering services to assure accurate execution of the Work in accordance with the Contract Documents. The Contractor shall verify the figures given for the contours, approaches and locations shown on the Drawings before starting any Work and be responsible for the accuracy of the finished Work. Without extra cost to the Owner, the Contractor shall engage a licensed surveyor if necessary to verify boundary lines, keep within property lines, and shall be responsible for encroachments on rights or property of public or surrounding property owners.
- B.** The Contractor shall establish all base lines for the location of the principal components of the Work and make all detail surveys necessary for construction, including grade stakes, batter boards and other working points, lines and elevations. If the Work involves alteration of or addition to existing structures or improvements, the Contractor shall locate and measure elements of the existing conditions as is necessary to facilitate accurate fabrication, assembly, and installation of new Work in the relationship, alignment, and/or connection to the existing structure or improvement as is shown in the Contract Documents.

ARTICLE 9
SUBMITTALS

- A.** Where required by the Contract Documents, the Contractor shall submit shop drawings, product data, samples and other information (hereinafter referred to as Submittals) to the Architect for the purpose of demonstrating the way by which the Contractor proposes to conform to the requirements of the Contract Documents. Submittals which are not required by the Contract Documents may be returned by the Architect without action.
- B.** The Contractor shall be responsible to the Owner for the accuracy of its Submittals and the conformity of its submitted information to the requirements of the Contract Documents. Each Submittal shall bear the Contractor's approval, evidencing that the Contractor has reviewed and found the information to be in compliance with the requirements of the Contract Documents. Submittals which are not marked as reviewed and approved by the Contractor may be returned by the Architect without action.
- C.** The Contractor shall prepare and deliver its submittals to the Architect sufficiently in advance of construction requirements and in a sequence as to cause no delay in the Work or in the activities of the Owner or of separate contractors. In coordinating the Submittal process with its construction schedule, the Contractor shall allow sufficient time to permit adequate review by the Architect.
- D.** By approving a Submittal the Contractor represents not only that the element of Work presented in the Submittal complies with the requirements of the Contract Documents, but also that the Contractor has:
 - (1)** found the layout and/or dimensions in the Submittal to be comparable with those in the Contract Documents and other relevant Submittals and has made field measurements as necessary to verify their accuracy, and
 - (2)** determined that products, materials, systems, equipment and/or procedures presented in the Submittal are compatible with those presented, or being presented, in other relevant Submittals and

with the Contractor's intended Construction Methods.

- E. The Contractor shall not fabricate or perform any portion of the Work for which the Contract Documents require Submittals until the respective Submittals have been approved by the Architect.
- F. In the case of a resubmission, the Contractor shall direct specific attention to all revisions in a Submittal. The Architect's approval of a resubmission shall not apply to any revisions that were not brought to the Architect's attention.
- G. If the Contract Documents specify that a Submittal is to be prepared and sealed by a registered architect or licensed engineer retained by the Contractor, all drawings, calculations, specifications, and certifications of the Submittal shall bear the Alabama seal of registration and signature of the registered/licensed design professional who prepared them or under whose supervision they were prepared. The Owner and the Architect shall be entitled to rely upon the adequacy, accuracy and completeness of such a Submittal, provided that all performance and design criteria that such Submittal must satisfy are sufficiently specified in the Contract Documents. The Architect will review, approve or take other appropriate action on such a Submittal only for the limited purpose of checking for conformance with information given and the design concept expressed in the Contract Documents. The Contractor shall not be responsible for the adequacy of the performance or design criteria specified in the Contract Documents.

H. DEVIATIONS

(1) The Architect is authorized by the Owner to approve "minor" deviations from the requirements of the Contract Documents. "Minor" deviations are defined as those which are in the interest of the Owner, do not materially alter the quality or performance of the finished Work, and do not affect the cost or time of performance of the Work. Deviations which are not "minor" may be authorized only by the Owner through the Change Order procedures of Article 19.

(2) Any deviation from the requirements of the Contract Documents contained in a Submittal shall be clearly identified as a "Deviation from Contract Requirements" (or by similar language) within the Submittal and, in a letter transmitting the Submittal to the Architect, the Contractor shall direct the Architect's attention to, and request specific approval of, the deviation. Otherwise, the Architect's approval of a Submittal does not constitute approval of deviations from the requirements of the Contract Documents contained in the Submittal.

(3) The Contractor shall bear all costs and expenses of any changes to the Work, changes to work performed by the Owner or separate contractors, or additional services by the Architect required to accommodate an approved deviation unless the Contractor has specifically informed the Architect in writing of the required changes and a Change Order has been issued authorizing the deviation and accounting for such resulting changes and costs.

I. ARCHITECT'S REVIEW and APPROVAL

(1) The Architect will review the Contractor's Submittals for conformance with requirements of, and the design concept expressed in, the Contract Documents and will approve or take other appropriate action upon them. This review is not intended to verify the accuracy and completeness of details such as dimensions and quantities nor to substantiate installation instructions or performance of equipment or systems, all of which remain the responsibility of the Contractor. However, the Architect shall advise the Contractor of any errors or omissions which the Architect

may detect during this review. The Architect's approval of a specific item shall not indicate approval of an assembly of which the item is a component.

(2) The Architect will review and respond to all Submittals with reasonable promptness to avoid delay in the Work or in the activities of the Owner, Contractor or separate contractors, while allowing sufficient time to permit adequate review.

(3) No corrections or changes to Submittals indicated by the Architect will be considered as authorizations to perform Extra Work. If the Contractor considers such correction or change of a Submittal to require Work which differs from the requirements of the Contract Documents, the Contractor shall promptly notify the Architect in writing in accordance with Article 20, Claims for Extra Cost or Extra Work.

J. CONFORMANCE with SUBMITTALS

The Work shall be constructed in accordance with approved Submittals.

**ARTICLE 10
DOCUMENTS and SAMPLES at the SITE**

A. "AS ISSUED" SET

The Contractor shall maintain at the Project site, in good order, at least one copy of all Addenda, Change Orders, supplemental drawings, written directives and clarifications, and approved Submittals intact as issued, and an updated construction schedule.

B. "POSTED" SET

The Contractor shall maintain at the Project site, in good order, at least one set of the Drawings and Project Manual into which the Contractor has "posted"(incorporated) all Addenda, Change Orders, supplemental drawings, clarifications, and other information pertinent to the proper performance of the Work. The Contractor shall assure that all sets of the Drawings and Project Manuals being used by the Contractor, Subcontractors, and suppliers are "posted" with the current information to insure that updated Contract Documents are used for performance of the Work.

C. RECORD SET

One set of the Drawings and Project Manual described in Paragraph B shall be the Contractor's record set in which the Contractor shall record all field changes, corrections, selections, final locations, and other information as will be duplicated on the "As-built" documents required under Article 11. The Contractor shall record such "as-built" information in its record set as it becomes available through progress of the Work. The Contractor's performance of this requirement shall be subject to confirmation by the Architect at any time as a prerequisite to approval of Progress Payments.

D. The documents and samples required by this Article to be maintained at the Project site shall be readily available to the Architect, Owner, DCM Project Inspector, and their representatives.

ARTICLE 11
“AS-BUILT” DOCUMENTS

- A. Unless otherwise provided in the Contract Documents, the Contractor shall deliver two (2) sets of “As-built” documents, as described herein, to the Architect for submission to the Owner upon completion of the Work. Each set of “As-built” documents shall consist of a copy of the Drawings and Project Manual, in like-new condition, into which the Contractor has neatly incorporated all Addenda, Change Orders, supplemental drawings, clarifications, field changes, corrections, selections, actual locations of underground utilities, and other information as required herein or specified elsewhere in the Contract Documents.
- B. The Contractor shall use the following methods for incorporating information into the “As-built” documents:
- (1) **Drawings**
- (a) To the greatest extent practicable, information shall be carefully drawn and lettered, in ink, on the Drawings in the form of sketches, details, plans, notes, and dimensions as required to provide a fully dimensioned record of the Work. When required for clarity, sketches, details, or partial plans shall be drawn on supplemental sheets and bound into the Drawings and referenced on the drawing being revised.
- (b) Where a revised drawing has been furnished by the Architect, the drawing of latest date shall be bound into the Drawings in the place of the superseded drawing.
- (c) Where a supplemental drawing has been furnished by the Architect, the supplemental drawing shall be bound into the Drawings in an appropriate location and referred to by notes added to the drawing being supplemented.
- (d) Where the Architect has furnished details, partial plans, or lengthy notes of which it would be impractical for the Contractor to redraw or letter on a drawing, such information may be affixed to the appropriate drawing with transparent tape if space is available on the drawing.
- (e) Any entry of information made in the Drawings that is the result of an Addendum or Change Order, shall identify the Addendum or Change Order from which it originated.
- (2) **Project Manual**
- (a) A copy of all Addenda and Change Orders, excluding drawings thereof, shall be bound in the front of the Project Manual.
- (b) Where a document, form, or entire specification section is revised, the latest issue shall be bound into the Project Manual in the place of the superseded issue.
- (c) Where information within a specification section is revised, the deleted or revised information shall be drawn through in ink and an adjacent note added identifying the Addendum or Change Order containing the revised information.
- C. Within ten days after the Date of Substantial Completion of the Work, or the last completed portion of the Work, the Contractor shall submit the “As-built” documents to the Architect for approval. If the Architect requires that any corrections be made, the documents will be returned in a reasonable time for correction and resubmission.

ARTICLE 12
PROGRESS SCHEDULE

(Not applicable if the Contract Time is 60 days or less.)

- A. The Contractor shall within fifteen days after the date of commencement stated in the Notice to Proceed, or such other time as may be provided in the Contract Documents, prepare and submit to the Architect for review and approval a practicable construction schedule informing the Architect and Owner of the order in which the Contractor plans to carry on the Work within the Contract Time. The Architect's review and approval of the Contractor's construction schedule shall be only for compliance with the specified format, Contract Time, and suitability for monitoring progress of the Work and shall not be construed as a representation that the Architect has analyzed the schedule to form opinions of sequences or durations of time represented in the schedule.
- B. If a schedule format is not specified elsewhere in the Contract Documents, the construction schedule shall be prepared using DCM Form C-11, "Sample Progress Schedule and Report", (contained in the Project Manual) or similar format of suitable scale and detail to indicate the percentage of Work scheduled to be completed at the end of each month. At the end of each month the Contractor shall enter the actual percentage of completion on the construction schedule submit two copies to the Architect, and attach one copy to each copy of the monthly Application for Payment. The construction schedule shall be revised to reflect any agreed extensions of the Contract Time or as required by conditions of the Work.
- C. If a more comprehensive schedule format is specified elsewhere in the Contract Documents or voluntarily employed by the Contractor, it may be used in lieu of DCM Form C-11.
- D. The Contractor's construction schedule shall be used by the Contractor, Architect, and Owner to determine the adequacy of the Contractor's progress. The Contractor shall be responsible for maintaining progress in accordance with the currently approved construction schedule and shall increase the number of shifts, and/or overtime operations, days of work, and/or the amount of construction plant and equipment as may be necessary to do so. If the Contractor's progress falls materially behind the currently approved construction schedule and, in the opinion of the Architect or Owner, the Contractor is not taking sufficient steps to regain schedule, the Architect may, with the Owner's concurrence, issue the Contractor a Notice to Cure pursuant to Article 27. In such a Notice to Cure the Architect may require the Contractor to submit such supplementary or revised construction schedules as may be deemed necessary to demonstrate the manner in which schedule will be regained.

ARTICLE 13
EQUIPMENT, MATERIALS, and SUBSTITUTIONS

- A. Every part of the Work shall be executed in a workmanlike manner in accordance with the Contract Documents and approved Submittals. All materials used in the Work shall be furnished in sufficient quantities to facilitate the proper and expeditious execution of the Work and shall be new except such materials as may be expressly provided or allowed in the Contract Documents to be otherwise.
- B. Whenever a product, material, system, item of equipment, or service is identified in the Contract Documents by reference to a trade name, manufacturer's name, model number, etc.(hereinafter

referred to as “source”), and only one or two sources are listed, or three or more sources are listed and followed by “or approved equal” or similar wording, it is intended to establish a required standard of performance, design, and quality, and the Contractor may submit, for the Architect’s approval, products, materials, systems, equipment, or services of other sources which the Contractor can prove to the Architect’s satisfaction are equal to, or exceed, the standard of performance, design and quality specified, unless the provisions of Paragraph D below apply. Such proposed substitutions are not to be purchased or installed without the Architect’s written approval of the substitution.

- C. If the Contract Documents identify three or more sources for a product, material, system, item of equipment or service to be used and the list of sources is not followed by “or approved equal” or similar wording, the Contractor may make substitution only after evaluation by the Architect and execution of an appropriate Contract Change Order.
- D. If the Contract Documents identify only one source and expressly provide that it is an approved sole source for the product, material, system, item of equipment, or service, the Contractor must furnish the identified sole source.

ARTICLE 14
SAFETY and PROTECTION of PERSONS and PROPERTY

- A. The Contractor shall be solely and completely responsible for conditions at the Project site, including safety of all persons (including employees) and property. The Contractor shall create, maintain, and supervise conditions and programs to facilitate and promote safe execution of the Work, and shall supervise the Work with the attention and skill required to assure its safe performance. Safety provisions shall conform to OSHA requirements and all other federal, state, county, and local laws, ordinances, codes, and regulations. Where any of these are in conflict, the more stringent requirement shall be followed. Nothing contained in this Contract shall be construed to mean that the Owner has employed the Architect nor has the Architect employed its consultants to administer, supervise, inspect, or take action regarding safety programs or conditions at the Project site.
- B. The Contractor shall employ Construction Methods, safety precautions, and protective measures that will reasonably prevent damage, injury or loss to:
 - (1) workers and other persons on the Project site and in adjacent and other areas that may be affected by the Contractor’s operations;
 - (2) the Work and materials and equipment to be incorporated into the Work and stored by the Contractor on or off the Project site; and
 - (3) other property on, or adjacent to, the Project site, including trees, shrubs, lawns, walks, pavements, roadways, structures, utilities, and other improvements not designated in the Contract Documents to be removed, relocated, or replaced.
- C. The Contractor shall be responsible for the prompt remedy of damage and loss to property, including the filing of appropriate insurance claims, caused in whole or in part by the fault or negligence of the Contractor, a Subcontractor, or anyone for whose acts they may be liable.

- D. The Contractor shall comply with and give notices required by applicable laws, ordinances, rules, regulations and lawful orders of public authorities bearing on safety and protection of persons or property, including without limitation notices to adjoining property owners of excavation or other construction activities that potentially could cause damage or injury to adjoining property or persons thereon.
- E. The Contractor shall erect and maintain barriers, danger signs, and any other reasonable safeguards and warnings against hazards as may be required for safety and protection during performance of the Contract and shall notify owners and users of adjacent sites and utilities of conditions that may exist or arise which may jeopardize their safety.
- F. If use or storage of explosives or other hazardous materials or equipment or unusual Construction Methods are necessary for execution of the Work, the Contractor shall exercise commensurate care and employ supervisors and workers properly qualified to perform such activity.
- G. The Contractor shall furnish a qualified safety representative at the Project site whose duties shall include the prevention of accidents. The safety representative shall be the Contractor's superintendent, unless the Contractor assigns this duty to another responsible member of its on-site staff and notifies the Owner and Architect in writing of such assignment.
- H. The Contractor shall not permit a load to be applied, or forces introduced, to any part of the construction or site that may cause damage to the construction or site or endanger safety of the construction, site, or persons on or near the site.
- I. The Contractor shall have the right to act as it deems appropriate in emergency situations jeopardizing life or property. The Contractor shall be entitled to equitable adjustment of the Contract Sum or Contract Time for its efforts expended for the sole benefit of the Owner in an emergency. Such adjustment shall be determined as provided in Articles 19 and 20.
- J. The duty of the Architect and the Architect's consultants to visit the Project site to conduct periodic inspections of the Work or for other purposes shall not give rise to a duty to review or approve the adequacy of the Contractor's safety program, safety supervisor, or any safety measure which Contractor takes or fails to take in, on, or near the Project site.

ARTICLE 15
HAZARDOUS MATERIALS

- A. A Hazardous Material is any substance or material identified as hazardous under any federal, state, or local law or regulation, or any other substance or material which may be considered hazardous or otherwise subject to statutory or regulatory requirements governing its handling, disposal, and/or clean-up. Existing Hazardous Materials are Hazardous Materials discovered at the Project site and not introduced to the Project site by the Contractor, a Subcontractor, or anyone for whose acts they may be liable.
- B. If, during the performance of the Work, the Contractor encounters a suspected Existing Hazardous Material, the Contractor shall immediately stop work in the affected area, take measures appropriate to the condition to keep people away from the suspected Existing Hazardous Material, and

immediately notify the Architect and Owner of the condition in writing.

- C. The Owner shall obtain the services of an independent laboratory or professional consultant, appropriately licensed and qualified, to determine whether the suspected material is a Hazardous Material requiring abatement and, if so, to certify after its abatement that it has been rendered harmless. Any abatement of Existing Hazardous Materials will be the responsibility of the Owner. The Owner will advise the Contractor in writing of the persons or entities who will determine the nature of the suspected material and those who will, if necessary, perform the abatement. The Owner will not employ persons or entities to perform these services to whom the Contractor or Architect has reasonable objection.
- D. After certification by the Owner's independent laboratory or professional consultant that the material is harmless or has been rendered harmless, work in the affected area shall resume upon written agreement between the Owner and Contractor. If the material is found to be an Existing Hazardous Material and the Contractor incurs additional cost or delay due to the presence and abatement of the material, the Contract Sum and/or Contract Time shall be appropriately adjusted by a Contract Change Order pursuant to Article 19.
- E. The Owner shall not be responsible for Hazardous Materials introduced to the Project site by the Contractor, a Subcontractor, or anyone for whose acts they may be liable unless such Hazardous Materials were required by the Contract Documents.

ARTICLE 16 **INSPECTION of the WORK**

A. GENERAL

(1) The Contractor is solely responsible for the Work's compliance with the Contract Documents; therefore, the Contractor shall be responsible to inspect in-progress and completed Work, and shall verify its compliance with the Contract Documents and that any element or portion of the Work upon which subsequent Work is to be applied or performed is in proper condition to receive the subsequent Work. Neither the presence nor absence of inspections by the Architect, Owner, Director, DCM Project Inspector, any public authority having jurisdiction, or their representatives shall relieve the Contractor of responsibility to inspect the Work, for responsibility for Construction Methods and safety precautions and programs in connection with the Work, or from any other requirement of the Contract Documents.

(2) The Architect, Owner, Director, DCM Project Inspector, any public authority having jurisdiction, and their representatives shall have access at all times to the Work for inspection whenever it is in preparation or progress, and the Contractor shall provide proper facilities for such access and inspection. All materials, workmanship, processes of manufacture, and methods of construction, if not otherwise stipulated in the Contract Documents, shall be subject to inspection, examination, and test at any and all places where such manufacture and/or construction are being carried on. Such inspections will not unreasonably interfere with the Contractor's operations.

(3) The Architect will inspect the Work as a representative of the Owner. The Architect's inspections may be supplemented by inspections by the DCM Project Inspector as a representative of the Alabama Division of Construction Management.

(4) The Contractor may be charged by the Owner for any extra cost of inspection incurred by the Owner or Architect on account of material and workmanship not being ready at the time of inspection set by the Contractor.

B. TYPES of INSPECTIONS

(1) SCHEDULED INSPECTIONS and CONFERENCES. Scheduled Inspections and Conferences are conducted by the Architect, scheduled by the Architect in coordination with the Contractor and DCM Project Inspector, and are attended by the Contractor and applicable Subcontractors, suppliers and manufacturers, and the DCM Project Inspector. Scheduled Inspections and Conferences of this Contract include:

(a) **Pre-construction Conference.**

(b) **Pre-roofing Conference** (not applicable if the Contract involves no roofing work)

(c) **Above Ceiling Inspection(s):** An above ceiling inspection of all spaces in the building is required before the ceiling material is installed. Above ceiling inspections are to be conducted at a time when all above ceiling systems are complete and tested to the greatest extent reasonable pending installation of the ceiling material. System identifications and markings are to be complete. All fire-rated construction including fire-stopping of penetrations and specified identification above the ceiling shall be complete. Ceiling framing and suspension systems shall be complete with lights, grilles and diffusers, access panels, fire protection drops for sprinkler heads, etc., installed in their final locations to the greatest extent reasonable. Above ceiling framing to support ceiling mounted equipment shall be complete. The above ceiling construction shall be complete to the extent that after the inspection the ceiling material can be installed without disturbance.

(d) **Final Inspection(s):** A Final Inspection shall establish that the Work, or a designated portion of the Work, is Substantially Complete in accordance with Article 32 and is accepted by the Architect, Owner, and DCM Project Inspector as being ready for the Owner's occupancy or use. At the conclusion of this inspection, items requiring correction or completion ("punch list" items) shall be minimal and require only a short period of time for accomplishment to establish Final Acceptance of the Work. If the Work, or designated portion of the Work, includes the installation, or modification, of a fire alarm system or other life safety systems essential to occupancy, such systems shall have been tested and appropriately certified before the Final Inspection.

(e) **Year-end Inspection(s):** An inspection of the Work, or each separately completed portion thereof, is required near the end of the Contractor's one year warranty period(s). The subsequent delivery of the Architect's report of this inspection will serve as confirmation that the Contractor was notified of Defective Work found within the warranty period in accordance with Article 35.

(2) PERIODIC INSPECTIONS. Periodic Inspections are conducted throughout the course of the Work by the Architect, the Architect's consultants, their representatives, and the DCM Project Inspector, jointly or independently, with or without advance notice to the Contractor.

(3) SPECIFIED INSPECTIONS and TESTS. Specified Inspections and Tests include inspections, tests, demonstrations, and approvals that are either specified in the Contract Documents or required by laws, ordinances, rules, regulations, or orders of public authorities having jurisdiction, to be performed by the Contractor, one of its Subcontractors, or an independent testing laboratory or firm (whether paid for by the Contractor or Owner).

C. INSPECTIONS by the ARCHITECT

- (1) The Architect is not authorized to revoke, alter, relax, or waive any requirements of the Contract Documents (other than “minor” deviations as defined in Article 9 and “minor” changes as defined in Article 19), to finally approve or accept any portion of the Work or to issue instructions contrary to the Contract Documents without concurrence of the Owner.
- (2) The Architect will visit the site at intervals appropriate to the stage of the Contractor’s operations and as otherwise necessary to:
 - (a) become generally familiar with the in-progress and completed Work and the quality of the Work,
 - (b) determine whether the Work is progressing in general accordance with the Contractor’s schedule and is likely to be completed within the Contract Time,
 - (c) visually compare readily accessible elements of the Work to the requirements of the Contract Documents to determine, in general, if the Contractor’s performance of the Work indicates that the Work will conform to the requirements of the Contract Documents when completed,
 - (d) endeavor to guard the Owner against Defective Work,
 - (e) review and address with the Contractor any problems in implementing the requirements of the Contract Documents that the Contractor may have encountered, and
 - (f) keep the Owner fully informed about the Project.
- (3) The Architect shall have the authority to reject Defective Work or require its correction, but shall not be required to make exhaustive investigations or examinations of the in-progress or completed portions of the Work to expose the presence of Defective Work. However, it shall be an obligation of the Architect to report in writing, to the Owner, Contractor, and DCM Project Inspector, any Defective Work recognized by the Architect.
- (4) The Architect shall have the authority to require the Contractor to stop work only when, in the Architect’s reasonable opinion, such stoppage is necessary to avoid Defective Work. The Architect shall not be liable to the Contractor or Owner for the consequences of any decisions made by the Architect in good faith either to exercise or not to exercise this authority.
- (5) “Inspections by the Architect” includes appropriate inspections by the Architect’s consultants as dictated by their respective disciplines of design and the stage of the Contractor’s operations.

D. INSPECTIONS by the DCM PROJECT INSPECTOR

- (1) The DCM Project Inspector will:
 - (a) participate in scheduled inspections and conferences as practicable,
 - (b) perform periodic inspections of in-progress and completed Work to ensure code compliance of the Project and general conformance of the Work with the Contract Documents, and
 - (c) monitor the Contractor's progress and performance of the Work.
- (2) The DCM Project Inspector shall have the authority to:
 - (a) reject Work that is not in compliance with the State Building Code adopted by the DCM, unless the Work is in accordance with the Contract Documents in which case the DCM Project Inspector will advise the Architect to initiate appropriate corrective action, and
 - (b) notify the Architect, Owner, and Contractor of Defective Work recognized by the DCM Project Inspector.

(3) The DCM Project Inspector's periodic inspections will usually be scheduled around key stages of construction based upon information reported by the Architect. As the Architect or Owner deems appropriate, the DCM Project Inspector, as well as other members of the Technical Staff, can be requested to schedule special inspections or meetings to address specific matters. The written findings of DCM Project Inspector will be transmitted to the Owner, Contractor, and Architect.

(4) The DCM Project Inspector is not authorized to revoke, alter, relax, or waive any requirements of the Contract Documents, to finally approve or accept any portion of the Work or to issue instructions contrary to the Contract Documents without concurrence of the Owner. The Contractor shall not proceed with Work as a result of instructions or findings of the DCM Project Inspector which the Contractor considers to be a change to the requirements of the Contract Documents without written authorization of the Owner through the Architect.

E. UNCOVERING WORK

(1) If the Contractor covers a portion of the Work before it is examined by the Architect and this is contrary to the Architect's request or specific requirements in the Contract Documents, then, upon written request of the Architect, the Work must be uncovered for the Architect's examination and be replaced at the Contractor's expense without change in the Contract Time.

(2) Without a prior request or specific requirement that Work be examined by the Architect before it is covered, the Architect may request that Work be uncovered for examination and the Contractor shall uncover it. If the Work is in accordance with the Contract Documents, the Contract Sum shall be equitably adjusted under Article 19 to compensate the Contractor for the costs of uncovering and replacement. If the Work is not in accordance with the Contract Documents, uncovering, correction, and replacement shall be at the Contractor's expense unless the condition was caused by the Owner or a separate contractor in which event the Owner shall be responsible for payment of such costs.

F. SPECIFIED INSPECTIONS and TESTS

(1) The Contractor shall schedule and coordinate Specified Inspections and Tests to be made at appropriate times so as not to delay the progress of the Work or the work of the Owner or separate contractors. If the Contract Documents require that a Specified Inspection or Test be witnessed or attended by the Architect or Architect's consultant, the Contractor shall give the Architect timely notice of the time and place of the Specified Inspection or Test. If a Specified Inspection or Test reveals that Work is not in compliance with requirements of the Contract Documents, the Contractor shall bear the costs of correction, repeating the Specified Inspection or Test, and any related costs incurred by the Owner, including reasonable charges, if any, by the Architect for additional services. Through appropriate Contract Change Order the Owner shall bear costs of tests, inspections or approvals which become Contract requirements subsequent to the receipt of bids.

(2) If the Architect, Owner, or public authority having jurisdiction determines that inspections, tests, demonstrations, or approvals in addition to Specified Inspections and Tests are required, the Contractor shall, upon written instruction from the Architect, arrange for their performance by an entity acceptable to the Owner, giving timely notice to the architect of the time and place of their performance. Related costs shall be borne by the Owner unless the procedures reveal that Work is

not in compliance with requirements of the Contract Documents, in which case the Contractor shall bear the costs of correction, repeating the procedures, and any related costs incurred by the Owner, including reasonable charges, if any, by the Architect for additional services.

(3) Unless otherwise required by the Contract Documents, required certificates of Specified Inspections and Tests shall be secured by the Contractor and promptly delivered to the Architect.

(4) Failure of any materials to pass Specified Inspections and Tests will be sufficient cause for refusal to consider any further samples of the same brand or make of that material for use in the Work.

ARTICLE 17 **CORRECTION of DEFECTIVE WORK**

- A. The Contractor shall, at the Contractor's expense, promptly correct Defective Work rejected by the Architect or which otherwise becomes known to the Contractor, removing the rejected or nonconforming materials and construction from the project site.
- B. Correction of Defective Work shall be performed in such a timely manner as will avoid delay of completion, use, or occupancy of the Work and the work of the Owner and separate contractors.
- C. The Contractor shall bear all expenses related to the correction of Defective Work, including but not limited to: (1) additional testing and inspections, including repeating Specified Inspections and Tests, (2) reasonable services and expenses of the Architect, and (3) the expense of making good all work of the Contractor, Owner, or separate contractors destroyed or damaged by the correction of Defective Work.

ARTICLE 18 **DEDUCTIONS for UNCORRECTED WORK**

If the Owner deems it advisable and in the Owner's interest to accept Defective Work, the Owner may allow part or all of such Work to remain in place, provided an equitable deduction from the Contract Sum, acceptable to the Owner, is offered by the Contractor.

ARTICLE 19 **CHANGES in the WORK**

A. GENERAL

(1) The Owner may at any time direct the Contractor to make changes in the Work which are within the general scope of the Contract, including changes in the Drawings, Specifications, or other portions of the Contract Documents to add, delete, or otherwise revise portions of the Work. The Architect is authorized by the Owner to direct "minor" changes in the Work by written order to the Contractor. "Minor" changes in the Work are defined as those which are in the interest of the Owner, do not materially alter the quality or performance of the finished Work, and do not affect the cost or time of performance of the Work. Changes in the Work which are not "minor" may be

authorized only by the Owner.

- (2) If the Owner directs a change in the Work, the change shall be incorporated into the Contract by a Contract Change Order prepared by the Architect and signed by the Contractor, Owner, and other signatories to the Construction Contract, stating their agreement upon the change or changes in the Work and the adjustments, if any, in the Contract Sum and the Contract Time.
- (3) Subject to compliance with Alabama's Public Works Law, the Owner may, upon agreement by the Contractor, incorporate previously unawarded bid alternates into the Contract.
- (4) In the event of a claim or dispute as to the appropriate adjustment to the Contract Sum or Contract Time due to a directive to make changes in the Work, the Work shall proceed as provided in this article subject to subsequent agreement of the parties or final resolution of the dispute pursuant to Article 24.
- (5) Consent of surety will be obtained for all Contract Change Orders involving an increase in the Contract Sum.
- (6) Changes in the Work shall be performed under applicable provisions of the Contract Documents and the Contractor shall proceed promptly to perform changes in the Work, unless otherwise directed by the Owner through the Architect.
- (7) All change orders require DCM Form C-12: Contract Change Order and DCM Form B-11: Change Order Justification. Only Change Orders 10% or greater of the current contract amount require the Owner's legal advisor's signature on DCM Form B-11: Change Order Justification.

B. DETERMINATION of ADJUSTMENT of the CONTRACT SUM

The adjustment of the Contract Sum resulting from a change in the Work shall be determined by one of the following methods, or a combination thereof, as selected by the Owner:

- (1) **Lump Sum.** By mutual agreement to a lump sum based on or negotiated from an itemized cost proposal from the Contractor. Additions to the Contract Sum shall include the Contractor's direct costs plus a maximum 15% markup for overhead and profit. Where subcontract work is involved the total mark-up for the Contractor and a Subcontractor shall not exceed 25%. **Changes which involve a net credit to the Owner shall include fair and reasonable credits for overhead and profit on the deducted work, in no case less than 5%.** For the purposes of this method of determining an adjustment of the Contract Sum, "overhead" shall cover the Contractor's indirect costs of the change, such as the cost of bonds, superintendent and other job office personnel, watchman, job office, job office supplies and expenses, temporary facilities and utilities, and home office expenses.
- (2) **Unit Price.** By application of Unit Prices included in the Contract or subsequently agreed to by the parties. However, if the character or quantity originally contemplated is materially changed so that application of such unit price to quantities of Work proposed will cause substantial inequity to either party, the applicable unit price shall be equitably adjusted.
- (3) **Force Account.** By directing the Contractor to proceed with the change in the Work on a "force account" basis under which the Contractor shall be reimbursed for reasonable expenditures incurred by the Contractor and its Subcontractors in performing added Work and the Owner shall

receive reasonable credit for any deleted Work. The Contractor shall keep and present, in such form as the Owner may prescribe, an itemized accounting of the cost of the change together with sufficient supporting data. Unless otherwise stated in the directive, the adjustment of the Contract Sum shall be limited to the following:

- (a) costs of labor and supervision, including employee benefits, social security, retirement, unemployment and workers' compensation insurance required by law, agreement, or under Contractor's or Subcontractor's standard personnel policy;
- (b) cost of materials, supplies and equipment, including cost of delivery, whether incorporated or consumed;
- (c) rental cost of machinery and equipment, not to exceed prevailing local rates if contractor-owned;
- (d) costs of premiums for insurance required by the Contract Documents, permit fees, and sales, use or similar taxes related to the change in the Work;
- (e) reasonable credits to the Owner for the value of deleted Work, without Contractor or Subcontractor mark-ups; and
- (f) for additions to the Contract Sum, mark-up of the Contractor's direct costs for overhead and profit not exceeding 15% on Contractor's work nor exceeding 25% for Contractor and Subcontractor on a Subcontractor's work. **Changes which involve a net credit to the Owner shall include fair and reasonable credits for overhead and profit on the deducted work, in no case less than 5%.** For the purposes of this method of determining an adjustment of the Contract Sum, "overhead" shall cover the Contractor's indirect costs of the change, such as the cost of insurance other than mentioned above, bonds, superintendent and other job office personnel, watchman, use and rental of small tools, job office, job office supplies and expenses, temporary facilities and utilities, and home office expenses.

C. ADJUSTMENT of the CONTRACT TIME due to CHANGES

(1) Unless otherwise provided in the Contract Documents, the Contract Time shall be equitably adjusted for the performance of a change provided that the Contractor notifies the Architect in writing that the change will increase the time required to complete the Work. Such notice shall be provided no later than:

- (a) with the Contractor's cost proposal stating the number of days of extension requested, or
- (b) within ten days after the Contractor receives a directive to proceed with a change in advance of submitting a cost proposal, in which case the notice should provide an estimated number of days of extension to be requested, which may be subject to adjustment in the cost proposal.

(2) The Contract Time shall be extended only to the extent that the change affects the time required to complete the entire Work of the Contract, taking into account the concurrent performance of the changed and unchanged Work.

D. CHANGE ORDER PROCEDURES

(1) If the Owner proposes to make a change in the Work, the Architect will request that the Contractor provide a cost proposal for making the change to the Work. The request shall be in writing and shall adequately describe the proposed change using drawings, specifications, narrative, or a combination thereof. Within 21 days after receiving such a request, or such other time as may be stated in the request, the Contractor shall prepare and submit to the Architect a written proposal, properly itemized and supported by sufficient substantiating data to facilitate evaluation. The stated

time within which the Contractor must submit a proposal may be extended if, within that time, the Contractor makes a written request with reasonable justification thereof.

(2) The Contractor may voluntarily offer a change proposal which, in the Contractor's opinion, will reduce the cost of construction, maintenance, or operation or will improve the cost-effective performance of an element of the Project, in which case the Owner, through the Architect, will accept, reject, or respond otherwise within 21 days after receipt of the proposal, or such other reasonable time as the Contractor may state in the proposal.

(3) If the Contractor's proposal is acceptable to the Owner, or is negotiated to the mutual agreement of the Contractor and Owner, the Architect will prepare an appropriate Contract Change Order for execution. Upon receipt of the fully executed Contract Change Order, the Contractor shall proceed with the change.

(4) In advance of delivery of a fully executed Contract Change Order, the Architect may furnish to the Contractor a written authorization to proceed with an agreed change. However, such an authorization shall be effective only if it:

- (a) identifies the Contractor's accepted or negotiated proposal for the change,
- (b) states the agreed adjustments, if any, in Contract Sum and Contract Time,
- (c) states that funds are available to pay for the change, and
- (d) is signed by the Owner.

(5) If the Contractor and Owner cannot agree on the amount of the adjustment in the Contract Sum for a change, the Owner, through the Architect, may order the Contractor to proceed with the change on a Force Account basis, but the net cost to the Owner shall not exceed the amount quoted in the Contractor's proposal. Such order shall state that funds are available to pay for the change.

(6) If the Contractor does not promptly respond to a request for a proposal, or the Owner determines that the change is essential to the final product of the Work and that the change must be effected immediately to avoid delay of the Project, the Owner may:

- (a) determine with the Contractor a sufficient maximum amount to be authorized for the change and
- (b) direct the Contractor to proceed with the change on a Force Account basis pending delivery of the Contractor's proposal, stating the maximum increase in the Contract Sum that is authorized for the change.

(7) Pending agreement of the parties or final resolution of any dispute of the total amount due the Contractor for a change in the Work, amounts not in dispute for such changes in the Work may be included in Applications for Payment accompanied by an interim Change Order indicating the parties' agreement with part of all of such costs or time extension. Once a dispute is resolved, it shall be implemented by preparation and execution of an appropriate Change Order.

ARTICLE 20

CLAIMS for EXTRA COST or EXTRA WORK

- A. If the Contractor considers any instructions by the Architect, Owner, DCM Project Inspector, or public authority having jurisdiction to be contrary to the requirements of the Contract Documents and will involve extra work and/or cost under the Contract, the Contractor shall give the Architect

written notice thereof within ten days after receipt of such instructions, and in any event before proceeding to execute such work. As used in this Article, "instructions" shall include written or oral clarifications, directions, instructions, interpretations, or determinations.

- B. The Contractor's notification pursuant to Paragraph 20.A shall state: (1) the date, circumstances, and source of the instructions, (2) that the Contractor considers the instructions to constitute a change to the Contract Documents and why, and (3) an estimate of extra cost and time that may be involved to the extent an estimate may be reasonably made at that time.
- C. Except for claims relating to an emergency endangering life or property, no claim for extra cost or extra work shall be considered in the absence of prior notice required under Paragraph 20.A.
- D. Within ten days of receipt of a notice pursuant to Paragraph 20.A, the Architect will respond in writing to the Contractor, stating one of the following:
 - (1) The cited instruction is rescinded.
 - (2) The cited instruction is a change in the Work and in which manner the Contractor is to proceed with procedures of Article 19, Changes in the Work.
 - (3) The cited instruction is reconfirmed, is not considered by the Architect to be a change in the Contract Documents, and the Contractor is to proceed with Work as instructed.
- E. If the Architect's response to the Contractor is as in Paragraph 20.D(3), the Contractor shall proceed with the Work as instructed. If the Contractor continues to consider the instructions to constitute a change in the Contract Documents, the Contractor shall, within ten days after receiving the Architect's response, notify the Architect in writing that the Contractor intends to submit a claim pursuant to Article 24, Resolution of Claims and Disputes

ARTICLE 21

DIFFERING SITE CONDITIONS

A. DEFINITION

"Differing Site Conditions" are:

- (1) subsurface or otherwise concealed physical conditions at the Project site which differ materially from those indicated in the Contract Documents, or
- (2) unknown physical conditions at the Project site which are of an unusual nature, differing materially from conditions ordinarily encountered and generally recognized as inherent in construction activities of the character required by the Contract Documents.

B. PROCEDURES

If Differing Site Conditions are encountered, then the party discovering the condition shall promptly notify the other party before the condition is disturbed and in no event later than ten days after discovering the condition. Upon such notice and verification that a Differing Site Condition exists, the Architect will, with reasonable promptness and with the Owner's concurrence, make changes in the Drawings and/or Specifications as are deemed necessary to conform to the Differing

Site Condition. Any increase or decrease in the Contract Sum or Contract Time that is warranted by the changes will be made as provided under Article 19, Changes in the Work. If the Architect determines a Differing Site Condition has not been encountered, the Architect shall notify the Owner and Contractor in writing, stating the reason for that determination.

ARTICLE 22 **CLAIMS for DAMAGES**

If either party to the Contract suffers injury or damage to person or property because of an act or omission of the other party, or of others for whose acts such party is legally responsible, written notice of such injury or damage, whether or not insured, shall be given to the other party within a reasonable time after the discovery. The notice shall provide sufficient detail to enable the other party to investigate the matter.

ARTICLE 23 **DELAYS**

- A. A delay beyond the Contractor's control at any time in the commencement or progress of Work by an act or omission of the Owner, Architect, or any separate contractor or by labor disputes, unusual delay in deliveries, unavoidable casualties, fires, abnormal floods, tornadoes, or other cataclysmic events of nature, may entitle the Contractor to an extension of the Contract Time provided, however, that the Contractor shall, within ten days after the delay first occurs, give written notice to the Architect of the cause of the delay and its probable effect on progress of the entire Work.
- B. Adverse weather conditions that are more severe than anticipated for the locality of the Work during any given month may entitle the Contractor to an extension of Contract Time provided, however;
 - (1) the weather conditions had an adverse effect on construction scheduled to be performed during the period in which the adverse weather occurred, which in reasonable sequence would have an effect on completion of the entire Work,
 - (2) the Contractor shall, within twenty-one days after the end of the month in which the delay occurs, give the Architect written notice of the delay that occurred during that month and its probable effect on progress of the Work, and
 - (3) within a reasonable time after giving notice of the delay, the Contractor provides the Architect with sufficient data to document that the weather conditions experienced were unusually severe for the locality of the Work during the month in question. Unless otherwise provided in the Contract Documents, data documenting unusually severe weather conditions shall compare actual weather conditions to the average weather conditions for the month in question during the previous five years as recorded by the National Oceanic and Atmospheric Administration (NOAA) or similar record-keeping entities.
- C. Adjustments, if any, of the Contract Time pursuant to this Article shall be incorporated into the Contract by a Contract Change Order prepared by the Architect and signed by the Contractor, Owner, and other signatories to the Construction Contract or, at closeout of the Contract, by mutual

written agreement between the Contractor and Owner. The adjustment of the Contract Time shall not exceed the extent to which the delay extends the time required to complete the entire Work of the Contract.

- D. The Contractor shall not be entitled to any adjustment of the Contract Sum for damage due to delays claimed pursuant to this Article unless the delay was caused by the Owner or Architect and was either:
- (1) the result of bad faith or active interference or
 - (2) beyond the contemplation of the parties and not remedied within a reasonable time after notification by the Contractor of its presence.

ARTICLE 24 **RESOLUTION of CLAIMS and DISPUTES**

A. APPLICABILITY of ARTICLE

(1) As used in this Article, "Claims and Disputes" include claims or disputes asserted by the Contractor, its Surety, or Owner arising out of or related to the Contract, or its breach, including without limitation claims seeking, under the provisions of the Contract, equitable adjustment of the Contract Sum or Contract Time and claims and disputes arising between the Contractor (or its Surety) and Owner regarding interpretation of the Contract Documents, performance of the Work, or breach of or compliance with the terms of the Contract.

(2) "Resolution" addressed in this Article applies only to Claims and Disputes arising between the Contractor (or its Surety) and Owner and asserted after execution of the Construction Contract and prior to the date upon which final payment is made. Upon making application for final payment the Contractor may reserve the right to subsequent Resolution of existing Claims by including a list of all Claims, in stated amounts, which remain to be resolved and specifically excluding them from any release of claims executed by the Contractor, and in that event Resolution may occur after final payment is made.

B. CONTINUANCE of PERFORMANCE

An unresolved Claim or Dispute shall not be just cause for the Contractor to fail or refuse to proceed diligently with performance of the Contract or for the Owner to fail or refuse to continue to make payments in accordance with the Contract Documents.

C. GOOD FAITH EFFORT to SETTLE

The Contractor and Owner agree that, upon the assertion of a Claim by the other, they will make a good faith effort, with the Architect's assistance and advice, to achieve mutual resolution of the Claim. If mutually agreed, the Contractor and Owner may endeavor to resolve a Claim through mediation. If efforts to settle are not successful, the Claim shall be resolved in accordance with paragraph D or E below, whichever applies.

D. FINAL RESOLUTION for STATE-FUNDED CONTRACTS

(1) If the Contract is funded in whole or in part with state funds, the final Resolution of Claims

and Disputes which cannot be resolved by the Contractor (or its Surety) and Owner shall be by the Director, whose decision shall be final, binding, and conclusive upon the Contractor, its Surety, and the Owner.

(2) When it becomes apparent to the party asserting a Claim (the Claimant) that an impasse to mutual resolution has been reached, the Claimant may request in writing to the Director that the Claim be resolved by decision of the Director. Such request by the Contractor (or its Surety) shall be submitted through the Owner. Should the Owner fail or refuse to submit the Contractor's request within ten days of receipt of same, the Contractor may forward such request directly to the Director. Upon receipt of a request to resolve a Claim, the Director will instruct the parties as to procedures to be initiated and followed.

(3) If the respondent to a Claim fails or refuses to participate or cooperate in the Resolution procedures to the extent that the Claimant is compelled to initiate legal proceedings to induce the Respondent to participate or cooperate, the Claimant will be entitled to recover, and may amend its Claim to include, the expense of reasonable attorney's fees so incurred.

E. FINAL RESOLUTION for LOCALLY-FUNDED CONTRACTS

If the Contract is funded in whole with funds provided by a city or county board of education or other local governmental authority and the Contract Documents do not stipulate a binding alternative dispute resolution method, the final resolution of Claims and Disputes which cannot be resolved by the Contractor (or its Surety) and Owner may be by any legal remedy available to the parties. Alternatively, upon the written agreement of the Contractor (or its Surety) and the Owner, final Resolution of Claims and Disputes may be by submission to binding arbitration before a neutral arbitrator or panel or by submission to the Director in accordance with preceding Paragraph D.

ARTICLE 25
OWNER'S RIGHT to CORRECT DEFECTIVE WORK

If the Contractor fails or refuses to correct Defective Work in a timely manner that will avoid delay of completion, use, or occupancy of the Work or work by the Owner or separate contractors, the Architect may give the Contractor written Notice to Cure the Defective Work within a reasonable, stated time. If within ten days after receipt of the Notice to Cure the Contractor has not proceeded and satisfactorily continued to cure the Defective Work or provided the Architect with written verification that satisfactory positive action is in process to cure the Defective Work, the Owner may, without prejudice to any other remedy available to the Owner, correct the Defective Work and deduct the actual cost of the correction from payment then or thereafter due to the Contractor.

ARTICLE 26
OWNER'S RIGHT to STOP or SUSPEND the WORK

A. STOPPING the WORK for CAUSE

If the Contractor fails to correct Defective Work or persistently fails to carry out Work in accordance with the Contract Documents, the Owner may direct the Contractor in writing to stop the Work, or any part of the Work, until the cause for the Owner's directive has been eliminated;

however, the Owner's right to stop the Work shall not be construed as a duty of the Owner to be exercised for the benefit of the Contractor or any other person or entity.

B. SUSPENSION by the OWNER for CONVENIENCE

(1) The Owner may, at any time and without cause, direct the Contractor in writing to suspend, delay or interrupt the Work, or any part of the Work, for a period of time as the Owner may determine.

(2) The Contract Sum and Contract Time shall be adjusted, pursuant to Article 19, for reasonable increases in the cost and time caused by an Owner-directed suspension, delay or interruption of Work for the Owner's convenience. However, no adjustment to the Contract Sum shall be made to the extent that the same or concurrent Work is, was or would have been likewise suspended, delayed or interrupted for other reasons not caused by the Owner.

ARTICLE 27
OWNER'S RIGHT to TERMINATE CONTRACT

A. TERMINATION by the OWNER for CAUSE

(1) **Causes:** The Owner may terminate the Contractor's right to complete the Work, or any designated portion of the Work, if the Contractor:

- (a) should be adjudged bankrupt, or should make a general assignment for the benefit of the Contractor's creditors, or if a receiver should be appointed on account of the Contractor's insolvency to the extent termination for these reasons is permissible under applicable law;
- (b) refuses or fails to prosecute the Work, or any part of the Work, with the diligence that will insure its completion within the Contract Time, including any extensions, or fails to complete the Work within the Contract Time;
- (c) refuses or fails to perform the Work, including prompt correction of Defective Work, in a manner that will insure that the Work, when fully completed, will be in accordance with the Contract Documents;
- (d) fails to pay for labor or materials supplied for the Work or to pay Subcontractors in accordance with the respective Subcontract;
- (e) persistently disregards laws, ordinances, or rules, regulations or orders of a public authority having jurisdiction, or the instructions of the Architect or Owner; or
- (f) is otherwise guilty of a substantial breach of the Contract.

(2) **Procedure for Unbonded Construction Contracts (Generally, contracts less than \$50,000):**

- (a) **Notice to Cure:** In the presence of any of the above conditions the Architect may give the Contractor written notice to cure the condition within a reasonable, stated time, but not less than ten days after the Contractor receives the notice.
- (b) **Notice of Termination:** If, at the expiration of the time stated in the Notice to Cure, the Contractor has not proceeded and satisfactorily continued to cure the condition or provided the Architect with written verification that satisfactory positive action is in process to cure the condition, the Owner may, without prejudice to any other rights or remedies of the Owner, give the Contractor written notice that the Contractor's right to complete the Work, or a designated portion of the Work, shall terminate seven days after the Contractor's receipt of the

written Notice of Termination.

(c) If the Contractor satisfies a Notice to Cure, but the condition for which the notice was first given reoccurs, the Owner may give the Contractor a seven day Notice of Termination without giving the Contractor another Notice to Cure.

(d) At the expiration of the seven days of the termination notice, the Owner may:

.1 take possession of the site, of all materials and equipment stored on and off site, and of all Contractor-owned tools, construction equipment and machinery, and facilities located at the site, and

.2 finish the Work by whatever reasonable method the Owner may deem expedient.

(e) The Contractor shall not be entitled to receive further payment under the Contract until the Work is completed.

(f) If the Owner's cost of completing the Work, including correction of Defective Work, compensation for additional architectural, engineering, managerial, and administrative services, and reasonable attorneys' fees due to the default and termination, is less than the unpaid balance of the Contract Sum, the excess balance less liquidated damages for delay shall be paid to the Contractor. If such cost to the Owner including attorney's fees, plus liquidated damages, exceeds the unpaid balance of the Contract Sum, the Contractor shall pay the difference to the Owner. Final Resolution of any claim or Dispute involving the termination or any amount due any party as a result of the termination shall be pursuant to Article 24.

(g) Upon the Contractor's request, the Owner shall furnish to the Contractor a detailed accounting of the Owner's cost of completing the Work.

(3) Procedure for Bonded Construction Contracts (Generally, contracts over \$50,000):

(a) **Notice to Cure:** In the presence of any of the above conditions the Architect may give the Contractor and its Surety written Notice to Cure the condition within a reasonable, stated time, but not less than ten days after the Contractor receives the notice.

(b) **Notice of Termination:** If, at the expiration of the time stated in the Notice to Cure, the Contractor has not proceeded and satisfactorily continued to cure the condition or provided the Architect with written verification that satisfactory positive action is in process to cure the condition, the Owner may, without prejudice to any other rights or remedies of the Owner, give the Contractor and its Surety written notice declaring the Contractor to be in default under the Contract and stating that the Contractor's right to complete the Work, or a designated portion of the Work, shall terminate seven days after the Contractor's receipt of the written Notice of Termination.

(c) If the Contractor satisfies a Notice to Cure, but the condition for which the notice was first given reoccurs, the Owner may give the Contractor a Notice of Termination without giving the Contractor another Notice to Cure.

(d) **Demand on the Performance Bond:** With the Notice of Termination the Owner shall give the Surety a written demand that, upon the effective date of the Notice of Termination, the Surety promptly fulfill its obligation to take charge of and complete the Work in accordance with the terms of the Performance Bond.

(e) **Surety Claims:** Upon receiving the Owner's demand on the Performance Bond, the Surety shall assume all rights and obligations of the Contractor under the Contract. However, the Surety shall also have the right to assert "Surety Claims" to the Owner, which are defined as claims relating to acts or omissions of the Owner or Architect prior to termination of the Contractor which may have prejudiced its rights as Surety or its interest in the unpaid balance of the Contract Sum. If the Surety wishes to assert a Surety Claim, it shall give the Owner, through the Architect, written notice within twenty-one days after first recognizing the

condition giving rise to the Surety Claim. The Surety Claim shall then be submitted to the Owner, through the Architect, no later than sixty days after giving notice thereof, but no such Surety Claims shall be considered if submitted after the date upon which final payment becomes due. Final resolution of Surety Claims shall be pursuant to Article 24, Resolution of Claims and Disputes. The presence or possibility of a Surety Claim shall not be just cause for the Surety to fail or refuse to take charge of and complete the Work or for the Owner to fail or refuse to continue to make payments in accordance with the Contract Documents.

(f) Payments to Surety: The Surety shall be paid for completing the Work in accordance with the Contract Documents as if the Surety were the Contractor. The Owner shall have the right to deduct from payments to the Surety any reasonable costs incurred by the Owner, including compensation for additional architectural, engineering, managerial, and administrative services, and attorneys' fees as necessitated by termination of the Contractor and completion of the Work by the Surety. No further payments shall be made to the Contractor by the Owner. The Surety shall be solely responsible for any accounting to the Contractor for the portion of the Contract Sum paid to Surety by Owner or for the costs and expenses of completing the Work.

(4) Wrongful Termination: If any notice of termination by the Owner for cause, made in good faith, is determined to have been wrongly given, such termination shall be effective and compensation therefore determined as if it had been a termination for convenience pursuant to Paragraph B below.

B. TERMINATION by the OWNER for CONVENIENCE

(1) The Owner may, without cause and at any time, terminate the performance of Work under the Contract in whole, or in part, upon determination by the Owner that such termination is in the Owner's best interest. Such termination is referred to herein as Termination for Convenience.

(2) Upon receipt of a written notice of Termination for Convenience from the Owner, the Contractor shall:

- (a)** stop Work as specified in the notice;
- (b)** enter into no further subcontracts or purchase orders for materials, services, or facilities, except as may be necessary for Work directed to be performed prior to the effective date of the termination or to complete Work that is not terminated;
- (c)** terminate all existing subcontracts and purchase orders to the extent they relate to the terminated Work;
- (d)** take such actions as are necessary, or directed by the Architect or Owner, to protect, preserve, and make safe the terminated Work; and
- (e)** complete performance of the Work that is not terminated.

(3) In the event of Termination for Convenience, the Contractor shall be entitled to receive payment for the Work performed prior to its termination, including materials and equipment purchased and delivered for incorporation into the terminated Work, and any reasonable costs incurred because of the termination. Such payment shall include reasonable mark-up of costs for overhead and profit, not to exceed the limits stated in Article 19, Changes in the Work. The Contractor shall be entitled to receive payment for reasonable anticipated overhead ("home office") and shall not be entitled to receive payment for any profits anticipated to have been gained from the terminated Work. A proposal for decreasing the Contract Sum shall be submitted to the Architect by the Contractor in such time and detail, and with such supporting documentation, as is reasonably

directed by the Owner. Final modification of the Contract shall be by Contract Change Order pursuant to Article 19. Any Claim or Dispute involving the termination or any amount due a party as a result shall be resolved pursuant to Article 24.

ARTICLE 28
CONTRACTOR'S RIGHT to SUSPEND or TERMINATE the CONTRACT

A. SUSPENSION by the OWNER

If all of the Work is suspended or delayed for the Owner's convenience or under an order of any court, or other public authority, for a period of sixty days, through no act or fault of the Contractor or a Subcontractor, or anyone for whose acts they may be liable, then the Contractor may give the Owner a written Notice of Termination which allows the Owner fourteen days after receiving the Notice in which to give the Contractor appropriate written authorization to resume the Work. Absent the Contractor's receipt of such authorization to resume the Work, the Contract shall terminate upon expiration of this fourteen day period and the Contractor will be compensated by the Owner as if the termination had been for the Owner's convenience pursuant to Article 27.B.

B. NONPAYMENT

The Owner's failure to pay the undisputed amount of an Application for Payment within sixty days after receiving it from the Architect (Certified pursuant to Article 30) shall be just cause for the Contractor to give the Owner fourteen days' written notice that the Work will be suspended pending receipt of payment but that the Contract shall terminate if payment is not received within fourteen days (or a longer period stated by the Contractor) of the expiration of the fourteen day notice period.

(1) If the Work is then suspended for nonpayment, but resumed upon receipt of payment, the Contractor will be entitled to compensation as if the suspension had been by the Owner pursuant to Article 26, Paragraph B.

(2) If the Contract is then terminated for nonpayment, the Contractor will be entitled to compensation as if the termination had been by the Owner pursuant to Article 27, Paragraph B.

ARTICLE 29
PROGRESS PAYMENTS

A. FREQUENCY of PROGRESS PAYMENTS

Unless otherwise provided in the Contract Documents, the Owner will make payments to the Contractor as the Work progresses based on monthly estimates prepared and certified by the Contractor, approved and certified by the Architect, and approved by the Owner and other authorities whose approval is required.

B. SCHEDULE of VALUES

Within ten days after receiving the Notice to Proceed the Contractor shall submit to the Architect a

DCM Form C-10SOV, Schedule of Values, which is a breakdown of the Contract Sum showing the value of the various parts of the Work for billing purposes. The Schedule of Values shall be printable on 8.5" × 11" for DCM's scanning purposes and shall divide the Contract Sum into as many parts ("line items") as the Architect and Owner determine necessary to permit evaluation and to show amounts attributable to Subcontractors. The Contractor's overhead and profit are to be proportionately distributed throughout the line items of the Schedule of Values. Upon approval, the Schedule of Values shall be used as a basis for monthly Applications for Payment, unless it is later found to be in error. Approved change order amounts shall be added to or incorporated into the Schedule of Values as mutually agreed by the Contractor and Architect.

C. APPLICATIONS for PAYMENTS

(1) Based on the approved Schedule of Values, each DCM Form C-10, Application and Certificate for Payment shall show the Contractor's estimate of the value of Work performed in each line item as of the end of the billing period. The Contractor's cost of materials and equipment not yet incorporated into the Work, but delivered and suitably stored on the site, may be considered in monthly Applications for Payment. One payment application per month may be submitted. Each DCM Form C-10, Application and Certificate for Payment shall match to the penny and be accompanied by an attached DCM Form C-10SOV, Schedule of Values.

(2) The Contractor's estimate of the value of Work performed and stored materials must represent such reasonableness as to warrant certification by the Architect to the Owner in accordance with Article 30. Each monthly Application for Payment shall be supported by such data as will substantiate the Contractor's right to payment, including without limitation copies of requisitions from subcontractors and material suppliers.

(3) If no other date is stated in the Contract Documents or agreed upon by the parties, each Application for Payment shall be submitted to the Architect on or about the first day of each month and payment shall be issued to the Contractor within thirty days after an Application for Payment is Certified pursuant to Article 30 and delivered to the Owner.

(4) Four copies of DCM Form C-10, Application and Certificate for Payment containing original signatures, with each copy of DCM Form C-10 to include all attachments, shall be submitted to DCM for review following the Contractor's, Notary's, Architect's and Owner's signatures.

D. MATERIALS STORED OFF SITE

Unless otherwise provided in the Contract Documents, the Contractor's cost of materials and equipment to be incorporated into the Work, which are stored off the site, may also be considered in monthly Applications for Payment under the following conditions:

- (1) the contractor has received written approval from the Architect and Owner to store the materials or equipment off site in advance of delivering the materials to the off site location;
- (2) a Certificate of Insurance is furnished to the Architect evidencing that a special insurance policy, or rider to an existing policy, has been obtained by the Contractor providing all-risk property insurance coverage, specifically naming the materials or equipment stored, and naming the Owner as an additionally insured party;
- (3) the Architect is provided with a detailed inventory of the stored materials or equipment and the materials or equipment are clearly marked in correlation to the inventory to facilitate inspection and verification of the presence of the materials or equipment by the Architect or

- Owner;
- (4) the materials or equipment are properly and safely stored in a bonded warehouse, or a facility otherwise approved in advance by the Architect and Owner; and
 - (5) compliance by the Contractor with procedures satisfactory to the Owner to establish the Owner's title to such materials and equipment or otherwise protect the Owner's interest.

E. RETAINAGE

(1) "Retainage" is defined as the money earned and, therefore, belonging to the Contractor (subject to final settlement of the Contract) which has been retained by the Owner conditioned on final completion and acceptance of all Work required by the Contract Documents. Retainage shall not be relied upon by Contractor (or Surety) to cover or off-set unearned monies attributable to uncompleted or uncorrected Work.

(2) In making progress payments the Owner shall retain five percent of the estimated value of Work performed and the value of the materials stored for the Work; but after retainage has been held upon fifty percent of the Contract Sum, no additional retainage will be withheld.

F. CONTRACTOR'S CERTIFICATION

(1) Each Application for Payment shall bear the Contractor's notarized certification that, to the best of the Contractor's knowledge, information, and belief, the Work covered by the Application for Payment has been completed in accordance with the Contract Documents, that all amounts have been paid by the Contractor for Work for which previous Certificates for Payments were issued and payments received from the Owner and that the current payment shown in the Application for Payment has not yet been received.

(2) By making this certification the Contractor represents to the Architect and Owner that, upon receipt of previous progress payments from the Owner, the Contractor has promptly paid each Subcontractor, in accordance with the terms of its agreement with the Subcontractor, the amount due the Subcontractor from the amount included in the progress payment on account of the Subcontractor's Work and stored materials. The Architect and Owner may advise Subcontractors and suppliers regarding percentages of completion or amounts requested and/or approved in an Application for Payment on account of the Subcontractor's Work and stored materials.

G. PAYMENT ESTABLISHES OWNERSHIP

All material and Work covered by progress payments shall become the sole property of the Owner, but the Contractor shall not be relieved from the sole responsibility for the care and protection of material and Work upon which payments have been made and for the restoration of any damaged material and Work.

ARTICLE 30
CERTIFICATION and APPROVALS for PAYMENT

- A. The Architect's review, approval, and certification of Applications for Payment shall be based on the Architect's general knowledge of the Work obtained through site visits and the information provided by the Contractor with the Application. The Architect shall not be required to perform

exhaustive examinations, evaluations, or estimates of the cost of completed or uncompleted Work or stored materials to verify the accuracy of amounts requested by the Contractor, but the Architect shall have the authority to adjust the Contractor's estimate when, in the Architect's reasonable opinion, such estimates are overstated or understated.

- B.** Within seven days after receiving the Contractor's monthly Application for Payment, or such other time as may be stated in the Contract Documents, the Architect will take one of the following actions:
- (1)** The Architect will approve and certify the Application as submitted and forward it to the Owner as a Certification for Payment for approval by the Owner (and other approving authorities, if any) and payment.
 - (2)** If the Architect takes exception to any amounts claimed by the Contractor and the Contractor and Architect cannot agree on revised amounts, the Architect will promptly issue a Certificate for Payment for the amount for which the Architect is able to certify to the Owner, transmitting a copy of same to the Contractor.
 - (3)** To the extent the Architect determines may be necessary to protect the Owner from loss on account of any of the causes stated in Article 31, the Architect may subtract from the Contractor's estimates and will issue a Certificate for Payment to the Owner, with a copy to the Contractor, for such amount as the Architect determines is properly due and notify the Contractor and Owner in writing of the Architect's reasons for withholding payment in whole or in part.
- C.** Neither the Architect's issuance of a Certificate for Payment nor the Owner's resulting progress payment shall be a representation to the Contractor that the Work in progress or completed at that time is accepted or deemed to be in conformance with the Contract Documents.
- D.** The Architect shall not be required to determine that the Contractor has promptly or fully paid Subcontractors and suppliers or how or for what purpose the Contractor has used monies paid under the Construction Contract. However, the Architect may, upon request and if practical, inform any Subcontractor or supplier of the amount, or percentage of completion, approved or paid to the Contractor on account of the materials supplied or the Work performed by the Subcontractor.

ARTICLE 31 **PAYMENTS WITHHELD**

- A.** The Architect may nullify or revise a previously issued Certificate for Payment prior to Owner's payment thereunder to the extent as may be necessary in the Architect's opinion to protect the Owner from loss on account of any of the following causes not discovered or fully accounted for at the time of the certification or approval of the Application for Payment:
- (1)** Defective Work;
 - (2)** filed, or reasonable evidence indicating probable filing of, claims arising out of the Contract by other parties against the Contractor;
 - (3)** the Contractor's failure to pay for labor, materials or equipment or to pay Subcontractors;
 - (4)** reasonable evidence that the Work cannot be completed for the unpaid balance of the Contract Sum;
 - (5)** damage suffered by the Owner or another contractor caused by the Contractor, a

- Subcontractor, or anyone for whose acts they may be liable;
- (6) reasonable evidence that the Work will not be completed within the Contract Time, and that the unpaid balance is insufficient to cover applicable liquidated damages; or
 - (7) the Contractor's persistent failure to conform to the requirements of the Contract Documents.
- B. If the Owner deems it necessary to withhold payment pursuant to preceding Paragraph A, the Owner will notify the Contractor and Architect in writing of the amount to be withheld and the reason for same.
- C. The Architect shall not be required to withhold payment for completed or partially completed Work for which compliance with the Contract Documents remains to be determined by Specified Inspections or Final Inspections to be performed in their proper sequence. However, if Work for which payment has been approved, certified, or made under an Application for Payment is subsequently determined to be Defective Work, the Architect shall determine an appropriate amount that will protect the Owner's interest against the Defective Work.
- (1) If payment has not been made against the Application for Payment first including the Defective Work, the Architect will notify the Owner and Contractor of the amount to be withheld from the payment until the Defective Work is brought into compliance with the Contract Documents.
 - (2) If payment has been made against the Application for Payment first including the Defective Work, the Architect will withhold the appropriate amount from the next Application for Payment submitted after the determination of noncompliance, such amount to then be withheld until the Defective Work is brought into compliance with the Contract Documents.
- D. The amount withheld will be paid with the next Application for Payment certified and approved after the condition for which the Owner has withheld payment is removed or otherwise resolved to the Owner's satisfaction.
- E. The Owner shall have the right to withhold from payments due the Contractor under this Contract an amount equal to any amount which the Contractor owes the Owner under another contract.

ARTICLE 32

SUBSTANTIAL COMPLETION

- A. Substantial Completion is the stage in the progress of the Work when the Work or designated portion of the Work is sufficiently complete in accordance with the Contract Documents so that the Owner can occupy or utilize the Work for its intended use without disruption or interference by the Contractor in completing or correcting any remaining unfinished Work ("punch list" items). Substantial Completion of the Work, or a designated portion of the Work, is not achieved until so agreed in a Certificate of Substantial Completion signed by the Contractor, Architect, Owner, and Technical Staff of the Alabama Division of Construction Management.
- B. The Contractor shall notify the Architect in writing when it considers the Work, or a portion of the Work which the Owner has agreed to accept separately, to be substantially complete and ready for a Final Inspection pursuant to Article 16. In this notification the Contractor shall identify any items remaining to be completed or corrected for Final Acceptance prior to final payment.

- C. Substantial Completion is achieved and a Final Inspection is appropriate only when a minimal number of punch list items exists and only a short period of time will be required to correct or complete them. Upon receipt of the Contractor's notice for a Final Inspection, the Architect will advise the Contractor in writing of any conditions of the Work which the Architect or Owner is aware do not constitute Substantial Completion, otherwise, a Final Inspection will proceed within a reasonable time after the Contractor's notice is given. However, the Architect will not be required to prepare lengthy listings of punch list items; therefore, if the Final Inspection discloses that Substantial Completion has not been achieved, the Architect may discontinue or suspend the inspection until the Contractor does achieve Substantial Completion.

D. CERTIFICATE of SUBSTANTIAL COMPLETION

- (1) When the Work or a designated portion of the Work is substantially complete, the Architect will prepare and sign a Certificate of Substantial Completion to be signed in order by the Contractor, Owner, and Alabama Division of Construction Management.
- (2) When signed by all parties, the Certificate of Substantial Completion shall establish the Date of Substantial Completion which is the date upon which:
- (a) the Work, or designated portion of the Work, is accepted by the Architect, Owner, and Alabama Division of Construction Management as being ready for occupancy,
 - (b) the Contractor's one-year and special warranties for the Work covered by the Certificate commence, unless stated otherwise in the Certificate (the one-year warranty for punch list items completed or corrected after the period allowed in the Certificate shall commence on the date of their Final Acceptance), and
 - (c) Owner becomes responsible for building security, maintenance, utility services, and insurance, unless stated otherwise in the Certificate.
- (3) The Certificate of Substantial Completion shall set the time within which the Contractor shall finish all items on the "punch list" accompanying the Certificate. The completion of punch list items shall be a condition precedent to Final Payment.
- (4) If the Work or designated portion covered by a Certificate of Substantial Completion includes roofing work, the General Contractor's (5-year) Roofing Guarantee, DCM Form C-9, must be executed by the Contractor and attached to the Certificate of Substantial Completion. If the Contract Documents specify any other roofing warranties to be provided by the roofing manufacturer, Subcontractor, or Contractor, they must also be attached to the Certificate of Substantial Completion. The Alabama Division of Construction Management will not sign the Certificate of Substantial Completion in the absence of the roofing guarantees.
- E. The Date of Substantial Completion of the Work, as set in the Certificate of Substantial Completion of the Work or of the last completed portion of the Work, establishes the extent to which the Contractor is liable for Liquidated Damages, if any; however, should the Contractor fail to complete all punch list items within thirty days, or such other time as may be stated in the respective Certificate of Substantial Completion, the Contractor shall bear any expenses, including additional Architectural services and expenses, incurred by the Owner as a result of such failure to complete punch list items in a timely manner.

ARTICLE 33
OCCUPANCY or USE PRIOR to COMPLETION

A. UPON SUBSTANTIAL COMPLETION

Prior to completion of the entire Work, the Owner may occupy or begin utilizing any designated portion of the Work on the agreed Date of Substantial Completion of that portion of the Work.

B. BEFORE SUBSTANTIAL COMPLETION

(1) The Owner shall not occupy or utilize any portion of the Work before Substantial Completion of that portion has been achieved.

(2) The Owner may deliver furniture and equipment and store, or install it in place ready for occupancy and use, in any designated portion of the Work before it is substantially completed under the following conditions:

(a) The Owner's storage or installation of furniture and equipment will not unreasonably disrupt or interfere with the Contractor's completion of the designated portion of the Work.

(b) The Contractor consents to the Owner's planned action (such consent shall not be unreasonably withheld).

(c) The Owner shall be responsible for insurance coverage of the Owner's furniture and equipment, and the Contractor's liability shall not be increased.

(d) The Contractor, Architect, and Owner will jointly inspect and record the condition of the Work in the area before the Owner delivers and stores or installs furniture and equipment; the Owner will equitably compensate the Contractor for making any repairs to the Work that may subsequently be required due to the Owner's delivery and storage or installation of furniture and equipment.

(e) The Owner's delivery and storage or installation of furniture and equipment shall not be deemed an acceptance of any Work not completed in accordance with the requirements of the Contract Documents.

ARTICLE 34
FINAL PAYMENT

A. PREREQUISITES to FINAL PAYMENT

The following conditions are prerequisites to Final Payment becoming due the Contractor:

(1) Full execution of a Certificate of Substantial Completion for the Work, or each designated portion of the Work.

(2) Final Acceptance of the Work.

(3) The Contractor's completion, to the satisfaction of the Architect and Owner, of all documentary requirements of the Contract Documents; such as delivery of "as-built" documents, operating and maintenance manuals, warranties, etc.

(4) Delivery to the Owner of a final Application for Payment, prepared by the Contractor and approved and certified by the Architect. Architect prepares DCM Form B-13: Final Payment Checklist and forwards it to the Owner along with the final Application for Payment.

(5) Completion of an Advertisement for Completion pursuant to Paragraph C below.

(6) Delivery by the Contractor to the Owner through the Architect of DCM Form C-18: Contractor's Affidavit of Payment of Debts and Claims, and a Release of Claims, if any, and

such other documents as may be required by Owner, satisfactory in form to the Owner pursuant to Paragraph D below.

- (7) Consent of Surety to Final Payment, if any, to Contractor. This Consent of Surety is required for projects which have Payment and Performance Bonds.
- (8) Delivery by the Contractor to the Architect and Owner of other documents, if any, required by the Contract Documents as prerequisites to Final Payment.
- (9) See Manual of Procedures Chapter 7, Section L.7 concerning reconciliation of contract time, if any.

B. FINAL ACCEPTANCE of the WORK

“Final Acceptance of the Work” shall be achieved when all “punch list” items recorded with the Certificate(s) of Substantial Completion are accounted for by either: (1) their completion or correction by the Contractor and acceptance by the Architect, Owner, and DCM Project Inspector, or (2) their resolution under Article 18, Deductions for Uncorrected Work.

C. ADVERTISEMENT for COMPLETION

(1) **If the Contract Sum is \$50,000 or less:** The Owner, immediately after being notified by the Architect that all other requirements of the Contract have been completed, shall give public notice of completion of the Contract by having an Advertisement for Completion published one time in a newspaper of general circulation, published in the county in which the Owner is located for one week, and shall require the Contractor to certify under oath that all bills have been paid in full. Final payment may be made at any time after the notice has been posted for one entire week.

(2) **If the Contract Sum is more than \$50,000:** The Contractor, immediately after being notified by the Architect that all other requirements of the Contract have been completed, shall give public notice of completion of the Contract by having an Advertisement for Completion, similar to the sample contained in the Project Manual, published for a period of four successive weeks in some newspaper of general circulation published within the city or county where the Work was performed. Proof of publication of the Advertisement for Completion shall be made by the Contractor to the Architect by affidavit of the publisher, in duplicate, and a printed copy of the Advertisement for Completion published, in duplicate. If no newspaper is published in the county where the work was done, the notice may be given by posting at the Court House for thirty days and proof of same made by Probate Judge or Sheriff and the Contractor. Final payment shall not be due until thirty days after this public notice is completed.

D. RELEASE of CLAIMS

The Release of Claims and other documents referenced in Paragraph A(6) above are as follows:

(1) A release executed by Contractor of all claims and claims of lien against the Owner arising under and by virtue of the Contract, other than such claims of the Contractor, if any, as may have been previously made in writing and as may be specifically excepted by the Contractor from the operation of the release in stated amounts to be set forth therein.

(2) An affidavit under oath, if required, stating that so far as the Contractor has knowledge or information, there are no claims or claims of lien which have been or will be filed by any Subcontractor, Supplier or other party for labor or material for which a claim or claim of lien could be filed.

(3) A release, if required, of all claims and claims of lien made by any Subcontractor, Supplier or other party against the Owner or unpaid Contract funds held by the Owner arising under or related to the Work on the Project; provided, however, that if any Subcontractor, Supplier or others refuse to furnish a release of such claims or claims of lien, the Contractor may furnish a bond executed by Contractor and its Surety to the Owner to provide an unconditional obligation to defend, indemnify and hold harmless the Owner against any loss, cost or expense, including attorney's fees, arising out of or as a result of such claims, or claims of lien, in which event Owner may make Final Payment notwithstanding such claims or claims of lien. If Contractor and Surety fail to fulfill their obligations to Owner under the bond, the Owner shall be entitled to recover damages as a result of such failure, including all costs and reasonable attorney's fees incurred to recover such damages.

E. EFFECT of FINAL PAYMENT

(1) The making of Final Payment shall constitute a waiver of Claims by the Owner except those arising from:

- (a) liens, claims, security interests or encumbrances arising out of the Contract and unsettled;
- (b) failure of the Work to comply with the requirements of the Contract Documents;
- (c) terms of warranties or indemnities required by the Contract Documents, or
- (d) latent defects.

(2) Acceptance of Final Payment by the Contractor shall constitute a waiver of claims by Contractor except those previously made in writing, identified by Contractor as unsettled at the time of final Application for Payment, and specifically excepted from the release provided for in Paragraph D(1), above.

ARTICLE 35
CONTRACTOR'S WARRANTY

A. GENERAL WARRANTY

The Contractor warrants to the Owner and Architect that all materials and equipment furnished under the Contract will be of good quality and new, except such materials as may be expressly provided or allowed in the Contract Documents to be otherwise, and that none of the Work will be Defective Work as defined in Article 1.

B. ONE-YEAR WARRANTY

(1) If, within one year after the date of Substantial Completion of the Work or each designated portion of the Work (or otherwise as agreed upon in a mutually-executed Certificate of Substantial Completion), any of the Work is found to be Defective Work, the Contractor shall promptly upon receipt of written notice from the Owner or Architect, and without expense to either, replace or correct the Defective Work to conform to the requirements of the Contract Documents, and repair all damage to the site, the building and its contents which is the result of Defective Work or its replacement or correction.

(2) The one-year warranty for punch list items shall begin on the Date of Substantial Completion if they are completed or corrected within the time period allowed in the Certificate of Substantial Completion in which they are recorded. The one-year warranty for punch list items that are not

completed or corrected within the time period allowed in the Certificate of Substantial Completion, and other Work performed after Substantial Completion, shall begin on the date of Final Acceptance of the Work. The Contractor's correction of Work pursuant to this warranty does not extend the period of the warranty. The Contractor's one-year warranty does not apply to defects or damages due to improper or insufficient maintenance, improper operation, or wear and tear during normal usage.

(3) Upon recognizing a condition of Defective Work, the Owner shall promptly notify the Contractor of the condition. If the condition is causing damage to the building, its contents, equipment, or site, the Owner shall take reasonable actions to mitigate the damage or its continuation, if practical. If the Contractor fails to proceed promptly to comply with the terms of the warranty, or to provide the Owner with satisfactory written verification that positive action is in process, the Owner may have the Defective Work replaced or corrected and the Contractor and the Contractor's Surety shall be liable for all expense incurred.

(4) **Year-end Inspection(s):** An inspection of the Work, or each separately completed portion thereof, is required near the end of the Contractor's one-year warranty period(s). The inspection must be scheduled with the Owner, Architect and DCM Inspector. The subsequent delivery of the Architect's report of a Year-end Inspection will serve as confirmation that the Contractor was notified of Defective Work found within the warranty period.

(5) The Contractor's warranty of one year is in addition to, and not a limitation of, any other remedy stated herein or available to the Owner under applicable law.

C. GENERAL CONTRACTOR'S ROOFING GUARANTEE

(1) In addition to any other roof related warranties or guarantees that may be specified in the Contract Documents, the roof and associated work shall be guaranteed by the General Contractor against leaks and defects of materials and workmanship for a period of five (5) years, starting on the Date of Substantial Completion of the Project as stated in the Certificate of Substantial Completion. This guarantee for punch list items shall begin on the Date of Substantial Completion if they are completed or corrected within the time period allowed in the Certificate of Substantial Completion in which they are recorded. The guarantee for punch list items that are not completed or corrected within the time period allowed in the Certificate of Substantial Completion shall begin on the date of Final Acceptance of the Work.

(2) The "General Contractor's Roofing Guarantee" (DCM Form C-9), included in the Project Manual, shall be executed in triplicate, signed by the appropriate party and submitted to the Architect for submission with the Certificate of Substantial Completion to the Owner and the Division of Construction Management.

(3) This guarantee does not include costs which might be incurred by the General Contractor in making visits to the site requested by the Owner regarding roof problems that are due to lack of proper maintenance (keeping roof drains and/or gutters clear of debris that cause a stoppage of drainage which results in water ponding, overflowing of flashing, etc.), or damages caused by vandalism or misuse of roof areas. Should the contractor be required to return to the job to correct problems of this nature that are determined not to be related to faulty workmanship and materials in the installation of the roof, payment for actions taken by the Contractor in response to such request will be the responsibility of the Owner. A detailed written report shall be made by the General Contractor on each of these 'Service Calls' with copies to the Architect, Owner and Division of

Construction Management.

D. SPECIAL WARRANTIES

(1) The Contractor shall deliver to the Owner through the Architect all special or extended warranties required by the Contract Documents from the Contractor, Subcontractors, and suppliers.

(2) The Contractor and the Contractor's Surety shall be liable to the Owner for such special warranties during the Contractor's one-year warranty; thereafter, the Contractor's obligations relative to such special warranties shall be to provide reasonable assistance to the Owner in their enforcement.

E. ASSUMPTION of GUARANTEES of OTHERS

If the Contractor disturbs, alters, or damages any work guaranteed under a separate contract, thereby voiding the guarantee of that work, the Contractor shall restore the work to a condition satisfactory to the Owner and shall also guarantee it to the same extent that it was guaranteed under the separate contract.

**ARTICLE 36
INDEMNIFICATION AGREEMENT**

To the fullest extent permitted by law, the Contractor shall defend, indemnify, and hold harmless the Owner, Architect, Architect's consultants, Alabama Division of Construction Management, State Department of Education (if applicable), and their agents, employees, and consultants (hereinafter collectively referred to as the "Indemnitees") from and against all claims, damages, losses and expenses, including but not limited to attorneys' fees, arising out of, related to, or resulting from performance of the Work, provided that such claim, damage, loss or expense is attributable to bodily injury, sickness, disease or death, or to injury to or destruction of tangible property, including loss of use resulting therefrom, and is caused in whole or in part by negligent acts or omissions of the Contractor, a Subcontractor, anyone directly or indirectly employed by them, or anyone for whose acts they may be liable, regardless of whether such claim, damage, loss or expense is caused in part, or is alleged but not legally established to have been caused in whole or in part by the negligence or other fault of a party indemnified hereunder.

- A. This indemnification shall extend to all claims, damages, losses and expenses for injury or damage to adjacent or neighboring property, or persons injured thereon, that arise out of, relate to, or result from performance of the Work.
- B. This indemnification does not extend to the liability of the Architect, or the Architect's Consultants, agents, or employees, arising out of (1) the preparation or approval of maps, shop drawings, opinions, reports, surveys, field orders, Change Orders, drawings or specifications, or (2) the giving of or the failure to give directions or instructions, provided such giving or failure to give instructions is the primary cause of the injury or damage.
- C. This indemnification does not apply to the extent of the sole negligence of the Indemnitees.

ARTICLE 37
CONTRACTOR'S and SUBCONTRACTORS' INSURANCE

(Provide entire Article 37 to Contractor's insurance representative.)

A. GENERAL

(1) RESPONSIBILITY. The Contractor shall be responsible to the Owner from the time of the signing of the Construction Contract or from the beginning of the first work, whichever shall be earlier, for all injury or damage of any kind resulting from any negligent act or omission or breach, failure or other default regarding the work by the Contractor, a Subcontractor, anyone directly or indirectly employed by them or anyone for whose acts they may be liable, regardless of who may be the owner of the property.

(2) INSURANCE PROVIDERS. Each of the insurance coverages required below shall be issued by an insurer licensed by the Insurance Commissioner to transact the business of insurance in the State of Alabama for the applicable line of insurance, and such insurer (or, for qualified self-insureds or group self-insureds, a specific excess insurer providing statutory limits) must have a Best Policyholders Rating of "A-" or better and a financial size rating of Class V or larger.

(3) NOTIFICATION ENDORSEMENT. Each policy shall be endorsed to provide that the insurance company agrees that the policy shall not be canceled, changed, allowed to lapse or allowed to expire for any reason until thirty days after the Owner has received written notice by certified mail as evidenced by return receipt or until such time as other insurance coverage providing protection equal to protection called for in the Contract Documents shall have been received, accepted and acknowledged by the Owner. Such notice shall be valid only as to the Project as shall have been designated by Project Name and Number in said notice.

(4) INSURANCE CERTIFICATES. The Contractor shall procure the insurance coverages identified below, or as otherwise required in the Contract Documents, at the Contractor's own expense, and to evidence that such insurance coverages are in effect, the Contractor shall furnish the Owner an insurance certificate(s) acceptable to the Owner and listing the Owner as the certificate holder. The insurance certificate(s) must be delivered to the Owner with the Construction Contract and Bonds for final approval and execution of the Construction Contract. The insurance certificate must provide the following:

- (a) Name and address of authorized agent of the insurance company
- (b) Name and address of insured
- (c) Name of insurance company or companies
- (d) Description of policies
- (e) Policy Number(s)
- (f) Policy Period(s)
- (g) Limits of liability
- (h) Name and address of Owner as certificate holder
- (i) Project Name and Number, if any
- (j) Signature of authorized agent of the insurance company
- (k) Telephone number of authorized agent of the insurance company
- (l) Mandatory thirty day notice of cancellation / non-renewal / change

(5) MAXIMUM DEDUCTIBLE. Self-insured retention, except for qualified self-insurers or

group self-insurers, in any policy shall not exceed \$25,000.00.

B. INSURANCE COVERAGES

Unless otherwise provided in the Contract Documents, the Contractor shall purchase the types of insurance coverages with liability limits not less than as follows:

(1) WORKERS' COMPENSATION and EMPLOYER'S LIABILITY INSURANCE

(a) Workers' Compensation coverage shall be provided in accordance with the statutory coverage required in Alabama. A group insurer must submit a certificate of authority from the Alabama Department of Industrial Relations approving the group insurance plan. A self-insurer must submit a certificate from the Alabama Department of Industrial Relations stating the Contractor qualifies to pay its own workers' compensation claims.

(b) Employer's Liability Insurance limits shall be at least:

- .1 Bodily Injury by Accident - \$1,000,000 each accident
- .2 Bodily Injury by Disease - \$1,000,000 each employee

(2) COMMERCIAL GENERAL LIABILITY INSURANCE

(a) Commercial General Liability Insurance, written on an ISO Occurrence Form (current edition as of the date of Advertisement for Bids) or equivalent, shall include, but need not be limited to, coverage for bodily injury and property damage arising from premises and operations liability, products and completed operations liability, blasting and explosion, collapse of structures, underground damage, personal injury liability and contractual liability. The Commercial General Liability Insurance shall provide at minimum the following limits:

<u>Coverage</u>	<u>Limit</u>
.1 General Aggregate	\$ 2,000,000.00 per Project
.2 Products, Completed Operations Aggregate	\$ 2,000,000.00 per Project
.3 Personal and Advertising Injury	\$ 1,000,000.00 per Occurrence
.4 Each Occurrence	\$ 1,000,000.00

(b) Additional Requirements for Commercial General Liability Insurance:

- .1 The policy shall name the Owner, Architect, Alabama Division of Construction Management, State Department of Education (if applicable), and their agents, consultants and employees as additional insureds, state that this coverage shall be primary insurance for the additional insureds; and contain no exclusions of the additional insureds relative to job accidents.
- .2 The policy must include separate per project aggregate limits.

(3) COMMERCIAL BUSINESS AUTOMOBILE LIABILITY INSURANCE

(a) Commercial Business Automobile Liability Insurance which shall include coverage for bodily injury and property damage arising from the operation of any owned, non-owned or hired automobile. The Commercial Business Automobile Liability Insurance Policy shall provide not less than \$1,000,000 Combined Single Limits for each occurrence.

(b) The policy shall name the Owner, Architect, Alabama Division of Construction Management, State Department of Education (if applicable), and their agents, consultants, and employees as additional insureds.

(4) COMMERCIAL UMBRELLA LIABILITY INSURANCE

(a) Commercial Umbrella Liability Insurance to provide excess coverage above the

Commercial General Liability, Commercial Business Automobile Liability and the Workers' Compensation and Employer's Liability to satisfy the minimum limits set forth herein.

(b) Minimum Combined Primary Commercial General Liability and Commercial/Excess Umbrella Limits of:

- .1 \$ 5,000,000 per Occurrence
- .2 \$ 5,000,000 Aggregate

(c) Additional Requirements for Commercial Umbrella Liability Insurance:

- .1 The policy shall name the Owner, Architect, Alabama Division of Construction Management, State Department of Education (if applicable), and their agents, consultants, and employees as additional insureds.
- .2 The policy must be on an "occurrence" basis.

(5) BUILDER'S RISK INSURANCE

(a) The Builder's Risk Policy shall be made payable to the Owner and Contractor, as their interests may appear. The policy amount shall be equal to 100% of the Contract Sum, written on a Causes of Loss - Special Form (current edition as of the date of Advertisement for Bids), or its equivalent. All deductibles shall be the sole responsibility of the Contractor.

(b) The policy shall be endorsed as follows:

"The following may occur without diminishing, changing, altering or otherwise affecting the coverage and protection afforded the insured under this policy:

- (i) Furniture and equipment may be delivered to the insured premises and installed in place ready for use; or
- (ii) Partial or complete occupancy by Owner; or
- (iii) Performance of work in connection with construction operations insured by the Owner, by agents or lessees or other contractors of the Owner, or by contractors of the lessee of the Owner."

C. SUBCONTRACTORS' INSURANCE

(1) **WORKERS' COMPENSATION and EMPLOYER'S LIABILITY INSURANCE.** The Contractor shall require each Subcontractor to obtain and maintain Workers' Compensation and Employer's Liability Insurance coverages as described in preceding Paragraph B, or to be covered by the Contractor's Workers' Compensation and Employer's Liability Insurance while performing Work under the Contract.

(2) **LIABILITY INSURANCE.** The Contractor shall require each Subcontractor to obtain and maintain adequate General Liability, Automobile Liability, and Umbrella Liability Insurance coverages similar to those described in preceding Paragraph B. Such coverage shall be in effect at all times that a Subcontractor is performing Work under the Contract.

(3) **ENFORCEMENT RESPONSIBILITY.** The Contractor shall have responsibility to enforce its Subcontractors' compliance with these or similar insurance requirements; however, the Contractor shall, upon request, provide the Architect or Owner acceptable evidence of insurance for any Subcontractor.

D. TERMINATION of OBLIGATION to INSURE

Unless otherwise expressly provided in the Contract Documents, the obligation to insure as provided herein shall continue as follows:

(1) BUILDER'S RISK INSURANCE. The obligation to insure under Subparagraph B(5) shall remain in effect until the Date of Substantial Completion as shall be established in the Certificate of Substantial Completion. In the event that multiple Certificates of Substantial Completion covering designated portions of the Work are issued, Builder's Risk coverage shall remain in effect until the Date of Substantial Completion as shall be established in the last issued Certificate of Substantial Completion. However, in the case that the Work involves separate buildings, Builder's Risk coverage of each separate building may terminate on the Date of Substantial Completion as established in the Certificate of Substantial Completion issued for each building.

(2) PRODUCTS and COMPLETED OPERATIONS. The obligation to carry Products and Completed Operations coverage specified under Subparagraph B(2) shall remain in effect for two years after the Date(s) of Substantial Completion.

(3) ALL OTHER INSURANCE. The obligation to carry other insurance coverages specified under Subparagraphs B(1) through B(4) and Paragraph C shall remain in effect after the Date(s) of Substantial Completion until such time as all Work required by the Contract Documents is completed. Equal or similar insurance coverages shall remain in effect if, after completion of the Work, the Contractor, a Subcontractor, anyone directly or indirectly employed by them or anyone for whose acts they may be liable, returns to the Project to perform warranty or maintenance work pursuant to the terms of the Contract Documents.

E. WAIVERS of SUBROGATION

The Owner and Contractor waive all rights against (1) each other and any of their subcontractors, sub-subcontractors, agents and employees, each of the other, and (2) the Architect, Architect's consultants, separate contractors performing construction or operations related to the Project, if any, and any of their subcontractors, sub-subcontractors, agents and employees, for damages caused by fire or other causes of loss. But said waiver shall apply only to the extent the loss or damage is covered by builder's risk insurance applicable to the Work or to other property located within or adjacent to the Project, except such rights as they may have to proceeds of such insurance held by the Owner or Contractor as fiduciary. The Owner or Contractor, as appropriate, shall require of the Architect, Architect's consultants, separate contractors, if any, and the subcontractor, sub-subcontractors, suppliers, agents and employees of any of them, by appropriate agreements, written where legally required for validity, similar waivers each in favor of other parties enumerated herein. The Policies shall provide such waivers of subrogation by endorsement or otherwise. A waiver of subrogation shall be effective as to the person or entity even though that person or entity would otherwise have a duty of indemnification, contractual or otherwise, did not pay the insurance premium directly or indirectly, and whether or not the person or entity had an insurable interest in the property damaged. The waivers provided for in this paragraph shall not be applicable to loss or damage that occurs after final acceptance of the Work.

ARTICLE 38
PERFORMANCE and PAYMENT BONDS

A. GENERAL

Upon signing and returning the Construction Contract to the Owner for final approval and execution, the Contractor shall, at the Contractor's expense, furnish to the Owner a Performance Bond and a Payment Bond (P&P Bonds), DCM Forms C-6 and C-7 as contained in the Project

Manual, each in a penal sum equal to 100% of the Contract Sum. Each bond shall be on the form contained in the Project Manual, shall be executed by a surety company (Surety) acceptable to the Owner and duly authorized and qualified to make such bonds in the State of Alabama in the required amount. There shall be six original P&P Bonds submitted with original signatures for each of the six contracts required. The P&P bonds must be signed either on the same day or after the construction contract date. Each P&P Bond shall have attached thereto an original power of attorney (POA) of the signing official. The POA signature date must be the same day as the P&P Bond's signature date. All signatures must be present.

The provisions of this Article are not applicable to this Contract if the Contract Sum is less than \$50,000, unless bonds are required for this Contract in the Supplemental General Conditions.

B. PERFORMANCE BOND

Through the Performance Bond, the Surety's obligation to the Owner shall be to assure the prompt and faithful performance of the Contract and Contract Change Orders. The Penal Sum shall remain equal to the Contract Sum as the Contract Sum is adjusted by Contract Change Orders. In case of default on the part of the Contractor, the Surety shall take charge of and complete the Work in accordance with the terms of the Performance Bond. Any reasonable expenses incurred by the Owner as a result of default on the part of the Contractor, including architectural, engineering, administrative, and legal services, shall be recoverable under the Performance Bond.

C. PAYMENT BOND

Through the Payment Bond the Surety's obligation to the Owner shall be to guarantee that the Contractor and its Subcontractors shall promptly make payment to all persons supplying labor, materials, or supplies for, or in, the prosecution of the Work, including the payment of reasonable attorneys fees incurred by successful claimants or plaintiffs in civil actions on the Bond. Any person or entity indicating that they have a claim of nonpayment under the Bond shall, upon written request, be promptly furnished a certified copy of the Bond and Construction Contract by the Contractor, Architect, Owner, or Alabama Division of Construction Management, whomever is recipient of the request.

D. CHANGE ORDERS

The Penal Sum shall remain equal to the Contract Sum as the Contract Sum is adjusted by Contract Change Orders. All Contract Change Orders involving an increase in the Contract Sum will require consent of Surety by endorsement of the Contract Change Order form. The Surety waives notification of any Contract Change Orders involving only extension of the Contract Time.

E. EXPIRATION

The obligations of the Contractor's performance bond surety shall be coextensive with the contractor's performance obligations under the Contract Documents; provided, however, that the surety's obligation shall expire at the end of the one-year warranty period(s) of Article 35.

ARTICLE 39
ASSIGNMENT

The Contractor shall not assign the Contract or sublet it as a whole nor assign any moneys due or to

become due to the Contractor thereunder without the previous written consent of the Owner (and of the Surety, in the case of a bonded Construction Contract). As prescribed by the Public Works Law, the Contract shall in no event be assigned to an unsuccessful bidder for the Contract whose bid was rejected because the bidder was not a responsible or responsive bidder.

ARTICLE 40
CONSTRUCTION by OWNER or SEPARATE CONTRACTORS

A. OWNER'S RESERVATION of RIGHT

(1) The Owner reserves the right to self-perform, or to award separate contracts for, other portions of the Project and other Project related construction and operations on the site. The contractual conditions of such separate contracts shall be substantially similar to those of this Contract, including insurance requirements and the provisions of this Article. If the Contractor considers such actions to involve delay or additional cost under this Contract, notifications and assertion of claims shall be as provided in Article 20 and Article 23.

(2) When separate contracts are awarded, the term "Contractor" in the separate Contract Documents shall mean the Contractor who executes the respective Construction Contract.

B. COORDINATION

Unless otherwise provided in the Contract Documents, the Owner shall be responsible for coordinating the activities of the Owner's forces and separate contractors with the Work of the Contractor. The Contractor shall cooperate with the Owner and separate contractors, shall participate in reviewing and comparing their construction schedules relative to that of the Contractor when directed to do so, and shall make and adhere to any revisions to the construction schedule resulting from a joint review and mutual agreement.

C. CONDITIONS APPLICABLE to WORK PERFORMED by OWNER

Unless otherwise provided in the Contract Documents, when the Owner self-performs construction or operations related to the Project, the Owner shall be subject to the same obligations to Contractor as Contractor would have to a separate contractor under the provision of this Article 40.

D. MUTUAL RESPONSIBILITY

(1) The Contractor shall reasonably accommodate the required introduction and storage of materials and equipment and performance of activities by the Owner and separate contractors and shall connect and coordinate the Contractor's Work with theirs as required by the Contract Documents.

(2) By proceeding with an element or portion of the Work that is applied to or performed on construction by the Owner or a separate contractor, or which relies upon their operations, the Contractor accepts the condition of such construction or operations as being suitable for the Contractor's Work, except for conditions that are not reasonably discoverable by the Contractor. If the Contractor discovers any condition in such construction or operations that is not suitable for the proper performance of the Work, the Contractor shall not proceed, but shall instead promptly notify

the Architect in writing of the condition discovered.

(3) The Contractor shall reimburse the Owner for any costs incurred by a separate contractor and payable by the Owner because of acts or omissions of the Contractor. Likewise, the Owner shall be responsible to the Contractor for any costs incurred by the Contractor because of the acts or omissions of a separate contractor.

(4) The Contractor shall not cut or otherwise alter construction by the Owner or a separate contractor without the written consent of the Owner and separate contractor; such consent shall not be unreasonably withheld. Likewise, the Contractor shall not unreasonably withhold its consent allowing the Owner or a separate contractor to cut or otherwise alter the Work.

(5) The Contractor shall promptly remedy any damage caused by the Contractor to the construction or property of the Owner or separate contractors.

ARTICLE 41 **SUBCONTRACTS**

A. AWARD of SUBCONTRACTS and OTHER CONTRACTS for PORTIONS of the WORK

(1) Unless otherwise provided in the Contract Documents, when delivering the executed Construction Contract, bonds, and evidence of insurance to the Architect, the Contractor shall also submit a listing of Subcontractors proposed for each principal portion of the Work and fabricators or suppliers proposed for furnishing materials or equipment fabricated to the design of the Contract Documents. This listing shall be in addition to any naming of Subcontractors, fabricators, or suppliers that may have been required in the bid process. The Architect will promptly reply to the Contractor in writing stating whether or not the Owner, after due investigation, has reasonable objection to any Subcontractor, fabricator, or supplier proposed by the Contractor. The issuance of the Notice to Proceed in the absence of such objection by the Owner shall constitute notice that no reasonable objection to them is made.

(2) The Contractor shall not contract with a proposed Subcontractor, fabricator, or supplier to whom the Owner has made reasonable and timely objection. Except in accordance with prequalification procedures as may be contained in the Contract Documents, through specified qualifications, or on the grounds of reasonable objection, the Owner may not restrict the Contractor's selection of Subcontractors, fabricators, or suppliers.

(3) Upon the Owner's reasonable objection to a proposed Subcontractor, fabricator, or supplier, the Contractor shall promptly propose another to whom the Owner has no reasonable objection. If the proposed Subcontractor, fabricator, or supplier to whom the Owner made reasonable objection was reasonably capable of performing the Work, the Contract Sum and Contract Time shall be equitably adjusted by Contract Change Order for any resulting difference if the Contractor has acted promptly and responsively in this procedure.

(4) The Contractor shall not change previously selected Subcontractors, fabricators, or suppliers without notifying the Architect and Owner in writing of proposed substitute Subcontractors, fabricators, or suppliers. If the Owner does not make a reasonable objection to a proposed substitute within three working days, the substitute shall be deemed approved.

B. SUBCONTRACTUAL RELATIONS

(1) The Contractor agrees to bind every Subcontractor and material supplier (and require every Subcontractor to so bind its subcontractors and material suppliers) to all the provisions of the Contract Documents as they apply to the Subcontractor's and material supplier's portion of the Work.

(2) Nothing contained in the Contract Documents shall be construed as creating any contractual relationship between any Subcontractor and the Owner, nor to create a duty of the Architect, Owner, or Director to resolve disputes between or among the Contractor or its Subcontractors and suppliers or any other duty to such Subcontractors or suppliers.

ARTICLE 42 **ARCHITECT'S STATUS**

- A. The Architect is an independent contractor performing, with respect to this Contract, pursuant to an agreement executed between the Owner and the Architect. The Architect has prepared the Drawings and Specifications and assembled the Contract Document and is, therefore, charged with their interpretation and clarification as described in the Contract Documents. As a representative of the Owner, the Architect will endeavor to guard the Owner against variances from the requirements of the Contract Documents by the Contractor. On behalf of the Owner, the Architect will administer the Contract as described in the Contract Documents during construction and the Contractor's one-year warranty.
- B. So as to maintain continuity in administration of the Contract and performance of the Work, and to facilitate complete documentation of the project record, all communications between the Contractor and Owner regarding matters of or related to the Contract shall be directed through the Architect, unless direct communication is otherwise required to provide a legal notification. Unless otherwise authorized by the Architect, communications by and with the Architect's consultants shall be through the Architect. Unless otherwise authorized by the Contractor, communications by and with Subcontractors and material suppliers shall be through the Contractor.
- C. **ARCHITECT'S AUTHORITY**

Subject to other provisions of the Contract Documents, the following summarizes some of the authority vested in the Architect by the Owner with respect to the Construction Contract and as further described or conditioned in other Articles of these General Conditions of the Contract.

- (1) **The Architect is authorized to:**
- (a) approve "minor" deviations as defined in Article 9, Submittals,
 - (b) make "minor" changes in the Work as defined in Article 19, Changes in the Work,
 - (c) reject or require the correction of Defective Work,
 - (d) require the Contractor to stop the performance of Defective Work,
 - (e) adjust an Application for Payment by the Contractor pursuant to Article 30, Certification and Approval of payments, and
 - (f) issue Notices to Cure pursuant to Article 27.
- (2) **The Architect is not authorized to:**
- (a) revoke, alter, relax, or waive any requirements of the Contract Documents (other than "minor" deviations and changes) without concurrence of the Owner,

- (b) finally approve or accept any portion of the Work without concurrence of the Owner,
- (c) issue instructions contrary to the Contract Documents,
- (d) issue Notice of Termination or otherwise terminate the Contract, or
- (e) require the Contractor to stop the Work except only to avoid the performance of Defective Work.

D. LIMITATIONS of RESPONSIBILITIES

- (1) The Architect shall not be responsible to Contractors or to others for supervising or coordinating the performance of the Work or for the Construction Methods or safety of the Work, unless the Contract Documents give other specific instructions concerning these matters.
- (2) The Architect will not be responsible to the Contractor (nor the Owner) for the Contractor's failure to perform the Work in accordance with the requirements of the Contract Documents or for acts or omissions of the Contractor, a Subcontractor, or anyone for whose acts they may be liable. However, the Architect will report to the Owner and Contractor any Defective Work recognized by the Architect.
- (3) The Architect will endeavor to secure faithful performance by Owner and Contractor, and the Architect will not show partiality to either or be liable to either for results of interpretations or decisions rendered in good faith.
- (4) The Contractor's remedies for additional time or expense arising out of or related to this Contract, or the breach thereof, shall be solely as provided for in the Contract Documents. The Contractor shall have no claim or cause of action against the Owner, Architect, or its consultants for any actions or failures to act, whether such claim may be in contract, tort, strict liability, or otherwise, it being the agreement of the parties that the Contractor shall make no claim against the Owner or any agents of the Owner, including the Architect or its consultants, except as may be provided for claims or disputes submitted in accordance with Article 24. The Architect and Architect's consultants shall be considered third party beneficiaries of this provision of the Contract and entitled to enforce same.

E. ARCHITECT'S DECISIONS

Decisions by the Architect shall be in writing. The Architect's decisions on matters relating to aesthetic effect will be final and binding if consistent with the intent expressed in the Contract Documents. The Architect's decisions regarding disputes arising between the Contractor and Owner shall be advisory.

**ARTICLE 43
CASH ALLOWANCES**

- A. All allowances stated in the Contract Documents shall be included in the Contract Sum. Items covered by allowances shall be supplied by the Contractor as directed by the Architect or Owner and the Contractor shall afford the Owner the economy of obtaining competitive pricing from responsible bidders for allowance items unless other purchasing procedures are specified in the Contract Documents.
- B. Unless otherwise provided in the Contract Documents:
 - (1) allowances shall cover the cost to the Contractor of materials and equipment delivered to the

- Project site and all applicable taxes, less applicable trade discounts;
- (2) the Contractor's costs for unloading, storing, protecting, and handling at the site, labor, installation, overhead, profit and other expenses related to materials or equipment covered by an allowance shall be included in the Contract Sum but not in the allowances;
 - (3) if required, the Contract Sum shall be adjusted by Change Order to reflect the actual costs of an allowance.
- C. Any selections of materials or equipment required of the Architect or Owner under an allowance shall be made in sufficient time to avoid delay of the Work.

ARTICLE 44
PERMITS, LAWS, and REGULATIONS

A. PERMITS, FEES AND NOTICES

- (1) Unless otherwise provided in the Contract Documents, the Contractor shall secure and pay for the building permit and other permits and governmental fees, licenses, and inspections necessary for proper execution and completion of the Work which are customarily secured after award of the Construction Contract and which are in effect on the date of receipt of bids.
- (2) The Contractor shall comply with and give notices required by all laws, ordinances, rules, regulations, and lawful orders of public authorities applicable to performance of the Work.

B. TAXES

Unless stated otherwise in the Contract Documents, materials incorporated into the Work are exempt from sales and use tax pursuant to Section 40-9-33, Code of Alabama, 1975 as amended. The Owner, Contractor and its subcontractors shall be responsible for complying with rules and regulations of the Sales, Use, & Business Tax Division of the Alabama Department of Revenue regarding certificates and other qualifications necessary to claim such exemption when making qualifying purchases from vendors. The Contractor shall pay all applicable taxes that are not covered by the exemption of Section 40-9-33 and which are imposed as of the date of receipt of bids, including those imposed as of the date of receipt of bids but scheduled to go into effect after that date.

C. COMPENSATION for INCREASES

The Contractor shall be compensated for additional costs incurred because of increases in tax rates imposed after the date of receipt of bids.

D. ALABAMA IMMIGRATION LAW

Per ACT 2011-535 as codified in Title 31, Chapter 13 of the Code of Alabama, 1975, as amended:

The contracting parties affirm, for the duration of the agreement, that they will not violate federal immigration law or knowingly employ, hire for employment, or continue to employ an unauthorized alien within the State of Alabama. Furthermore, a contracting party found to be in violation of this provision shall be deemed in breach of the agreement and shall be responsible for

all damages resulting therefrom.

E. ALABAMA BOYCOTT LAW

Per Act 2016-312 as codified in Title 41, Chapter 16, Article 1, of the Code of Alabama, 1975, as amended:

The contracting parties affirm, for the duration of the agreement, that they are not currently engaged in, and will not engage in, the boycott of a person or an entity based in or doing business with a jurisdiction with which this state can enjoy open trade.

F. ACCOUNTING OF SALES TAX EXEMPT PROJECTS

Per Act 2013-205 as codified in Title 40, Chapter 9, Article 1, of the Code of Alabama, 1975, as amended:

In bidding the work on a tax exempt project, the bid form shall provide an accounting for the tax savings.

ARTICLE 45
ROYALTIES, PATENTS, and COPYRIGHTS

The Contractor shall pay all royalties and license fees. The Contractor shall defend, indemnify and hold harmless the Owner, Architect, Architect's consultants, Alabama Division of Construction Management, State Department of Education (if applicable), and their agents, employees, and consultants from and against all claims, damages, losses and expenses, including but not limited to attorney's fees, arising out of, related to, or resulting from all suits or claims for infringement of any patent rights or copyrights arising out of the inclusion of any patented or copyrighted materials, methods, or systems selected by the Contractor and used during the execution of or incorporated into the Work. This indemnification does not apply to any suits or claims of infringement of any patent rights or copyrights arising out of any patented or copyrighted materials, methods, or systems specified in the Contract Documents. However, if the Contractor has information that a specified material, method, or system is or may constitute an infringement of a patent or copyright, the Contractor shall be responsible for any resulting loss unless such information is promptly furnished to the Architect.

ARTICLE 46
USE of the SITE

- A. The Contractor shall confine its operations at the Project site to areas permitted by the Owner and by law, ordinances, permits and the Contract Documents and shall not unreasonably encumber the site with materials, equipment, employees' vehicles, or debris. The Contractor's operations at the site shall be restricted to the sole purpose of constructing the Work, use of the site as a staging, assembly, or storage area for other business which the Contractor may undertake shall not be permitted.
- B. Unless otherwise provided in the Contract Documents, temporary facilities, such as storage sheds, shops, and offices may be erected on the Project site with the approval of the Architect and Owner.

Such temporary buildings and/or utilities shall remain the property of the Contractor, and be removed at the Contractor's expense upon completion of the Work, unless the Owner authorizes their abandonment without removal.

ARTICLE 47
CUTTING and PATCHING

- A. The Contractor shall be responsible for all cutting, fitting, or patching that may be required to execute the Work to the results indicated in the Contract Documents or to make its parts fit together properly.
- B. Any cutting, patching, or excavation by the Contractor shall be supervised and performed in a manner that will not endanger persons nor damage or endanger the Work or any fully or partially completed construction of the Owner or separate contractors.

ARTICLE 48
IN-PROGRESS and FINAL CLEANUP

A. IN-PROGRESS CLEAN-UP

- (1) The Contractor shall at all times during the progress of the Work keep the premises and surrounding area free from rubbish, scrap materials and debris resulting from the Work. Trash and combustible materials shall not be allowed to accumulate inside buildings or elsewhere on the premises. At no time shall any rubbish be thrown from window openings. Burning of trash and debris on site is not permitted.
- (2) The Contractor shall make provisions to minimize and confine dust and debris resulting from construction activities.

B. FINAL CLEAN-UP

- (1) Before Substantial Completion or Final Acceptance is achieved, the Contractor shall have removed from the Owner's property all construction equipment, tools, and machinery; temporary structures and/or utilities including the foundations thereof (except such as the Owner permits in writing to remain); rubbish, debris, and waste materials; and all surplus materials, leaving the site clean and true to line and grade, and the Work in a safe and clean condition, ready for use and operation.
- (2) In addition to the above, and unless otherwise provided in the Contract Documents, the Contractor shall be responsible for the following special cleaning for all trades as the Work is completed:
 - (a) **Cleaning of all painted, enameled, stained, or baked enamel work:** Removal of all marks, stains, finger prints and splatters from such surfaces.
 - (b) **Cleaning of all glass:** Cleaning and removing of all stickers, labels, stains, and paint from all glass, and the washing and polishing of same on interior and exterior.
 - (c) **Cleaning or polishing of all hardware:** Cleaning and polishing of all hardware.
 - (d) **Cleaning all tile, floor finish of all kinds:** Removal of all splatters, stains, paint, dirt,

and dust, the washing and polishing of all floors as recommended by the manufacturer or required by the Architect.

(e) Cleaning of all manufactured articles, materials, fixtures, appliances, and equipment: Removal of all stickers, rust stains, labels, and temporary covers, and cleaning and conditioning of all manufactured articles, material, fixtures, appliances, and electrical, heating, and air conditioning equipment as recommended or directed by the manufacturers, unless otherwise required by the Architect; blowing out or flushing out of all foreign matter from all equipment, piping, tanks, pumps, fans, motors, devices, switches, panels, fixtures, boilers, sanitizing potable water systems; and freeing identification plates on all equipment of excess paint and the polishing thereof.

C. OWNER'S RIGHT to CLEAN-UP

If the Contractor fails to comply with these clean-up requirements and then fails to comply with a written directive by the Architect to clean-up the premises within a specified time, the Architect or Owner may implement appropriate clean-up measures and the cost thereof shall be deducted from any amounts due or to become due the Contractor.

ARTICLE 49
LIQUIDATED DAMAGES

- A.** Time is the essence of the Contract. Any delay in the completion of the Work required by the Contract Documents may cause inconvenience to the public and loss and damage to the Owner including but not limited to interest and additional administrative, architectural, inspection and supervision charges. By executing the Construction Contract, the Contractor agrees that the Contract Time is sufficient for the achievement of Substantial Completion.
- B.** The Contract Documents may provide in the Construction Contract or elsewhere for a certain dollar amount for which the Contractor and its Surety (if any) will be liable to the Owner as liquidated damages for each calendar day after expiration of the Contract Time that the Contractor fails to achieve Substantial Completion of the Work. If such daily liquidated damages are provided for, Owner and Contractor, and its Surety, agree that such amount is reasonable and agree to be bound thereby.
- C.** If a daily liquidated damage amount is not otherwise provided for in the Contract Documents, a time charge equal to six percent interest per annum on the total Contract Sum may be made against the Contractor for the entire period after expiration of the Contract Time that the Contractor fails to achieve Substantial Completion of the Work.
- D.** The amount of liquidated damages due under either paragraph B or C, above, may be deducted by the Owner from the moneys otherwise due the Contractor in the Final Payment, not as a penalty, but as liquidated damages sustained, or the amount may be recovered from Contractor or its Surety. If part of the Work is substantially completed within the Contract Time and part is not, the stated charge for liquidated damages shall be equitably prorated to that portion of the Work that the Contractor fails to substantially complete within the Contract Time. It is mutually understood and agreed between the parties hereto that such amount is reasonable as liquidated damages.

ARTICLE 50
USE of FOREIGN MATERIALS

- A. In the performance of the Work the Contractor agrees to use materials, supplies, and products manufactured, mined, processed or otherwise produced in the United States or its territories, if same are available at reasonable and competitive prices and are not contrary to any sole source specification implemented under the Public Works Law.
- B. In the performance of the Work the Contractor agrees to use steel produced in the United States if the Contract Documents require the use of steel and do not limit its supply to a sole source pursuant to the Public Works Law. If the Owner decides that the procurement of domestic steel products becomes impractical as a result of national emergency, national strike, or other cause, the Owner shall waive this restriction.
- C. If domestic steel or other domestic materials, supplies, and products are not used in accordance with preceding Paragraphs A and B, the Contract Sum shall be reduced by an amount equal to any savings or benefits realized by the Contractor.
- D. This Article applies only to Public Works projects financed entirely by the State of Alabama or any political subdivision of the state.

ARTICLE 51
PROJECT SIGN

- A. Fully locally-funded State Agency and Public Higher Education projects: DCM Form C-15: Detail of Project Sign must be included in the project manual regardless of expected bid amount. If the awarded contract sum is \$100,000.00 or more, Contractor shall furnish and erect a project sign. Other conditions besides the contract sum may warrant waiver of this requirement, but only with approval of the Technical Staff.
- B. Fully locally-funded K-12 school projects: Project sign is not required unless requested by Owner; if project sign is requested by Owner, include DCM Form C-15: Detail of Project Sign in the project manual.
- C. Partially or fully PSCA-funded projects: DCM Form C-15: Detail of Project Sign must be included in the project manual. Contractor shall furnish and erect a project sign for all PSCA-funded projects, regardless of the contract sum. "Alabama Public School and College Authority" as well as the local owner entity must be included as awarding authorities on the project sign of all PSCA-funded projects.

When required per the above conditions, the project sign shall be erected in a prominent location selected by the Architect and Owner and shall be maintained in good condition until completion of Work. If the Contract involves Work on multiple sites, only one project sign is required, which shall be erected on one of the sites in a location selected by the Architect and Owner. Slogan: The title of the current PSCA Act should be placed on the project sign of all PSCA-funded projects, otherwise the Awarding Authority/Owner's slogan, if any, should be used. If the Awarding Authority/Owner of a fully locally-funded project does not have a slogan, the project sign does not require a slogan.

END of
GENERAL CONDITIONS of the CONTRACT

ARTICLE 37
CONTRACTOR'S and SUBCONTRACTORS' INSURANCE

(Provide entire Article 37 to Contractor's insurance representative.)

A. GENERAL

(1) RESPONSIBILITY. The Contractor shall be responsible to the Owner from the time of the signing of the Construction Contract or from the beginning of the first work, whichever shall be earlier, for all injury or damage of any kind resulting from any negligent act or omission or breach, failure or other default regarding the work by the Contractor, a Subcontractor, anyone directly or indirectly employed by them or anyone for whose acts they may be liable, regardless of who may be the owner of the property.

(2) INSURANCE PROVIDERS. Each of the insurance coverages required below shall be issued by an insurer licensed by the Insurance Commissioner to transact the business of insurance in the State of Alabama for the applicable line of insurance, and such insurer (or, for qualified self-insureds or group self-insureds, a specific excess insurer providing statutory limits) must have a Best Policyholders Rating of "A-" or better and a financial size rating of Class V or larger.

(3) NOTIFICATION ENDORSEMENT. Each policy shall be endorsed to provide that the insurance company agrees that the policy shall not be canceled, changed, allowed to lapse or allowed to expire for any reason until thirty days after the Owner has received written notice by certified mail as evidenced by return receipt or until such time as other insurance coverage providing protection equal to protection called for in the Contract Documents shall have been received, accepted and acknowledged by the Owner. Such notice shall be valid only as to the Project as shall have been designated by Project Name and Number in said notice.

(4) INSURANCE CERTIFICATES. The Contractor shall procure the insurance coverages identified below, or as otherwise required in the Contract Documents, at the Contractor's own expense, and to evidence that such insurance coverages are in effect, the Contractor shall furnish the Owner an insurance certificate(s) acceptable to the Owner and listing the Owner as the certificate holder. The insurance certificate(s) must be delivered to the Owner with the Construction Contract and Bonds for final approval and execution of the Construction Contract. The insurance certificate must provide the following:

- (a) Name and address of authorized agent of the insurance company
- (b) Name and address of insured
- (c) Name of insurance company or companies
- (d) Description of policies
- (e) Policy Number(s)
- (f) Policy Period(s)
- (g) Limits of liability
- (h) Name and address of Owner as certificate holder
- (i) Project Name and Number, if any
- (j) Signature of authorized agent of the insurance company
- (k) Telephone number of authorized agent of the insurance company
- (l) Mandatory thirty day notice of cancellation / non-renewal / change

(5) MAXIMUM DEDUCTIBLE. Self-insured retention, except for qualified self-insurers or

group self-insurers, in any policy shall not exceed \$25,000.00.

B. INSURANCE COVERAGES

Unless otherwise provided in the Contract Documents, the Contractor shall purchase the types of insurance coverages with liability limits not less than as follows:

(1) WORKERS' COMPENSATION and EMPLOYER'S LIABILITY INSURANCE

(a) Workers' Compensation coverage shall be provided in accordance with the statutory coverage required in Alabama. A group insurer must submit a certificate of authority from the Alabama Department of Industrial Relations approving the group insurance plan. A self-insurer must submit a certificate from the Alabama Department of Industrial Relations stating the Contractor qualifies to pay its own workers' compensation claims.

(b) Employer's Liability Insurance limits shall be at least:

- .1 Bodily Injury by Accident - \$1,000,000 each accident
- .2 Bodily Injury by Disease - \$1,000,000 each employee

(2) COMMERCIAL GENERAL LIABILITY INSURANCE

(a) Commercial General Liability Insurance, written on an ISO Occurrence Form (current edition as of the date of Advertisement for Bids) or equivalent, shall include, but need not be limited to, coverage for bodily injury and property damage arising from premises and operations liability, products and completed operations liability, blasting and explosion, collapse of structures, underground damage, personal injury liability and contractual liability. The Commercial General Liability Insurance shall provide at minimum the following limits:

<u>Coverage</u>	<u>Limit</u>
.1 General Aggregate	\$ 2,000,000.00 per Project
.2 Products, Completed Operations Aggregate	\$ 2,000,000.00 per Project
.3 Personal and Advertising Injury	\$ 1,000,000.00 per Occurrence
.4 Each Occurrence	\$ 1,000,000.00

(b) Additional Requirements for Commercial General Liability Insurance:

- .1 The policy shall name the Owner, Architect, Alabama Division of Construction Management, State Department of Education (if applicable), and their agents, consultants and employees as additional insureds, state that this coverage shall be primary insurance for the additional insureds; and contain no exclusions of the additional insureds relative to job accidents.
- .2 The policy must include separate per project aggregate limits.

(3) COMMERCIAL BUSINESS AUTOMOBILE LIABILITY INSURANCE

(a) Commercial Business Automobile Liability Insurance which shall include coverage for bodily injury and property damage arising from the operation of any owned, non-owned or hired automobile. The Commercial Business Automobile Liability Insurance Policy shall provide not less than \$1,000,000 Combined Single Limits for each occurrence.

(b) The policy shall name the Owner, Architect, Alabama Division of Construction Management, State Department of Education (if applicable), and their agents, consultants, and employees as additional insureds.

(4) COMMERCIAL UMBRELLA LIABILITY INSURANCE

(a) Commercial Umbrella Liability Insurance to provide excess coverage above the

Commercial General Liability, Commercial Business Automobile Liability and the Workers' Compensation and Employer's Liability to satisfy the minimum limits set forth herein.

(b) Minimum Combined Primary Commercial General Liability and Commercial/Excess Umbrella Limits of:

- .1 \$ 5,000,000 per Occurrence
- .2 \$ 5,000,000 Aggregate

(c) Additional Requirements for Commercial Umbrella Liability Insurance:

- .1 The policy shall name the Owner, Architect, Alabama Division of Construction Management, State Department of Education (if applicable), and their agents, consultants, and employees as additional insureds.
- .2 The policy must be on an "occurrence" basis.

(5) BUILDER'S RISK INSURANCE

(a) The Builder's Risk Policy shall be made payable to the Owner and Contractor, as their interests may appear. The policy amount shall be equal to 100% of the Contract Sum, written on a Causes of Loss - Special Form (current edition as of the date of Advertisement for Bids), or its equivalent. All deductibles shall be the sole responsibility of the Contractor.

(b) The policy shall be endorsed as follows:

"The following may occur without diminishing, changing, altering or otherwise affecting the coverage and protection afforded the insured under this policy:

- (i) Furniture and equipment may be delivered to the insured premises and installed in place ready for use; or
- (ii) Partial or complete occupancy by Owner; or
- (iii) Performance of work in connection with construction operations insured by the Owner, by agents or lessees or other contractors of the Owner, or by contractors of the lessee of the Owner."

C. SUBCONTRACTORS' INSURANCE

(1) **WORKERS' COMPENSATION and EMPLOYER'S LIABILITY INSURANCE.** The Contractor shall require each Subcontractor to obtain and maintain Workers' Compensation and Employer's Liability Insurance coverages as described in preceding Paragraph B, or to be covered by the Contractor's Workers' Compensation and Employer's Liability Insurance while performing Work under the Contract.

(2) **LIABILITY INSURANCE.** The Contractor shall require each Subcontractor to obtain and maintain adequate General Liability, Automobile Liability, and Umbrella Liability Insurance coverages similar to those described in preceding Paragraph B. Such coverage shall be in effect at all times that a Subcontractor is performing Work under the Contract.

(3) **ENFORCEMENT RESPONSIBILITY.** The Contractor shall have responsibility to enforce its Subcontractors' compliance with these or similar insurance requirements; however, the Contractor shall, upon request, provide the Architect or Owner acceptable evidence of insurance for any Subcontractor.

D. TERMINATION of OBLIGATION to INSURE

Unless otherwise expressly provided in the Contract Documents, the obligation to insure as provided herein shall continue as follows:

(1) BUILDER'S RISK INSURANCE. The obligation to insure under Subparagraph B(5) shall remain in effect until the Date of Substantial Completion as shall be established in the Certificate of Substantial Completion. In the event that multiple Certificates of Substantial Completion covering designated portions of the Work are issued, Builder's Risk coverage shall remain in effect until the Date of Substantial Completion as shall be established in the last issued Certificate of Substantial Completion. However, in the case that the Work involves separate buildings, Builder's Risk coverage of each separate building may terminate on the Date of Substantial Completion as established in the Certificate of Substantial Completion issued for each building.

(2) PRODUCTS and COMPLETED OPERATIONS. The obligation to carry Products and Completed Operations coverage specified under Subparagraph B(2) shall remain in effect for two years after the Date(s) of Substantial Completion.

(3) ALL OTHER INSURANCE. The obligation to carry other insurance coverages specified under Subparagraphs B(1) through B(4) and Paragraph C shall remain in effect after the Date(s) of Substantial Completion until such time as all Work required by the Contract Documents is completed. Equal or similar insurance coverages shall remain in effect if, after completion of the Work, the Contractor, a Subcontractor, anyone directly or indirectly employed by them or anyone for whose acts they may be liable, returns to the Project to perform warranty or maintenance work pursuant to the terms of the Contract Documents.

E. WAIVERS of SUBROGATION

The Owner and Contractor waive all rights against (1) each other and any of their subcontractors, sub-subcontractors, agents and employees, each of the other, and (2) the Architect, Architect's consultants, separate contractors performing construction or operations related to the Project, if any, and any of their subcontractors, sub-subcontractors, agents and employees, for damages caused by fire or other causes of loss. But said waiver shall apply only to the extent the loss or damage is covered by builder's risk insurance applicable to the Work or to other property located within or adjacent to the Project, except such rights as they may have to proceeds of such insurance held by the Owner or Contractor as fiduciary. The Owner or Contractor, as appropriate, shall require of the Architect, Architect's consultants, separate contractors, if any, and the subcontractor, sub-subcontractors, suppliers, agents and employees of any of them, by appropriate agreements, written where legally required for validity, similar waivers each in favor of other parties enumerated herein. The Policies shall provide such waivers of subrogation by endorsement or otherwise. A waiver of subrogation shall be effective as to the person or entity even though that person or entity would otherwise have a duty of indemnification, contractual or otherwise, did not pay the insurance premium directly or indirectly, and whether or not the person or entity had an insurable interest in the property damaged. The waivers provided for in this paragraph shall not be applicable to loss or damage that occurs after final acceptance of the Work.

DCM (BC) No. _____

PSCA Projects: PSCA No. _____

Application No. _____

Date: _____

APPLICATION and CERTIFICATE for PAYMENT

Attach DCM Form C-10SOV Schedule of Values

TO OWNER: Entity Name: _____ Address _____	PROJECT: _____
FROM CONTRACTOR: Company Name _____ Address _____	ARCHITECT/ENGINEER: Firm Name _____ Address _____

Total Original Contract	\$
Fully Executed Change Order(s) Numbers ___ through ___	\$
Total Contract To Date	\$

1. Work Completed to Date per attached Schedule of Values	\$
2. Stored Materials <i>(Attach list or Form DCM C10-SM, Inventory of Stored Materials)</i>	\$
3. Total Completed Work and Stored Materials (___ % of Contract To Date)	\$
4. Less Retainage <i>(5% of Total Completed Work & Stored Materials [TCWSM] is retained when TCWSM is less than 50% of Total Contract To Date [TCTD]. 0 is retained on final pay. app.)</i>	(\$)
5. Total Due	\$
6. Less Total Previous Payments	(\$)
7. Balance Due This Estimate	\$

CONTRACTOR'S CERTIFICATION

The undersigned Contractor certifies that to the best of his knowledge, information, and belief the Work covered by this Application for Payment has been completed in accordance with the Contract Documents, that all amounts have been paid by him for Work for which previous Certificates for Payments were issued and payments received from the Owner and that current payment shown herein has not yet been received.

By _____ Date _____
Contractor's Signature

Name & Title _____

Sworn and subscribed before me this _____ day of _____
Seal Day Month, Year

Notary Public's Signature

ARCHITECT'S/ENGINEER'S CERTIFICATION

In accordance with the Contract Documents, the Architect/Engineer certifies to the Owner that, to the best of the Architect's/Engineer's knowledge and belief, the Work has progressed to the point indicated herein, the quality of the Work is in accordance with the Contract Documents, and the Contractor is entitled to payment of the amount approved.

By _____
Architect's/Engineer's Signature

Name & Title _____

Date _____

INSTRUCTIONS

- Four copies of pay app. each with original signatures and all attachments required
- Date of first payment application cannot precede the Notice to Proceed's Begin Date
- Pay app must exactly match an attached DCM Form C-10SOV Schedule of Values
- A change order must be fully executed before inclusion on a payment application.
- On a final payment application, all change orders must be fully executed and included
- Contractor's signature date cannot precede the payment application date
- Progress schedules must be included with non-final payment applications.
- One payment application per month may be submitted.
- Retainage is released when the Certificate of Substantial Completion is fully executed, all other close-out requirements per General Conditions Article 34 are completed and the final payment application is reviewed, approved and processed
- DCM processes pay apps of state agencies, PSCA and other bond-funded projects.

APPROVAL

Owner Entity

By _____
Signature

Name & Title _____

Date _____

SAMPLE PROGRESS SCHEDULE & REPORT

DCM (BC) No.:

PSCA projects: PSCA No.:

PROJECT:

CONTRACTOR (Contractor may use own form in lieu of Form C-11):

ARCHITECT/ENGINEER:

DATE OF REPORT:

PROCEED DATE:

PROJECTED COMPLETION DATE:

WORK DIVISION	%	AMOUNT																	
1. GENERAL REQUIREMENTS																			
2. SITEWORK																			
3. CONCRETE																			
4. MASONRY																			
5. METALS																			
6. WOOD AND PLASTIC																			
7. THERMAL AND MOISTURE PROTECTION																			
8. DOORS AND WINDOWS																			
9. FINISHES																			
10. SPECIALTIES																			
11. EQUIPMENT																			
12. FURNISHINGS																			
13. SPECIAL CONSTRUCTION																			
14. CONVEYING SYSTEMS																			
15. MECHANICAL																			
16. ELECTRICAL																			
TOTAL ORIG. CONTRACT	100%																		
ANTICIPATED DRAW IN \$1,000																			
ACTUAL DRAW IN \$1,000																			

LEGEND: ANTICIPATED ACTIVITY

ACTUAL ACTIVITY

ANTICIPATED CASH FLOW

ACTUAL CASH FLOW

USE ADDITIONAL SHEETS IF JOB IS SCHEDULED OVER 12 MONTHS.

TO: Alabama Department of Finance
Real Property Management
Division of Construction Management
 770 Washington Avenue, Suite 444
 Montgomery, Alabama 36104
 (334) 242-4082 FAX (334) 242-4182

CHANGE ORDER JUSTIFICATION

Change Order No. _____

Date: _____

DCM (BC) No. _____

*Purpose and instructions on next page.
 Do not staple this form and/or attachments; use clips.*

(A)	PROJECT NAME & LOCATION:	OWNER ENTITY NAME & ADDRESS:						
	CONTRACTOR COMPANY NAME & ADDRESS:	ARCHITECTURAL / ENGINEERING FIRM NAME & ADDRESS:						
(B)	DESCRIPTION OF PROPOSED CHANGE(S): ATTACH CONTRACTOR'S DETAILED COST PROPOSAL(s)							
	AMOUNT: <input type="checkbox"/> ADD <input type="checkbox"/> DEDUCT \$ _____ TIME EXTENSION: _____ CALENDAR DAYS							
(C)	<table style="width:100%; border-collapse: collapse;"> <tr> <td style="width:33%;">ORIGINAL CONTRACT AMOUNT</td> <td style="width:33%;">PREVIOUS C.O.'s _____ THRU _____</td> <td style="width:34%;">CONTRACT AMOUNT PRIOR TO PROPOSED CHANGE ORDER</td> </tr> <tr> <td>\$ _____</td> <td>+ \$ _____</td> <td>= \$ _____</td> </tr> </table>		ORIGINAL CONTRACT AMOUNT	PREVIOUS C.O.'s _____ THRU _____	CONTRACT AMOUNT PRIOR TO PROPOSED CHANGE ORDER	\$ _____	+ \$ _____	= \$ _____
ORIGINAL CONTRACT AMOUNT	PREVIOUS C.O.'s _____ THRU _____	CONTRACT AMOUNT PRIOR TO PROPOSED CHANGE ORDER						
\$ _____	+ \$ _____	= \$ _____						
(D)	JUSTIFICATION FOR NEED OF CHANGE(S):							
(E)	JUSTIFICATION OF CHANGE ORDER vs. COMPETITIVE BID:							
(F)	ARCHITECT / ENGINEER'S EVALUATION OF PROPOSED COST:							
(G)	CHANGE ORDER RECOMMENDED _____ ARCHITECTURAL / ENGINEERING FIRM NAME By: _____ ARCHITECT / ENGINEER'S SIGNATURE By: _____ OWNER'S PROJECT REPRESENTATIVE'S SIGNATURE	CHANGE ORDER JUSTIFIED AND APPROVED _____ LOCAL OWNER ENTITY NAME By: _____ OWNER'S SIGNATURE By: _____ OWNER'S LEGAL COUNSEL'S SIGNATURE						

CHANGE ORDER JUSTIFICATION: PURPOSE and INSTRUCTIONS

PURPOSE

The awarding of work through an existing contract may potentially conflict with, or violate, the "Competitive Bid Laws" of the State of Alabama. **The determination of legality of Change Orders rests with the Awarding Authority and its legal advisor.** In a June 15, 1979, Opinion, the Office of the Attorney General offered guidelines for making such determinations in conjunction with considering the facts and merits of each situation. The purpose of the CHANGE ORDER JUSTIFICATION is to provide a means through which the Awarding Authority considers these guidelines and the intent of the "Competitive Bid Laws" when authorizing Change Orders. Pursuant to these guidelines, the following types of changes meet the criteria for awarding work through Change Orders in lieu of through the Competitive Bid process:

- I. Minor Changes for a monetary value less than required for competitive bidding.
- II. Changes for matters relatively minor and incidental to the original contract necessitated by unforeseeable circumstances arising during the course of the work.
- III. Emergencies arising during the course of the work of the contract.
- IV. Bid alternates provided for in the original bidding where there is no difference in price of the change order from the original best bid on the alternate.
- V. Changes of relatively minor items not contemplated when the plans and specifications were prepared and the project was bid which are in the public interest and which do not exceed 10% of the contract price.

Under these guidelines the cumulative total of Change Orders, including any negotiations to bring the original contract price within the funds available, would become questionable if the total of such changes and negotiations exceed 10% of the original contract price. These guidelines are not intended to interfere with the Awarding Authority's good faith discretion to respond to specific situations in the public's best interest. If the cumulative change order amount exceeds 10% of the original contract amount then the Owner's legal consultant must sign the Change Order Justification prior to submission to the Division of Construction Management (DCM).

INSTRUCTIONS

The CHANGE ORDER JUSTIFICATION is to be prepared by the design professional, who has evaluated the fairness and reasonableness of the proposed cost of the change(s) and recommends that the proposed Change Order be executed. The fully executed Form B-11: CHANGE ORDER JUSTIFICATION must accompany the proposed DCM Form C-12: Change Order. Instructions for completing the B-11 form are:

1. Insert the proposed Change Order Number, date of the Justification, and DCM (BC) Project Number in the spaces provided in the upper right-hand corner.
2. **Section (A):** Insert the complete name and address of the PROJECT, OWNER, CONTRACTOR, AND ARCHITECT/ENGINEER.
3. **Section (B):** Provide a complete description of the proposed changes in work, referring to and attaching revised specifications and/or drawings as appropriate. An attachment may be used if additional space is needed, but insert the proposed amount and time extension of the change(s) in the spaces provided. **Attached a copy of the contractor's detailed cost proposal.**
4. **Section (C):** Insert the Original Contract amount, the net increase or decrease of previous Change Orders, and the Current Contract amount (preceding the currently proposed Change Order).
5. **Section (D):** Explain why it is necessary, or in the public's interest, to make the proposed change(s) to the Work.
6. **Section (E):** Explain why award of the changed work to the existing contractor instead of awarding the work under the competitive bid process is justified.
7. **Section (F):** The design professional must state his evaluation of the reasonableness and fairness of the proposed costs based upon his review of the contractor's proposal.
8. **Section (G):** The design professional must recommend the Change Order to the Owner by signing the document; the Owner may require such recommendation from other individuals. The Owner must sign the document indicating that they believe change order action in lieu of the competitive bid process is justified for the proposed change(s). **Review of the matter and signing of the document by the Owner's legal counsel is highly recommended. If the cumulative change order amount exceeds 10% of the original contract amount then the Owner's legal consultant must sign the Change Order Justification prior to submission to DCM.**

CONTRACT CHANGE ORDER

Change Order No. _____ Date _____ DCM (BC) No. _____

TO: (Contractor) Co. Name: Address:	PROJECT:
--	-----------------

TERMS: You are hereby authorized, subject to the provisions of your Contract for this project, to make the following changes thereto in accordance with your proposal(s) dated _____

FURNISH the necessary labor, materials, and equipment to *(Description of work to be done or changes to be made. If the description is continued in an attachment, identify the attachment below.)*:

Description continued from Page 1:

ORIGINAL CONTRACT SUM	\$ _____
NET TOTAL OF PREVIOUS CHANGE ORDERS	\$ _____
PREVIOUS REVISED CONTRACT SUM	\$ _____
THIS CHANGE ORDER WILL <input type="checkbox"/> INCREASE <input type="checkbox"/> DECREASE THE CONTRACT SUM BY	\$ _____
REVISED CONTRACT SUM, INCLUDING THIS CHANGE ORDER	\$ _____

EXTENSION OF TIME resulting from this Change Order None or _____ Calendar days.

The Owner does hereby certify that this Change Order was executed in accordance with the provisions of Title 39, Code of Alabama, 1975, as amended.

_____ Architectural/Engineering Firm
Recommended By _____ Name & Title _____

APPROVAL

ALABAMA STATE DEPARTMENT OF EDUCATION (SDE) <i>(Required for locally-funded, SDE projects.)</i>	
By _____	Date _____
State Superintendent of Education	

CONTRACTING PARTIES

_____ Contractor Company
By _____ Name & Title _____

_____ Awarding Authority/Owner Entity
By _____ Name & Title _____

CONSENT OF SURETY (for additive \$ change orders only)	
_____ Surety Company	
By _____ (Attach current Power of Attorney)	Name & Title _____

Review/Signature flow: Architect/Engineer (prepare documents) > Contractor (review and sign) (> Surety for additive \$ change orders only [sign]) > Architect/Engineer (review and sign) > Owner (review and sign) > SDE (review, sign, distribute the fully executed Change Order to all parties and forward a copy to the Alabama Division of Construction Management [DCM]). Note: DCM does not sign fully locally-funded SDE project contract documents.

TO: **Alabama Department of Finance**
Real Property Management
Division of Construction Management
770 Washington Avenue, Suite 444
Montgomery, AL 36130-1150
(334) 242-4082 FAX (334) 242-4182

CERTIFICATE OF SUBSTANTIAL COMPLETION

*Do not staple this form and/or attachments, use clips.
Print single-sided, do not submit double-side printed documents.*

ROUTING PROCEDURES ON NEXT PAGE

DCM (BC) No. _____

OWNER ENTITY NAME AND ADDRESS: Email to receive executed copy: _____	ARCHITECTURAL / ENGINEERING FIRM NAME AND ADDRESS: Email to receive executed copy: _____
CONTRACTOR COMPANY NAME AND ADDRESS: Email to receive executed copy: _____	BONDING COMPANY NAME AND ADDRESS: Email to receive executed copy: _____
PROJECT: 	

Substantial Completion has been achieved for the entire Work the following portion of the Work:

The **Date of Substantial Completion** of the Work covered by this certificate is established to be _____

"Substantial Completion" means the designated Work is sufficiently complete, in accordance with the Contract Documents, such that the Owner may occupy or utilize the Work for its intended use without disruption or interference by the Contractor in completing or correcting any remaining unfinished Work. The Date of Substantial Completion is the date upon which all warranties for the designated Work commence, unless otherwise agreed and recorded herein.

Punch List: A _____ page list of items to be completed or corrected prior to the Owner's approval of Final Payment is attached hereto, but does not alter the Contractor's responsibility to complete or correct all Work in full compliance with the Contract Documents. The Contractor shall complete or correct all items on the attached list, ready for re-inspection for Final Acceptance, within 30 days after the above Date of Substantial Completion, unless another date is stated here: _____
If completed or corrected within this period, warranties of these items commence on the Date of Substantial Completion, otherwise such warranties commence on the date of Final Acceptance of each item.

Only one (1) originally executed substantial completion form shall be routed for signature. DCM office will mail the fully-executed original to the Owner and email copies to all parties.

RECOMMENDED BY <i>(signature and email address required):</i>	
ARCHITECT/ENGINEER: _____	DATE: _____
CONTRACTING PARTIES:	
CONTRACTOR: _____	DATE: _____
OWNER: _____	DATE: _____
_____	DATE: _____
APPROVALS:	
DCM INSPECTOR: _____	DATE: _____
DCM CHIEF INSPECTOR: _____	DATE: _____
DCM DIRECTOR: _____	DATE: _____

CERTIFICATE OF SUBSTANTIAL COMPLETION ROUTING PROCEDURE

Only one (1) originally executed substantial completion form shall be routed for signature. DCM office will mail the fully-executed original to the owner and email copies to all parties.

ARCHITECT/ENGINEER: Sign and date document, then mail it to Contractor. Provide Owner with DCM Inspector's name & field office address; territories and addresses are available at www.dcm.alabama.gov/staff.aspx.

CONTRACTOR: Sign and date document, then mail it to Owner.

OWNER: Sign and date document, then mail it to DCM Inspector's field office address; DCM Inspector territories and addresses are available at www.dcm.alabama.gov/staff.aspx.

DCM INSPECTOR: Sign and date document, then mail it to DCM Montgomery office.

DCM OFFICE: After review and signature/date by DCM Chief Inspector and DCM Director, DCM office will mail the fully-executed original document to Owner and will email copies to all parties.

NOTICE

THE EXECUTED "GENERAL CONTRACTOR'S ROOFING GUARANTEE" (DCM Form C-9) AND ANY OTHER ROOFING WARRANTY REQUIRED BY THE CONTRACT MUST ACCOMPANY THIS CERTIFICATE TO OBTAIN DCM APPROVAL.

SAMPLE FORM OF ADVERTISEMENT FOR COMPLETION

LEGAL NOTICE

In accordance with Chapter 1, Title 39, Code of Alabama, 1975, as amended, notice is hereby given

that _____,
(Contractor Company Name)

Contractor, has completed the Contract for (Construction) (Renovation) (Alteration)
 (Equipment) (Improvement) of _____
(Name of Project):

at _____,
(Insert location data in County or City)

for the State of Alabama and the (County) (City) of _____,
Owner(s), and have made request for final settlement of said Contract. All persons having
any claim for labor, materials, or otherwise in connection with this project should immediately
notify

(Architect / Engineer)

(Contractor)

(Business Address)

NOTE: This notice must be run once a week for four successive weeks for projects exceeding \$50,000.00. For projects of \$50,000.00 or less, run one time only. A copy of the publisher's affidavit of publication (including a copy of the advertisement) shall be submitted by the Contractor to the Design Professional for inclusion with DCM Form B-13: Final Payment Checklist for state agencies, PSCA-funded and other bond-funded projects.

DETAIL OF PROJECT SIGN

N.T.S.

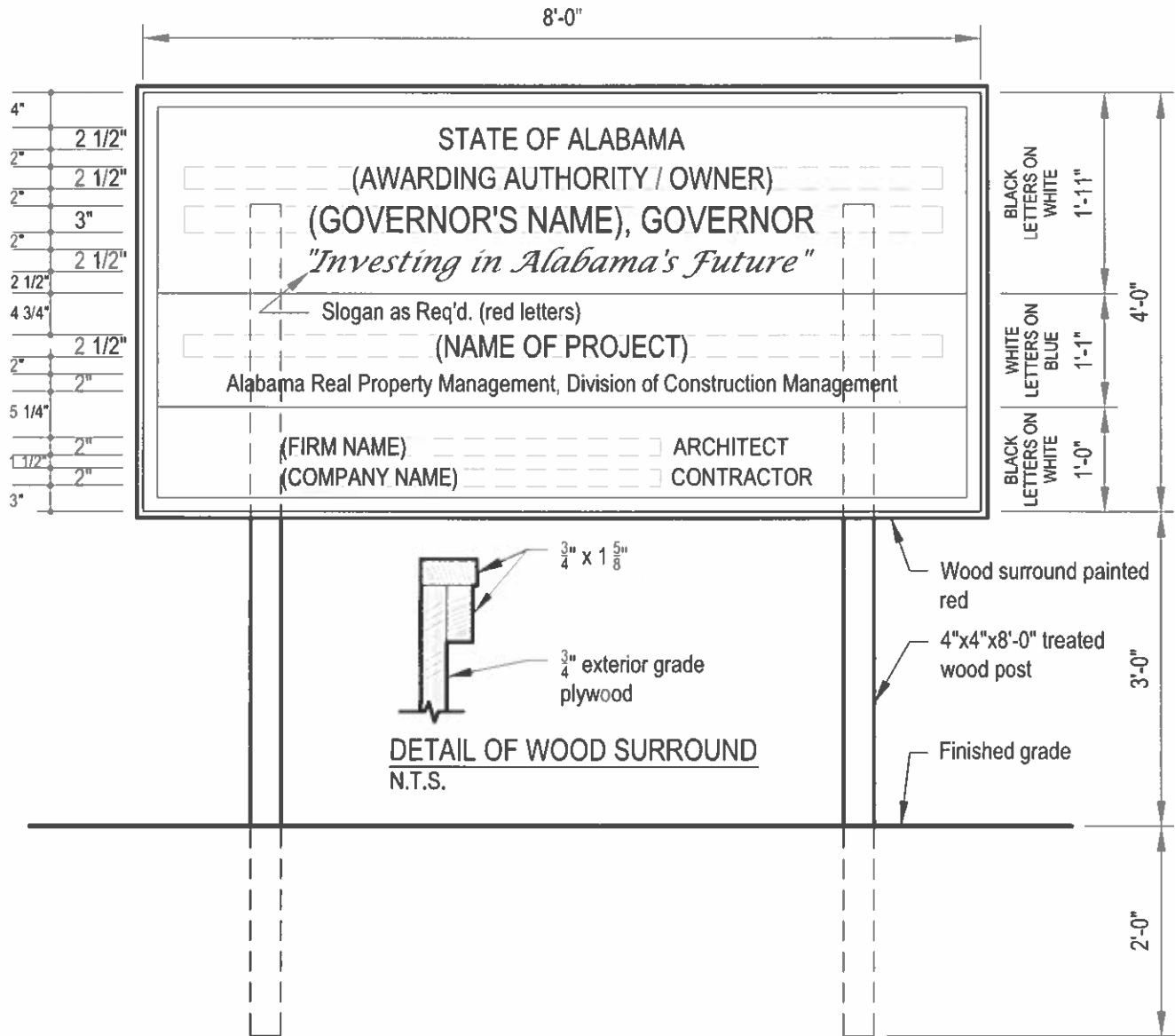

Notes:

1. Fully locally-funded State Agency and Public Higher Education projects: DCM Form C-15 must be included in the project manual regardless of expected bid amount. If the awarded contract sum is \$100,000.00 or more, Contractor shall furnish and erect a project sign.
Fully locally-funded K-12 school projects: Project sign is not required unless requested by Owner, if project sign is requested by Owner, include DCM Form C-15 in the project manual.
Partially or fully PSCA-funded projects: DCM Form C-15 must be included in the project manual. Contractor shall furnish and erect a project sign for all PSCA-funded projects, regardless of contract sum. "Alabama Public School and College Authority" as well as the local owner entity must be included as awarding authorities on the project sign of all PSCA-funded projects.
2. Sign to be constructed of $\frac{3}{4}$ " exterior grade plywood.
3. Paint with two coats best grade exterior paint before letters are painted. Option: In lieu of painted lettering on plywood, a corrugated plastic sign (displaying the same lettering, layout and colors as above) may be secured directly to the unpainted exterior grade plywood.
4. Sign shall be placed in a prominent location and easily readable from existing street or roadway.
5. Sign shall be maintained in good condition until project completion.
6. Slogan: Act 2020-167's title "Investing In Alabama's Future" should be placed on the project signs of all PSCA-funded projects, otherwise the Awarding Authority/Owner's slogan, if any, should be used. If the Awarding Authority/Owner of a fully locally-funded project does not have a slogan, the project sign does not require a slogan.

DCM (BC) Number: _____
PSCA Projects: PSCA Number: _____
Date of the Construction Contract: _____

Contractor's Affidavit of Payment of Debts and Claims

To Owner (<i>Entity name and address</i>):	Project (<i>Same as appears in the Construction Contract</i>):
---	---

STATE OF:

COUNTY OF:

The undersigned hereby certifies that, except as listed below, payment has been made in full and all obligations have otherwise been satisfied for all materials and equipment furnished, for all work, labor and services performed, and for all known indebtedness and claims against the Contractor for damages arising in any manner in connection with the performance of the Construction Contract referenced above for which the Owner or Owner's property might in any way be held responsible or encumbered.

EXCEPTIONS:

Supporting Documents Attached Hereto:

1. Consent of Surety to Final Payment. Whenever Surety is involved, Consent of Surety is required. DCM Form C-20, Consent of Surety to Final Payment, may be used for this purpose.

Indicate attachment: Yes No

The following supporting document should be attached hereto if required by the Owner:

1. Contractor's Release of Waiver of Liens.
2. Separate Releases or Waivers of Liens from Subcontractors and material and equipment supplies, to the extent required by the Owner, accompanied by the list thereof.
3. Contractor's Affidavit of Release of Liens, DCM Form C-19.

Contractor (*Insert company name and address*):

By: _____
Signature of authorized representative

Name and Title

Sworn to and subscribed before me this _____ day
of _____, _____.

Notary Public's Signature

My commission expires: _____

Seal:

DCM (BC) Number: _____
PSCA Projects: PSCA Number: _____
Date of the Construction Contract: _____

Contractor's Affidavit of Release of Liens

To Owner (<i>Entity name and address</i>):	Project (<i>Same as appears in the Construction Contract</i>):

STATE OF:

COUNTY OF:

The undersigned hereby certifies that, except as listed below, the Releases or Waivers of Lien attached hereto include the Contractor, all Subcontractors, all suppliers of materials and equipment, and all performers of Work, labor or services who have or may have liens or encumbrances or the right to assert liens or encumbrances against any property of the Owner arising in any manner out of the performance of the Construction Contract referenced above.

EXCEPTIONS:

Supporting Documents Attached Hereto:

1. Contractor's Release of Waiver of Liens.
2. Separate Releases or Waivers of Liens from Subcontractors and material and equipment supplies, to the extent required by the Owner, accompanied by the list thereof.

Contractor (*Insert company name and address*):

By: _____
Signature of authorized representative

Name and Title

Sworn to and subscribed before me this _____ day
of _____, _____.

Notary Public's Signature

My commission expires: _____

Seal:

DCM (BC) Number: _____
PSCA Projects: PSCA Number: _____
Date of the Construction Contract: _____
Surety's Bond Number: _____

CONSENT OF SURETY TO FINAL PAYMENT

To Owner (<i>Entity name and address</i>):	Project (<i>Same as appears in the Construction Contract</i>):
---	---

In accordance with the provisions of the Contract between the Owner and the Contractor as indicated above, the
Surety (*Insert name and address of Surety*)

on bond of
Contractor (*Insert name and address of Contractor*)

hereby approves of the final payment to the Contractor, and agrees that final payment to the Contractor shall not relieve the Surety of any of its obligations to
Owner (*Insert name and address of Entity*):

as set forth in said Surety's bond.

SIGNED AND SEALED this _____ day of _____, _____.

SURETY:

Company Name

Seal:

By _____
Signature of Authorized Representative

Printed Name and Title

Note: Original Power of Attorney for the Surety's signatory shall be furnished with each of the original forms to be attached to each of the four (4) final payment forms.

PLAYGROUND EQUIPMENT AND INSTALLATION
WILMER ELEMENTARY SCHOOL

Scope of Work

The successful bidder will be responsible for the following:

- 1) Furnishing and installing playground structures as described in the specifications.
- 2) Bidder must be the manufacturer's authorized installer and the equipment must be installed according to manufacturer's specifications.
- 3) There will be no borders or wood mulch surfacing used in this project.
- 4) Our intent by providing the detailed specifications is to establish a benchmark of quality and to express the needs of the school. We encourage all vendors to submit their product they consider as an equal, or will exceed the specifications listed.

Acceptable Unit: Playcraft Systems; or approved equal.

Wilmer Elementary School – Playground Upgrades Specifications

SITE PLAN – Playground

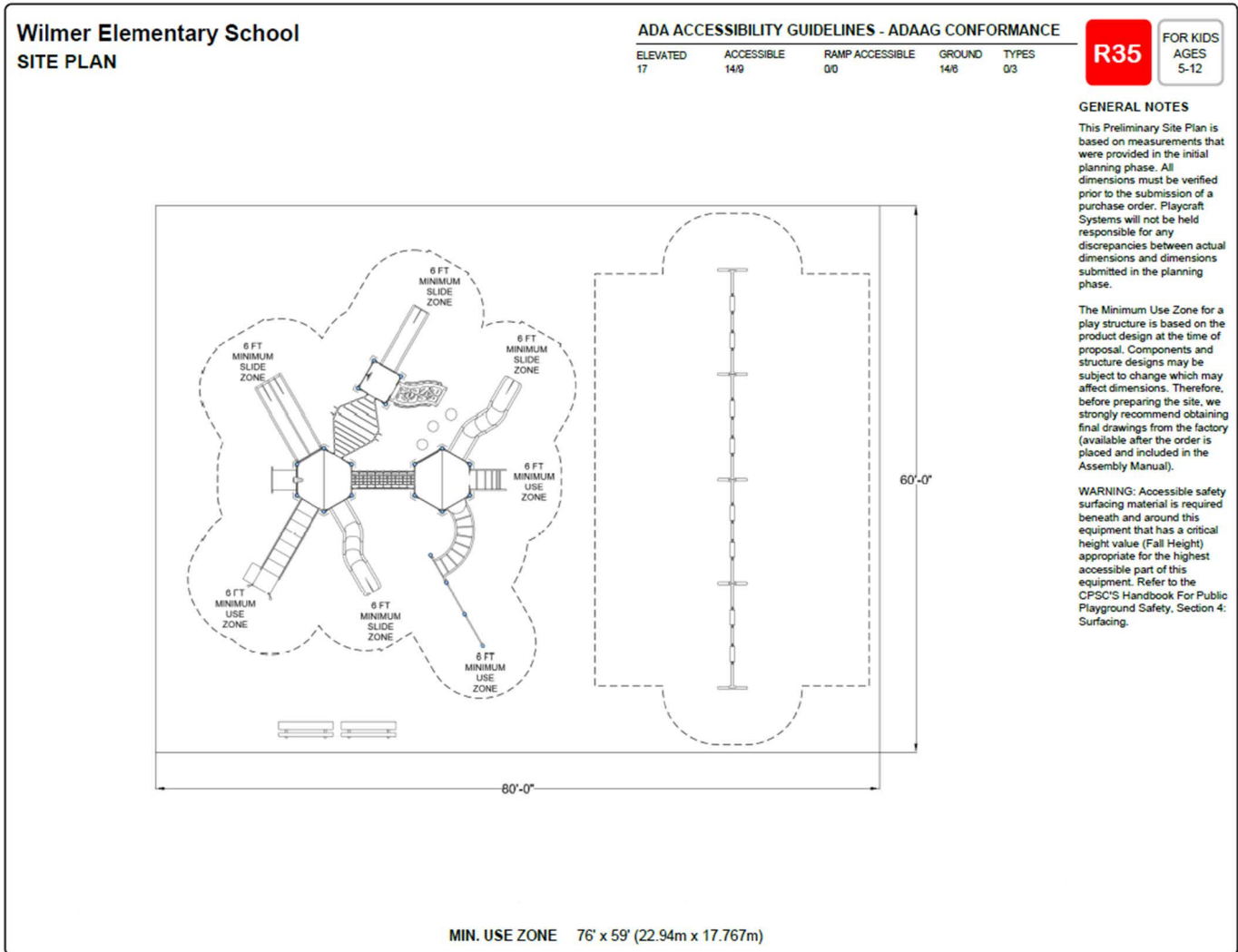

PLAY EQUIPMENT GENERAL SPECIFICATIONS - PLAYCRAFT SYSTEMS OR APPROVED EQUAL.

Hardware

Metal Hardware shall be zinc plated, galvanized, or made of stainless steel as required to resist rust and corrosion. Tamper resistant hardware shall be used for all principal connections. Stainless Steel Hardware shall be stainless steel as required to resist rust & corrosion. Tamper resistant hardware shall be used for all principal connections. Zinc and Stainless Steel Hardware shall be zinc plated, or made of stainless steel as required to resist rust & corrosion. Stainless Steel Hardware shall be galvanized or made of stainless steel as required to resist rust and corrosion. Hardware Caps shall be a UV-Stabilized, polypropylene based plastic consisting of two parts, a base and crown. Specified hardware is attached through the base to post support and then finished with a crown to form a smooth tamper-resistant attachment point.

Post Caps

Post Caps shall be precision die-cast from a high strength aluminum alloy and powder coated as specified. Post caps shall be of a self-sealing design with an overlapping lip and are factory installed and secured in place with a self-sealing rivet. System shall be available for Round-5 and Round-3.5 systems.

Chain

Chain used for Swings, Chain Nets, Chain Walks and Suspension Bridges shall be 4/0 and/or 5/0 galvanized steel. Chains shall be thermoplastic coated as required.

High Density Polyethylene Panels

High Density Polyethylene - (HDPE) Sheet Stock Parts shall be made from 1/2", 3/4" or 1" thick, high-density, hot extruded polyethylene sheet plastic specially formulated for optimum UV stability and color retention. Parts shall meet or exceed density of .955 g/cc per ASTM D1505, tensile strength of 4000 PSI per ASTM D638. Panels are cut or machined to size with design elements routed in. Parts are available in a variety of solid or dual-color designs. All HDPE Sheet Stock Parts shall comply to ASTM standards: D790 (Flex Modulus Test), D648 (Heat Distortion Temperature Test).

Metal Parts

Metal Parts shall be zinc or cadmium plated, galvanized, Play-Tuff™ coated, painted and/or powder coated as required to resist rust and corrosion.

Tube Steel

Tube Steel used in most applications shall be heavy-gauge and pre-galvanized. Tube shall be formed and/or fabricated into required components and finished as specified. All Steel Tube parts shall comply with ASTM standards: A-500/A-513 (Steel Tubing).

Powder Coating

Powder Coating shall be electrostatically applied to metal components. Surfaces shall be free of excess weld and spatter. Components shall be shot blasted and then further cleaned in a multi-step process that includes a hot phosphating bath and rinse and finished with a non-chrome seal for added corrosion resistance. Additionally, components shall be preheated to fully dry prior to coating for superior powder adhesion. Finally, powder shall be applied to all pre-treated components in a two-coat process to achieve an average thickness of 11 mils. All polyester powder coatings shall comply with ASTM standards: D-522 (Flexibility Mandrel Test), D-2794 (Impact Resistance Test), B-117 (Salt Spray Weatherability Test), D-3363 (Pencil Hardness Test), D-2454 (Overbake Resistance Test), D-3359B (Adhesion Crosshatching Test).

PVC Coating

PlayTuff™ (PVC Coating) shall be applied to metal components for a 100 mil. minimum average thickness. Prior to coating, components shall be washed, phosphated and primed. After preheating to a minimum of 350 degrees, components shall be dipped in a UV stabilized Polyvinyl Chloride liquid & shall be salt cured at 400 degrees. All Play-Tuff™ Coated Parts shall comply to ASTM standards: D-624 (Tear Strength Test), D-412 (Tensile Strength Test).

Rotationally Molded Parts

RotoMold shall be made from hot compounded linear low density polyethylene resins. Hot compounded polyethylene resins offer superior durability and fade resistance from UV inhibitors and colorants molded-in. All linear low density polyethylene plastic shall have a minimum 2500 PSI tensile strength per ASTM D 638-02. Parts shall have an average wall thickness of .250". Parts are available in a variety of solid colors. All RotoMolded Parts shall comply with ASTM standards: D-790 (Flex Modulus Test), D-648 (Heat Distortion Temperature Test), ARM-STD (Low Temperature Impact Test).

Steel Decking

Steel Decks Steps (platforms, bridges, ramps, steps, etc.) shall be constructed using a combination of 12 gauge sheet steel which shall be formed and fabricated into required designs with deck sides and additional parts of deck being fabricated out of 10 or 12 gauge sheet steel. All steel deck standing surfaces and stepping surfaces shall have a slip-resistant Play-Tuff™ coating minimum of 100 mil average thickness, with a uniform 5/16" diameter hole pattern. Deck faces shall have up to 6 attachment slots (a Playcraft Systems Exclusive) to accommodate face mounting components. All sheet steel shall conform to ASTM A 1011-02. IMPORTANT: Inferior expanded steel shall not be used on any decks or stepping surfaces.

Steel Walls

Steel Walls shall be fabricated using 1.029" O.D. 14 gauge tube steel welded vertically on 4" centers between vertical 1.315" O.D. 12 gauge tube steel balusters and horizontal 1.315" O.D. 12 gauge tube steel rails, top & bottom. Brackets may be welded to the ends of each rail and between the verticals to provide attachment points. Walls shall be finished with a multi-stage baked-on powder coat finish.

PLAY STRUCTURE

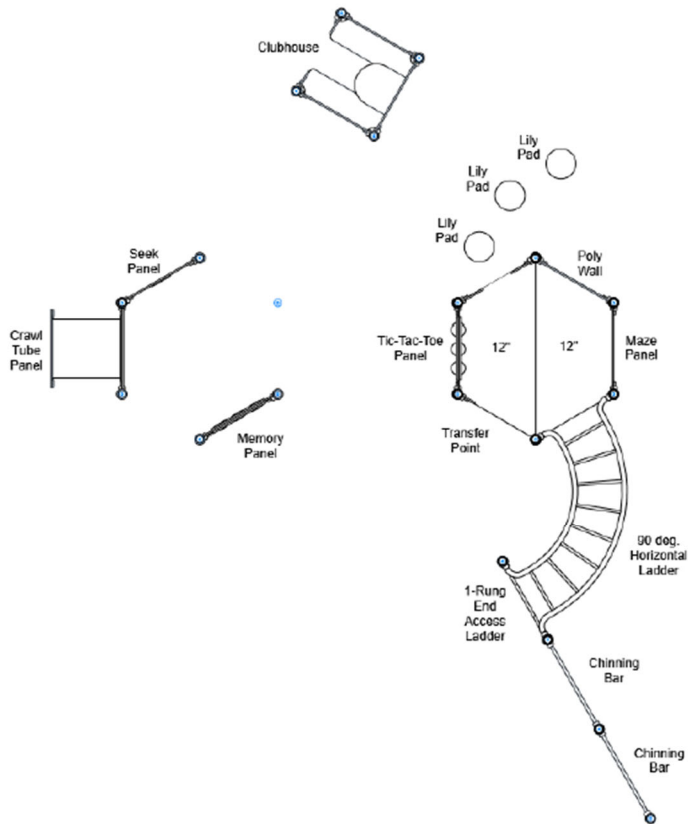

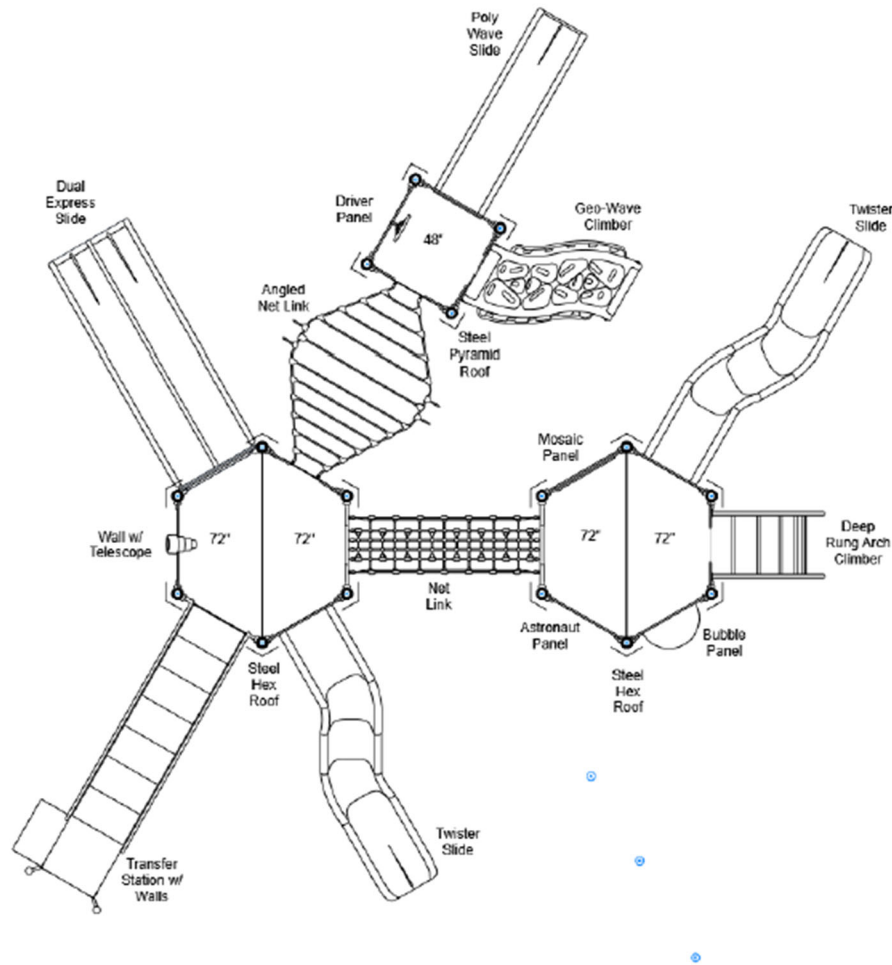

R35-1600 - R3.5 Panel Assembly

The R3.5 Panel shall be made from high density 3/4" sheet plastic specially formulated for optimum UV stability and color retention. The R3.5 Panel Bracket shall be precision cut from 3/16" HR sheet steel and will be Powder Coated as specified. The Mounting Lugs shall be precision die-cast from a high-strength aluminum alloy and will be Powder Coated as specified. The Socket Clamps shall be two-part and precision die-cast from a high strength aluminum alloy and will be Powder Coated as specified.

R35 1429 - 90 Deg. Horizontal Ladder

The Horizontal Ladder support beams shall be fabricated from 2.375" O.D. 10 gauge tube steel with 1.315" O.D. 12 gauge tube steel rungs uniformly spaced and welded in place and will be Powder Coated as specified.

R35 1309 - R3.5 Half Wall

R3.5 HALF WALL: Shall be made from high density 3/4" sheet plastic specially formulated for optimum UV stability and color retention. R3.5 PANEL BRACKET: Shall be precision cut from 3/16" HR sheet steel. The R3.5 Panel Bracket shall have a multi-stage baked-on powder coat finish. MOUNTING LUGS: Shall be precision die-cast from a high-strength aluminum alloy. The Mounting Lugs have a multi-stage baked-on powder coat finish. SOCKET CLAMPS: Shall be two-part and precision die-cast from a high strength aluminum alloy. The Socket Clamps have a multi-stage baked-on powder coat finish.

R35 1305 - Double Sit Down R3.5

The Double Sit Down and Back Panel shall be made from high density 3/4" sheet plastic specially formulated for optimum UV-Stability and color retention. The Double Sit Down Leg shall be fabricated from 1.029" O.D. 14 gauge tube steel and will be Powder Coated as specified. The Mounting Blocks shall be two-part precision die-cast from a high strength aluminum alloy and will be Powder Coated as specified.

R35 1304 - Sit Down Wall R3.5

The Sit Down Wall and Spacers high density 3/4" sheet plastic specially formulated for optimum UV-stability and color retention. The Mounting Lugs shall be precision die-cast from a high strength aluminum alloy and will be Powder Coated as specified.

R35 1301 - R3.5 Wall Assembly

The R3.5 Wall shall be made from high-density, 3/4" thick, hot extruded polyethylene sheet plastic specially formulated for optimum UV stability and color retention. The R3.5 Panel Bracket shall be precision cut from 3/16" HR sheet steel and will be

Powder Coated as specified. The Socket Clamps shall be two-part and precision die-cast from a high strength aluminum alloy and will be Powder Coated as specified. The Mounting Lug shall be precision die-cast from a high strength aluminum alloy and will be Powder Coated as specified.

16801 - Tube End Panel

The Crawl Tube End Panel, Stiffeners and Extension Legs shall be made from high density 3/4" sheet plastic specially formulated for optimum UV stability and color retention. The Tube Section shall be constructed of UV-stabilized rotationally molded, linear, low density polyethylene with an average wall thickness of .250".

1930 - Chinning Bar

The Chinning Bar R5 & R35 shall be fabricated using 1.315" O.D. 12 gauge steel tubing and shall have a powder coat finish. The Chinning Bar R5 Hybrid & RV shall be fabricated using 1.315" O.D. 12 gauge steel tubing with welded 1/4" thick steel mounting brackets and shall have a powder coat finish. The Socket Clamps shall be two-part and precision die-cast from a high strength aluminum alloy and shall have a powder coat finish.

1830 - Telescope On Wall

The Telescope shall be manufactured from UV-stabilized LLDPE (linear low-density polyethylene) with an average wall thickness of 1/4". The Telescope Mounting Bracket shall be precision laser-cut and formed from 3/16" sheet steel and will be Powder Coated as specified. The Telescope Disc Spacer Wall and Mounting Grip shall be made from high density 3/4" sheet plastic specially formulated for optimum UV-stability and color retention. The Telescope Lens Small and Large shall be fabricated using .118" thick Polycarbonate. The Telescope Swivel Bracket shall be 3-pieces precision laser-cut and welded together from 3/16" thick H.R. sheet steel and will be Powder Coated as specified.

1810 - Driver Wheel Assembly

The Driver Wheel Casting shall be precision die-cast from a high-strength aluminum alloy and will be Powder Coated as specified. The Spindle shall be machined from Ø 1" stainless steel. The Wheel Hub shall be machined from Ø 3-3/4" high strength aluminum alloy and will be Powder Coated as specified.

1807 STL - Steel Pyramid Roof

The Steel Pyramid Roof Post Bracket shall be formed from 10 gauge sheet steel and will be Powder Coated as specified. The Steel Pyramid Roof Section and Cap shall be formed from 14 gauge sheet steel and will be Powder Coated as specified.

1803 STL - Steel Hex Roof

The Steel Hex Roof Corner Bracket shall be formed from 10 gauge sheet steel and will be Powder Coated as specified. The Steel Hex Roof Section and Cap shall be formed from 14 gauge sheet steel and will be Powder Coated as specified.

1710 - Twister Slide

The Twister Slide shall be manufactured from UV-stabilized LLDPE (linear low-density polyethylene) with an average wall thickness of 1/4". The Single Slide Leg shall be fabricated of 1.660" O.D. 11 gauge tube steel welded onto a 10 gauge steel plate and will be Powder Coated as specified. The Twister Slide Support shall be fabricated of 1.660" O.D. 11 gauge tube steel welded onto a 3/16" steel plate and will be Powder Coated as specified.

1704 - Poly Wave Slide

The Poly Wave Slide shall be manufactured from UV-stabilized LLDPE (linear low-density polyethylene) with an average wall thickness of 1/4". The Single Slide Leg shall be fabricated of 1.660" O.D. 11 gauge tube steel welded onto a 10 gauge steel plate and will be Powder Coated as specified. The Slide Support shall be fabricated of 1.660" O.D. 11 gauge tube steel welded onto a 3/16" steel plate and will be Powder Coated as specified.

1702 - Double Slide

The Double Slide Spacer shall be fabricated using punched and formed 12 gauge sheet Steel and shall be Play-Tuff(TM) coated after fabrication. The Double Slide shall be manufactured from UV-stabilized LLDPE (linear low-density polyethylene) with an average wall thickness of 1/4". The Double Slide Leg shall be fabricated of 1.660" O.D. 11 gauge tube steel welded onto a 3/16" plate steel with a 5/8" steel rod welded to the base as a footing anchor and will be Powder Coated as specified. The Slide Support shall be fabricated of 1.660" O.D. 11 gauge steel tubing welded onto a 3/16" steel plate with a 5/8" steel rod welded to the base as a footing anchor and will be Powder Coated as specified.

1639 - Clubhouse Assembly

The Clubhouse Panels and Trim shall be made from high density 3/4" thick hot extruded sheet plastic specially formulated for optimum UV stability and color retention. The Clubhouse Table Support shall be fabricated using 1.660" O.D. steel tubing welded to a 1/4" thick pipe plug with threaded insert and will be Powder Coated as specified. The Store Panel Counter Bracket shall be precision laser cut and formed from 3/16" sheet steel and will be Powder Coated as specified. The Mounting Lugs and Socket Clamps shall be precision die-cast from a high strength aluminum alloy and will be Powder Coated as specified.

1618 - Seek Plaque Assembly

The Seek Panel Plaque shall be made from high-density 3/4" thick hot extruded polyethylene sheet plastic specially formulated for optimum UV stability and color retention.

1528 - Angled Net Link

The 16-Link Galvanized Chain shall be 5/0 galvanized low-carbon steel chain with silver shield finish. The Angled Net Link shall be made from 16mm steel-reinforced rope with high-strength copolymer plastic intersection connectors and machined aluminum end ferrules. The Angled Net Link Deck Connector shall be fabricated using 1/4" thick steel plate with welded 3/16" thick steel anchors and will be Powder Coated as specified.

1521 - Net Link

The Net Link shall be made from 16mm steel-reinforced rope with high-strength co-polymer plastic intersection connectors and machined aluminum end clevises. The Net Link Deck Connector shall be fabricated using 1/4" sheet steel with welded 3/16" thick steel anchors and will be Powder Coated as specified.

1414 1 - Lily Pad Seat-Step Assembly

The Lily Pad No Hole shall be constructed of UV-stabilized, rotationally molded, linear, low density polyethylene with an average wall thickness of .250". The Step Pad Step Leg shall be fabricated using 1.660" O.D. 11 gauge steel tubing with welded 1/4" thick steel mounting plate and will be Powder Coated as specified.

1400 - End Access Ladder

The End Access Ladder shall be fabricated using 1.315" OD, 12 gauge steel tubing and will be Powder Coated as specified. The Socket Clamps shall be two-part and precision die-cast from a high strength aluminum alloy and will be Powder Coated as specified.

1316 - Twister Entry Panel

The Twister Entry Panel shall be made from high density 3/4" sheet plastic specially formulated for optimum UV-Stability and color retention. The Mounting Lugs shall be precision die-cast from a high strength aluminum alloy and will be Powder Coated as specified.

1249 DDH DGH - Geo-Wave Climber Horizontal

The Geo-Wave Climber shall be constructed of UV-stabilized, rotationally molded, linear low density polyethylene with an average double wall thickness of .250". The Geo-Wave Deck Mount Bracket shall be formed from 1/4" thick sheet steel and will have a multi-stage baked-on powder coat finish. The Geo-Wave Climber Leg shall be fabricated using 1.029" O.D. 14 Gauge steel tubing with formed 1/4" thick end tab and will have a multi-stage baked-on powder coating. The Deck Filler shall be made from high density 3/4" sheet plastic specially formulated for optimum UV stability and color retention.

1219 - Deep Rung Arch Climber

The Arch Climber Deep Rung shall be fabricated from 1.660" O.D. 11 gauge steel tubing outer rails welded to 1/4" thick steel plates and 1.315" O.D. 12 gauge steel tubing rungs and will be Powder Coated as specified.

1209 - Transfer Station

The Steps & Decks shall be fabricated from 12 gauge punched sheet steel with reinforcing cross members and gussets. Each Step and Deck shall be Play-Tuff(TM) coated after fabrication. The Step Rails shall be fabricated from 1.315" O.D. 12 gauge and 1.660" O.D. 11 gauge steel tubing and will be powder coated as specified. The Step Deck Legs shall be fabricated from 1.660" O.D. 11 gauge steel tubing welded to a 10 gauge mounting bracket. The Step Deck Leg will be Powder Coated as specified.

1106 - Half Hex Deck 4 Post Assembly

The Half Hex Deck 4 Post shall be constructed using 12 gauge sheet steel which shall be formed and fabricated into required designs and punched with a uniform hole pattern and will be Play-Tuff(TM) coated after fabrication. The Mounting Blocks shall be two part and precision die-cast from a high strength aluminum alloy and will be Powder Coated as specified.

1101 - Square Deck Assembly

The Square Deck shall be constructed using 12 gauge sheet steel which shall be formed and fabricated into required designs and punched with a uniform hole pattern. The Decks will be Play-Tuff(TM) coated after fabrication. The Mounting Blocks shall be two part and precision die- cast from a high strength aluminum alloy. The Mounting Blocks will be Powder Coated as specified.

PLAY EQUIPMENT SPECIFICATIONS – INDIVIDUAL EQUIPMENT

PC-2123-R3.5 Arched Swing Bays

The Swing Arch & Swing Beam shall be fabricated using 3.5" O.D. 11 gauge galvanized steel tubing and will be powder Coated as specified. The Arch Swing Casting and Arch Swing Washer shall be cast from a high-strength aluminum alloy and will be Powder Coated as specified. The Swing Chain shall be 7 mm (1/4") PC Grade 30 chain with a silver shield cold galvanized finish. The Swing Seats shall be molded from a UV-stabilized flexible rubber compound with slash-proof, reinforced metal Inserts. Inclusive Swing Seat & Harness shall be constructed of UV-stabilized, rotationally molded, linear, low density polyethylene with an average wall thickness of .250". The Pivot Cap, Pivot Spacer, Latch Cap, Latch Housing, Latch Handle, Latch, Latch Spacer, Vent Plug shall be made from high density 3/4" sheet plastic specially formulated for optimum UV stability and color retention.

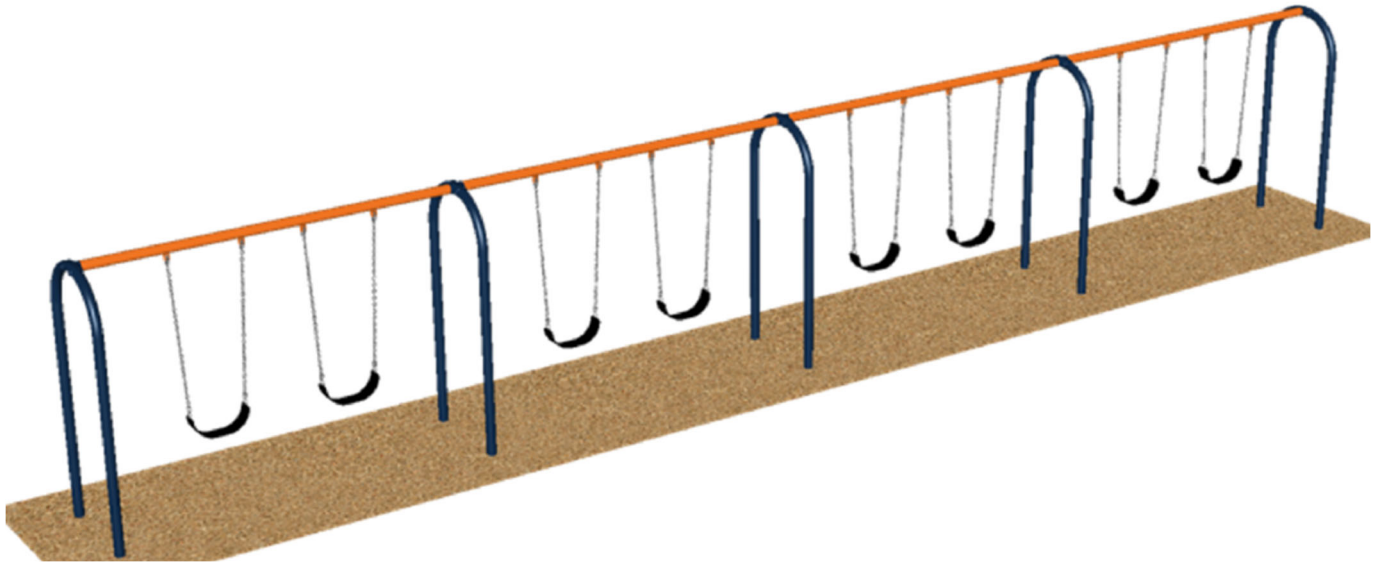

APS Swing Mats – One Per Swing

3'x5'x2" Swing Wear Mat, 100% Compressed Rubber Mats, 135 lbs per mat

PC-4286 - Bench w/ Back (Quantity – 2)

The Bench Divider shall be fabricated using 1.029" O.D. 14 gauge steel tubing with welded 1/4" thick steel mounting brackets and will be Powder Coated as specified. The Bench Top shall be fabricated using punched, formed and welded 14 gauge sheet steel and shall be Play-Tuff(TM) coated after fabrication. The Bench Frame In-Ground Leg shall be fabricated using 2.375" O.D. 11 gauge steel tubing with welded 10 gauge steel mounting plate and will be Powder Coated as specified. The Bench Frame Surface Mount shall be fabricated using 2.375" O.D. 11 gauge steel tubing with welded .5" x 3" rectangular tube steel and welded 10 gauge steel mounting plates and will be Powder Coated as specified.

